



Bobcat®

EN

Operation & Maintenance Manual E17 Compact Excavator

S/N B27H11001 & Above

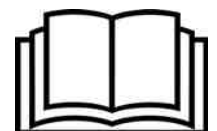
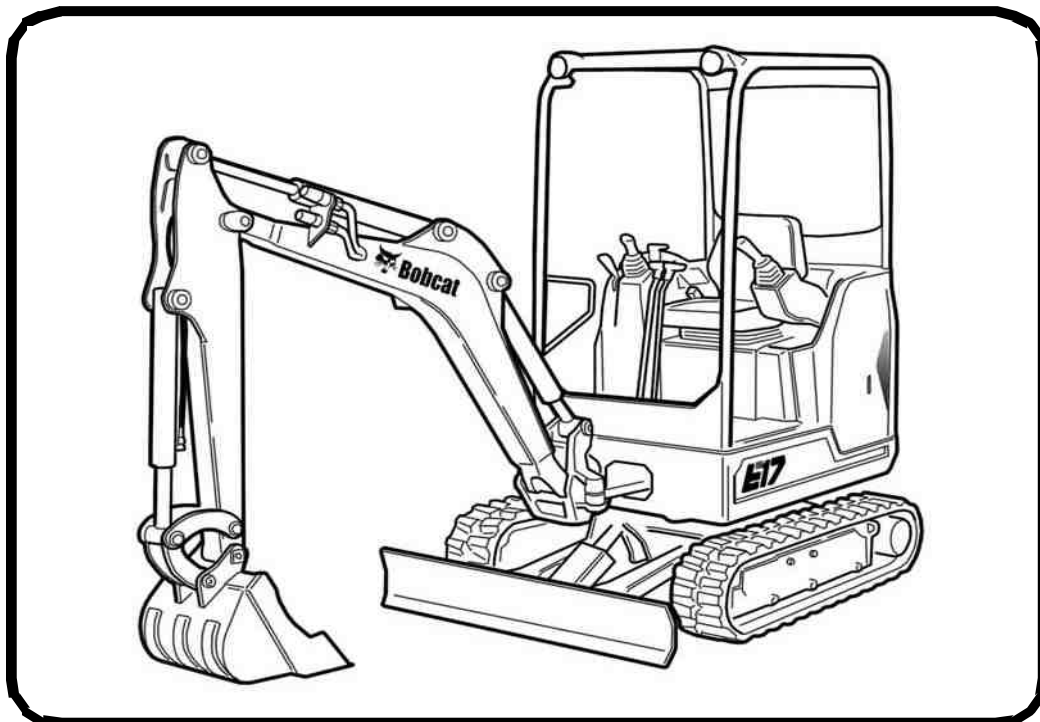





OPERATOR SAFETY WARNING

⚠ WARNING

Operator must have instructions before operating the machine. Untrained operators can cause injury or death.

W-2001-0502

⚠ Safety Alert Symbol: This symbol with a warning statement, means: "Warning, be alert! Your safety is involved!" Carefully read the message that follows.

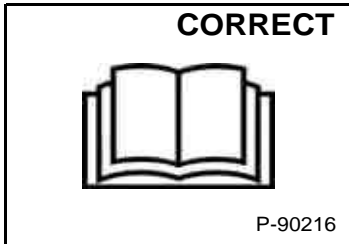

- ⚠ Never operate without instructions.
- ⚠ Read machine signs, and Operation & Maintenance Manual, and Operator's Handbook.

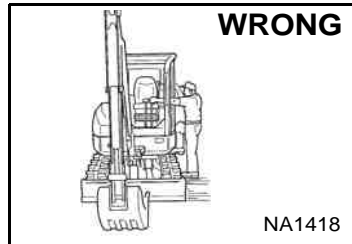

- ⚠ Do not grasp control handles when entering cab / canopy.
- ⚠ Be sure controls are in neutral before starting.
- ⚠ Sound horn and check behind machine before starting.

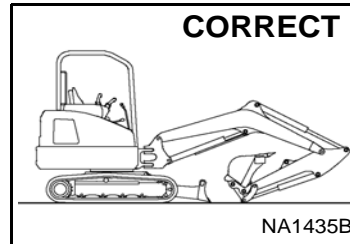

- ⚠ Never operate without approved cab / canopy.
- ⚠ Never modify equipment.
- ⚠ Never use attachments not approved by Bobcat Company.

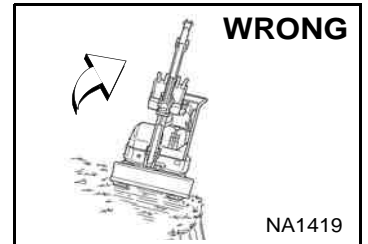

- ⚠ Avoid steep areas or banks that could break away.

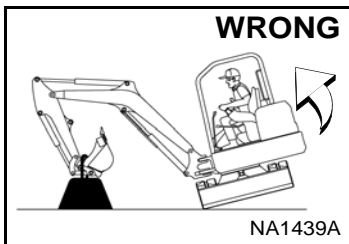

- ⚠ Use caution to avoid tipping - do not swing heavy load over side of track.
- ⚠ Operate on flat, level ground.

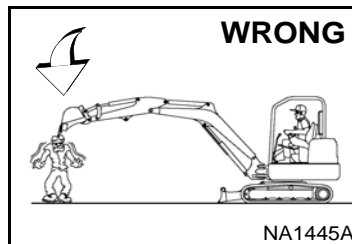

- ⚠ Keep bystanders out of maximum reach area.
- ⚠ Do not travel or turn with bucket extended.
- ⚠ Never carry riders.

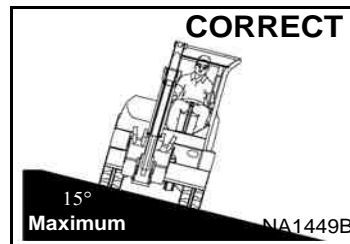

- ⚠ Never exceed a 15° slope to the side.

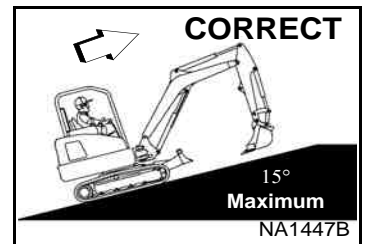

- ⚠ Never travel up a slope that exceeds 15°.

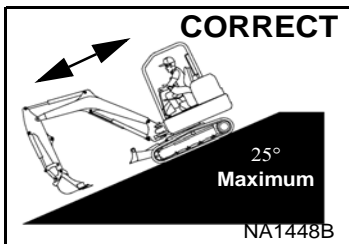

- ⚠ Never exceed 25° when going down or backing up a slope.

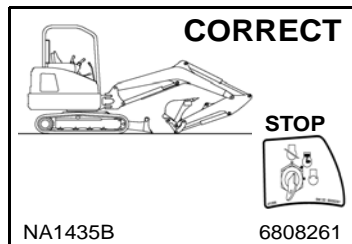

- ⚠ To leave excavator, lower the work equipment and the blade to the ground.
- ⚠ Stop the engine.

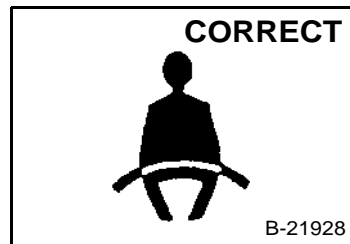

- ⚠ Fasten seat belt securely.
- ⚠ Operate controls only from operator's seat.

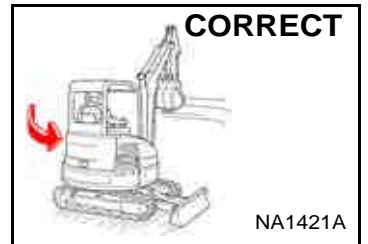

- ⚠ Look in the direction of rotation and make sure no bystanders are in the work area.

SAFETY EQUIPMENT

The excavator must be equipped with safety items necessary for each job. Ask your dealer about attachments and accessories.

1. SEAT BELT: Check belt fasteners and check for damaged webbing or buckle.
2. OPERATOR CAB / CANOPY (ROPS and TOPS): Check condition and mounting hardware.
3. OPERATOR'S HANDBOOK: Must be in the cab / canopy.
4. LEFT HAND CONSOLE: When raised must deactivate the travel and hydraulic functions.
5. SAFETY SIGNS (DECALS): Replace if damaged.
6. GRAB HANDLES: Replace if damaged.
7. INTEGRATED SLEW LOCK BRAKE.
8. SAFETY TREAD.: Replace if damaged.

OSW66-EN-0409



Bobcat®



CONTENTS

CONTENTS	3
FOREWORD	5
SAFETY AND TRAINING RESOURCES	15
OPERATING INSTRUCTIONS	29
PREVENTIVE MAINTENANCE	99
SYSTEM SETUP AND ANALYSIS	145
SPECIFICATIONS	155
WARRANTY	167
ALPHABETICAL INDEX	171

REFERENCE INFORMATION

Write the correct information for YOUR Bobcat excavator in the spaces below. Always use these numbers when referring to your Bobcat excavator.

Excavator Serial
Number

Engine Serial Number

NOTES:

YOUR BOBCAT DEALER:

ADDRESS:

PHONE:



Bobcat Company
P.O. Box 128
Gwinner, ND 58040-0128
UNITED STATES OF AMERICA

Doosan Benelux SA
Drève Richelle 167
B-1410 Waterloo
BELGIUM



Bobcat®



FOREWORD

This Operation & Maintenance Manual was written to give the owner / operator instructions on the safe operation and maintenance of the Bobcat excavator. **READ AND UNDERSTAND THIS OPERATION & MAINTENANCE MANUAL BEFORE OPERATING YOUR BOBCAT EXCAVATOR.** If you have any questions, see your Bobcat dealer. This manual may illustrate options and accessories not installed on your excavator.

DECLARATION OF CONFORMITY	7
For Model E17	7
BOBCAT COMPANY IS ISO 9001 CERTIFIED	9
REGULAR MAINTENANCE ITEMS	9
LUBRICANTS AND FLUIDS	10
SERIAL NUMBER LOCATIONS	11
Excavator Serial Number	11
Engine Serial Number	11
DELIVERY REPORT	11
EXCAVATOR IDENTIFICATION	12
FEATURES, ACCESSORIES AND ATTACHMENTS	13
Standard Items	13
Options And Accessories	13
Attachments	13
Buckets Available	13
Falling-Object Guards (FOGS)	14
Special Applications Kit	14
Special Applications Kit Inspection And Maintenance	14



Bobcat®



DECLARATION OF CONFORMITY

For Model E17

Contents of EC Declaration of Conformity

This information is provided in the operators manual to comply with clause 1.7.4.2(c) of Annex I of Machinery Directive 2006/42/EC.

The official EC Declaration of Conformity is supplied in a separate document.

<p>Manufacturer</p>  <p>Bobcat Company World Headquarters 250 East Beaton Drive West Fargo, ND 58078-6000 UNITED STATES OF AMERICA</p>	<p>Directive 2000/14/EC: Noise Emission in the Environment by Equipment For Use Outdoors</p> <p>Notified Body Technical and Test Institute for Construction Prague, Czech Republic Notified Body Number: 1020</p> <p>EC Certificate No. 1020-090-022395</p> <p>Conformity Assessment Procedure(s) 2000/14/EC, Annex VIII, Full Quality Assurance</p> <p>Sound Power Levels [Lw(A)]</p> <table border="0"> <tr> <td>Measured Sound Power</td> <td style="text-align: right;">92dBA</td> </tr> <tr> <td>Guaranteed Sound Power</td> <td style="text-align: right;">93dBA</td> </tr> </table>	Measured Sound Power	92dBA	Guaranteed Sound Power	93dBA
Measured Sound Power	92dBA				
Guaranteed Sound Power	93dBA				
<p>Technical Documentation Doosan Benelux SA Drève Richelle 167 B-1410 Waterloo BELGIUM</p>	<p>Equipment conforms to CE Directive(s) Listed Below 2006/42/EC: Machinery Directive 2004/108/EC: Electromagnetic Compatibility Directive</p>				
<p>Description of Equipment Type of Equipment: Excavator Model Name: E17 Model Code: B27H</p> <p>Engine Manufacturer: Kubota Engine Model: D722-E2B-BCZ-7 Engine Power: 10,2 kW @ 2500 RPM</p>					
<p>Declaration of Conformance This equipment conforms to the requirements specified in all the EC Directives listed in this declaration.</p>					
<p>Effective From: 29 June 2011</p>					



Bobcat®



BOBCAT COMPANY IS ISO 9001 CERTIFIED











ISO 9001 is an international standard that specifies requirements for a quality management system that controls the processes and procedures which we use to design, develop, manufacture and distribute Bobcat products.

British Standards Institute (**BSI**) is the Certified Registrar Bobcat Company chose to assess the Company's compliance with the ISO 9001 at Bobcat's manufacturing facilities in Gwinner and Bismarck, North Dakota (U.S.A.), Pontchateau (France), Dobris (Czech Republic) and the Bobcat corporate offices (Gwinner, Bismarck & West Fargo) in North Dakota. Only certified assessors, like BSI, can grant registrations.

ISO 9001 means that as a company we say what we do and do what we say. In other words, we have established procedures and policies, and we provide evidence that the procedures and policies are followed.

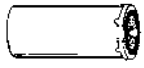
REGULAR MAINTENANCE ITEMS

	ENGINE OIL FILTER 6671057		BATTERY 6670251
	FUEL FILTER 6667352 FUEL FILTER - Pre-Filter 7247169		HYDRAULIC FILL / BREATHER CAP 6692836
 	AIR FILTER, Outer 6673752 AIR FILTER, Inner 6673753		FLUID, Hydraulic / Hydrostatic 6903117 - 9,5 L (2.5 U.S. gal) 6903118 - 18,9 L (5 U.S. gal) 6903119 - 208 L (55 U.S. gal)
	PRIMARY HYDRAULIC FILTER 6661248		ANTI-FREEZE, Propylene Glycol 6983128 - Premixed 6983129 - Concentrate
			RADIATOR CAP 7257434

NOTE: Always verify Part Numbers with your Bobcat dealer.

SERIAL NUMBER LOCATIONS

Always use the serial number of the excavator when requesting service information or when ordering parts. Early or later models (identification made by serial number) may use different parts, or it may be necessary to use a different procedure in doing a specific service operation.

Excavator Serial Number

Figure 1



The excavator serial number plate (Item 1) [Figure 1] is located on the frame of the machine in the location shown.

Figure 2

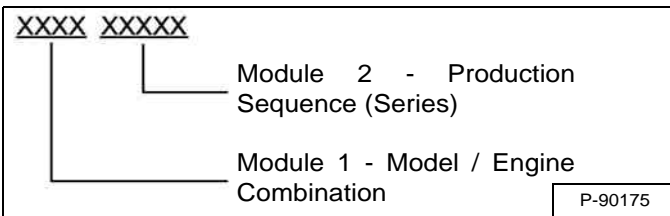

Explanation of excavator Serial Number [Figure 2]:

1. The four digit Model / Engine Combination Module number identifies the model number and engine combination.
2. The five digit Production Sequence Number identifies the order which the excavator is produced.

Engine Serial Number

Figure 3

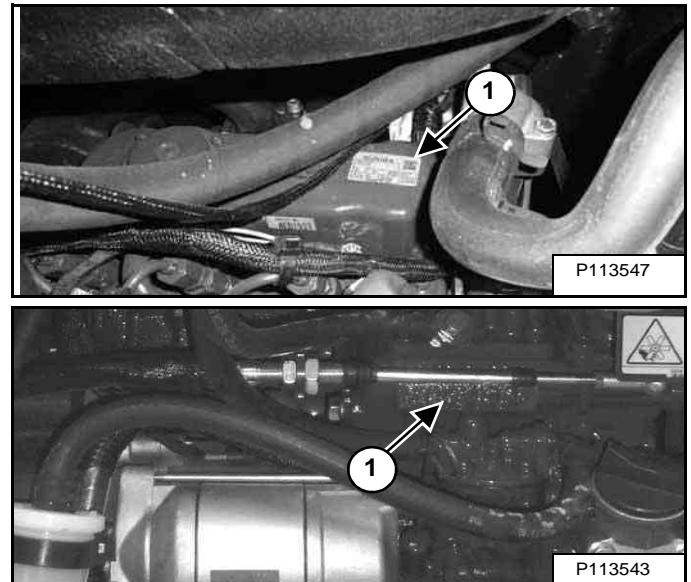

The engine serial number is located on the top cover (Item 1) or on the side of the engine block (Item 2) [Figure 3] above the fuel pump.

DELIVERY REPORT

Figure 4

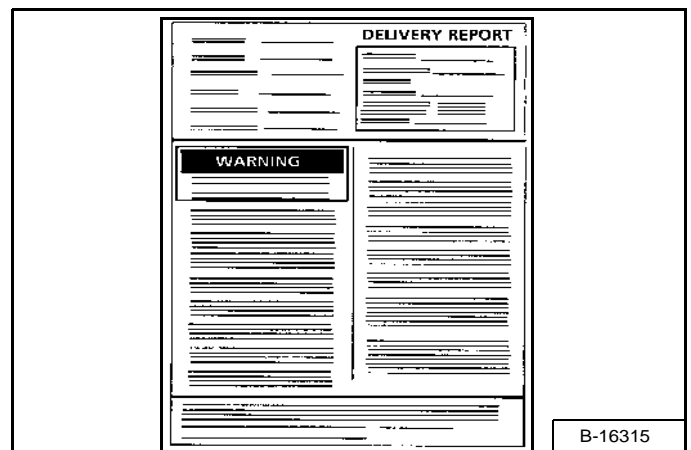

The delivery report [Figure 4] contains a list of items that must be explained or shown to the owner or operator by the dealer when the Bobcat excavator is delivered.

The delivery report must be reviewed and signed by the owner or operator and the dealer.

EXCAVATOR IDENTIFICATION

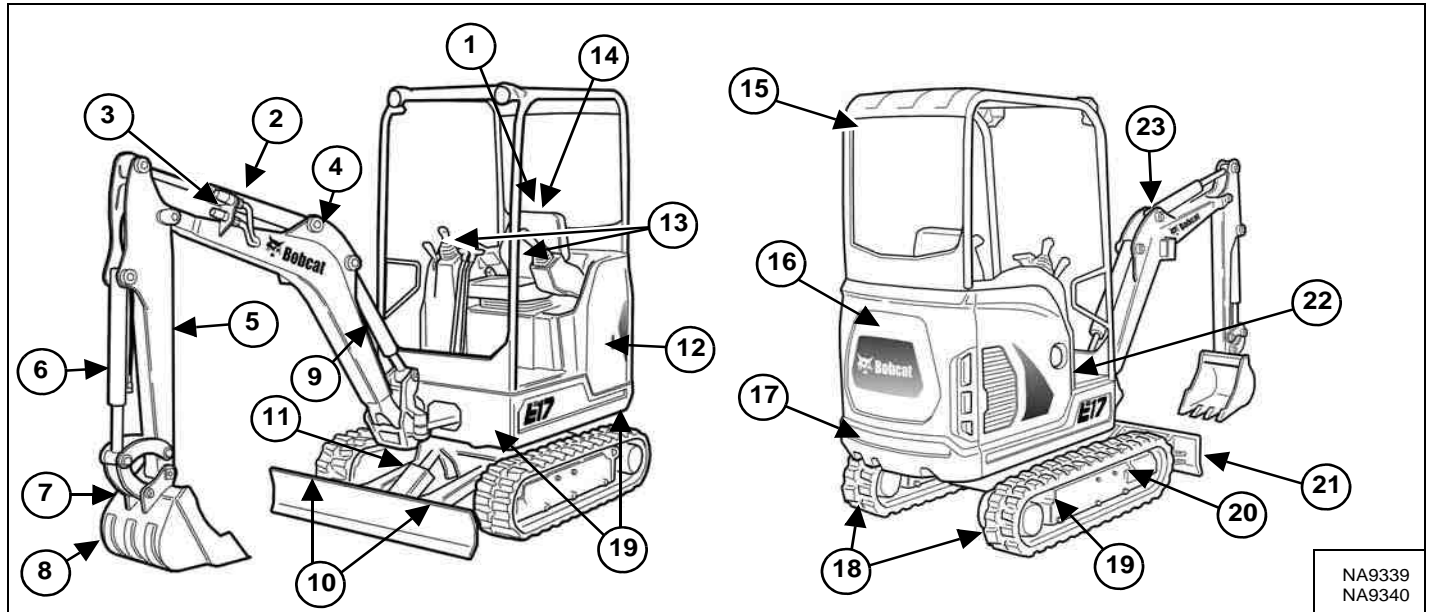

ITEM	DESCRIPTION	ITEM	DESCRIPTION
1	Operator's Handbook	15	Cab / Canopy (ROPS / TOPS) [B]
2	Arm Cylinder	16	Rear Cover
3	Auxiliary Quick Couplers	17	Counterweight
4	Boom	18	Tracks
5	Arm	19	Tie Downs (Both Sides)
6	Bucket Cylinder	20	Track Frames
7	Bucket Link / Attachment Coupler (If Equipped)	21	Blade
8	Bucket [A]	22	Right Side Cover
9	Boom Cylinder	23	Lift Point
10	Tie Downs / Lift Points		
11	Blade Cylinder		
12	Upperstructure		
13	Control Levers (Joysticks)		
14	Operator's Seat with Seat Belt		

- [A] BUCKET - Several different buckets and other attachments are available for the Bobcat excavator.
 [B] ROPS, TOPS - (Roll-Over Protective Structure / Tip-Over Protective Structure) as standard equipment. The ROPS / TOPS meets ISO 12117-2 AND ISO 12117.



FEATURES, ACCESSORIES AND ATTACHMENTS

Standard Items

Model E17 Bobcat excavators are equipped with the following standard items:

- Canopy with ROPS / TOPS Approval
- Rubber Tracks 230 mm (9.0 in)
- Dozer Blade 1360 mm (53.5 in) (Including extensions)
- Auxiliary Hydraulics On Boom (Double Acting)
- Hydraulic Joystick Controls
- Engine Speed Control Lever
- Hydraulic and Travel Control Lockouts
- Hydraulic Retractable Undercarriage (1360 mm to 980 mm)
- Track Retraction - Expansion Valve / Switch
- Two-Speed Travel
- Engine with Shut Down
- Work Light - Boom Mounted
- Horn
- Stationary Seat
- Retractable Seat Belt
- Spark Arrester Muffler
- Advanced Diagnostics
- Counterweight
- Battery Kill Switch
- Upperstructure with Four Point Tie Down

Options And Accessories

Below is a list of some equipment available from your Bobcat excavator dealer as Dealer and / or Factory Installed Accessories and Factory Installed Options. See your Bobcat dealer for other available options, accessories and attachments.

- Auto Shift Drive Motors
- Auxiliary Hydraulics On Arm
- Enclosed Cab With Heater
- Travel Motion Alarm
- Keyless Start
- Canopy / Cab Mounted Lights
- Long Dozer Blade
- Long Arm
- Top Guard Kit (FOGS)
- Special Application Kit
- Attachment Mounting Coupler (Klac or Lehnhoff)
- Object Handling Certified (boom / arm load holding valves, overload warning and lift eye)
- Load Holding Valve - Boom
- Load Holding Valve - Arm
- Lift Eye
- Adjustable Seat or Suspension Seat
- Strobe Light
- Side Mirror
- Fire Extinguisher
- Radio
- Additional Counterweight

Specifications subject to change without notice and standard items can vary.

Attachments

These and other attachments are approved for use on this model Bobcat excavator. Do not use unapproved attachments. Attachments not manufactured by Bobcat can not be approved.

The versatile Bobcat excavator quickly turns into a multi-job machine with a variety of attachments.

See your Bobcat dealer for information about approved attachments and attachment Operation & Maintenance Manuals.

- Auger
- Breaker
- Hydraulic Clamp
- Laser Receiver
- Reverse Coupler
- Tilt Bucket

Buckets Available

Increase the versatility of your Bobcat excavator with a variety of bucket sizes.

Many bucket styles, widths and different capacities are available for a variety of different applications. They include Trenching, Digging, Grading, Tilt, to name a few. See your Bobcat dealer for the correct bucket for your Bobcat excavator and application.

FEATURES, ACCESSORIES AND ATTACHMENTS (CONT'D)

Falling-Object Guards (FOGS)

Figure 5

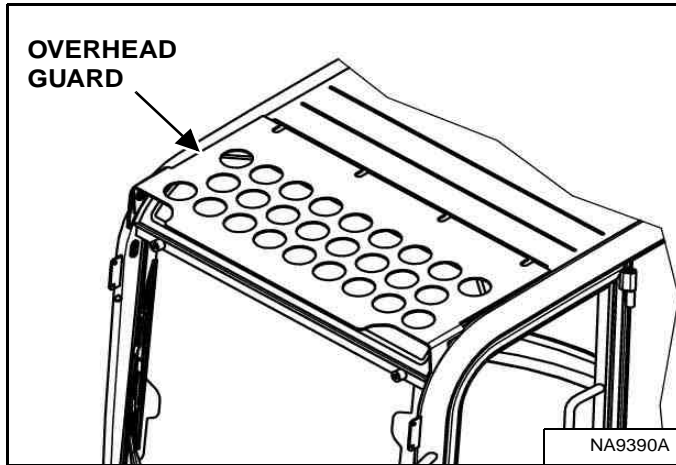

Available for special applications that require protection from smaller objects that can fall on the canopy / cab or restrict material from entering canopy / cab openings [Figure 5] and [Figure 6].

The excavator must have the overhead guard [Figure 5] installed to meet the top guard requirements in ISO 10262.

See your Bobcat Dealer for more information.

NOTE: The Falling-Object Guard is factory installed on the canopy.

Special Applications Kit

Figure 6

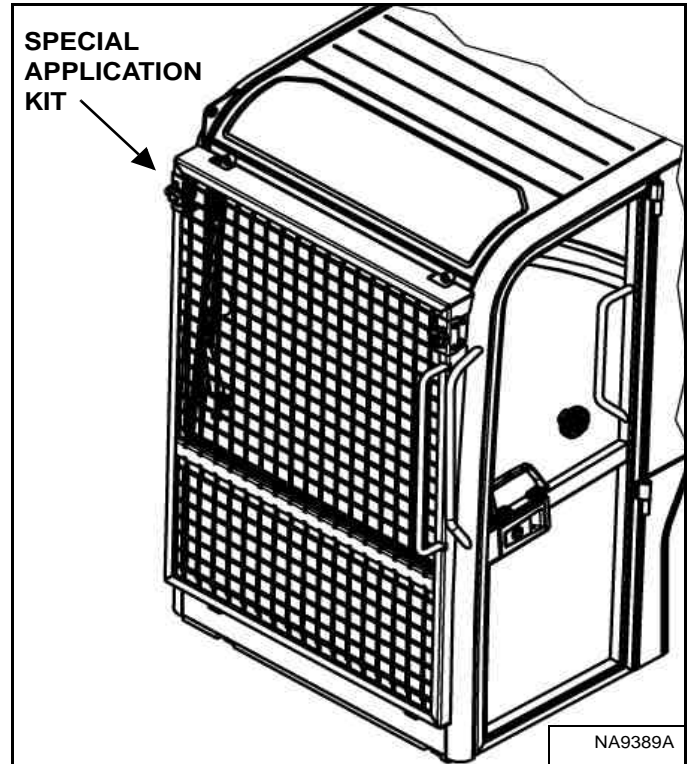

The excavator must have the special applications kit [Figure 6] installed to meet the front guard requirements in ISO 10262 - level 1.

Kit includes an upper and lower screen guard.

See your Bobcat Dealer for more information.

Special Applications Kit Inspection And Maintenance

The Special Applications Kit must be regularly inspected and maintained. Inspect the screen for damage. Replace parts as necessary.



SAFETY AND TRAINING RESOURCES

SAFETY INSTRUCTIONS	17
Before Operation	17
Safe Operation Is The Operator's Responsibility	18
Safe Operation Needs A Qualified Operator	18
Avoid Silica Dust	19
FIRE PREVENTION	19
Maintenance	19
Operation	19
Electrical	19
Hydraulic System	20
Fueling	20
Starting	20
Spark Arrester Exhaust System	20
Welding And Grinding	20
Fire Extinguishers	20
PUBLICATIONS AND TRAINING RESOURCES	21
MACHINE SIGNS (DECALS)	22
Pictorial Only Safety Signs	24



Bobcat®



SAFETY INSTRUCTIONS

Before Operation

Carefully follow the operating and maintenance instructions in this manual.

The Bobcat excavator is highly manoeuvrable and compact. It is rugged and useful under a wide variety of conditions. This presents an operator with hazards associated with off motorway, rough terrain applications, common with Bobcat excavator usage.

The Bobcat excavator has an internal combustion engine with resultant heat and exhaust. All exhaust gases can kill or cause illness so use the excavator with adequate ventilation.

The dealer explains the capabilities and restrictions of the Bobcat excavator and attachment for each application. The dealer demonstrates the safe operation according to Bobcat instructional materials, which are also available to operators. The dealer can also identify unsafe modifications or use of unapproved attachments. The attachments and buckets are designed for a Rated Lift Capacity. They are designed for secure fastening to the Bobcat excavator. The user must check with the dealer, or Bobcat literature, to determine safe loads of materials of specified densities for the machine - attachment combination.

The following publications and training materials provide information on the safe use and maintenance of the Bobcat machine and attachments:

- The Delivery Report is used to assure that complete instructions have been given to the new owner and that the machine and attachment is in safe operating condition.
- The Operation & Maintenance Manual delivered with the machine or attachment gives operating information as well as routine maintenance and service procedures. It is a part of the machine and can be stored in a container provided on the machine. Replacement Operation & Maintenance Manuals can be ordered from your Bobcat dealer.
- Machine signs (decals) instruct on the safe operation and care of your Bobcat machine or attachment. The signs and their locations are shown in the Operation & Maintenance Manual. Replacement signs are available from your Bobcat dealer.
- An Operator's Handbook is fastened to the operator cab of the excavator. Its brief instructions are convenient to the operator. See your Bobcat dealer for more information on translated versions.

The dealer and owner / operator review the recommended uses of the product when delivered. If the owner / operator will be using the machine for a different application(s) he or she must ask the dealer for recommendations on the new use.



SAFETY INSTRUCTIONS (CONT'D)

Safe Operation Is The Operator's Responsibility

Safety Alert Symbol

This symbol with a warning statement means:
"Warning, be alert! Your safety is involved!"
Carefully read the message that follows.

WARNING

Operator must have instructions before operating the machine. Untrained operators can cause injury or death.

W-2001-0502

IMPORTANT

This notice identifies procedures which must be followed to avoid damage to the machine.

I-2019-0284

DANGER

The signal word DANGER on the machine and in the manuals indicates a hazardous situation which, if not avoided, will result in death or serious injury.

D-1002-1107

WARNING

The signal word WARNING on the machine and in the manuals indicates a potentially hazardous situation which, if not avoided, could result in death or serious injury.

W-2044-1107

The Bobcat excavator and attachment must be in good operating condition before use.

Check all of the items on the Bobcat Service Schedule Decal under the 8-10 hour column or as shown in the Operation & Maintenance Manual.

Safe Operation Needs A Qualified Operator

For an operator to be qualified, he or she must not use drugs or alcoholic drinks which impair alertness or coordination while working. An operator who is taking prescription drugs must get medical advice to determine if he or she can safely operate a machine.

A Qualified Operator Must Do The Following:

Understand the Written Instructions, Rules and Regulations

- The written instructions from Bobcat Company include the Delivery Report, Operation & Maintenance Manual, Operator's Handbook and machine signs (decals).
- Check the rules and regulations at your location. The rules may include an employer's work safety requirements. For driving on public roads, the machine must be equipped as stipulated by the local regulations authorising operation on public roads in your specific country. Regulations may identify a hazard such as a utility line.

Have Training with Actual Operation

- Operator training must consist of a demonstration and verbal instruction. This training is given by your Bobcat dealer before the product is delivered.
- The new operator must start in an area without bystanders and use all the controls until he or she can operate the machine and attachment safely under all conditions of the work area. Always fasten seat belt before operating.

Know the Work Conditions

- Know the weight of the materials being handled. Avoid exceeding the Rated Lift Capacity of the machine. Material which is very dense will be heavier than the same volume of less dense material. Reduce the size of load if handling dense material.
- The operator must know any prohibited uses or work areas, for example, he or she needs to know about excessive slopes.
- Know the location of any underground lines.
- Wear tight fitting clothing. Always wear safety glasses when doing maintenance or service. Safety glasses, respiratory equipment, hearing protection or Special Applications Kits are required for some work. See your Bobcat dealer about Bobcat Safety Equipment for your model.

SAFETY INSTRUCTIONS (CONT'D)

Avoid Silica Dust

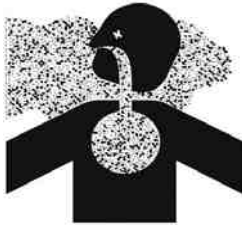

Cutting or drilling concrete containing sand or rock containing quartz may result in exposure to silica dust. Use a respirator, water spray or other means to control dust.

FIRE PREVENTION



Maintenance

The machine and some attachments have components that are at high temperatures under normal operating conditions. The primary source of high temperatures is the engine and exhaust system. The electrical system, if damaged or incorrectly maintained, can be a source of arcs or sparks.

Flammable debris (leaves, straw, etc.) must be removed regularly. If flammable debris is allowed to accumulate, it can cause a fire hazard. Clean often to avoid this accumulation. Flammable debris in the engine compartment is a potential fire hazard.

The operator's area, engine compartment and engine cooling system must be inspected every day and cleaned if necessary to prevent fire hazards and overheating.

All fuels, most lubricants and some coolants mixtures are flammable. Flammable fluids that are leaking or spilled onto hot surfaces or onto electrical components can cause a fire.

Operation

Do not use the machine where exhaust, arcs, sparks or hot components can contact flammable material, explosive dust or gases.

Electrical



Check all electrical wiring and connections for damage. Keep the battery terminals clean and tight. Repair or replace any damaged part or wires that are loose or frayed.

Battery gas can explode and cause serious injury. Use the procedure in the Operation & Maintenance Manual for connecting the battery and for jump starting. Do not jump start or charge a frozen or damaged battery. Keep any open flames or sparks away from batteries. Do not smoke in battery charging area.



FIRE PREVENTION (CONT'D)

Hydraulic System

Check hydraulic tubes, hoses and fittings for damage and leakage. Never use open flame or bare skin to check for leaks. Hydraulic tubes and hoses must be properly routed and have adequate support and secure clamps. Tighten or replace any parts that show leakage.

Always clean fluid spills. Do not use petrol or diesel fuel for cleaning parts. Use commercial non-flammable solvents.

Fueling



Stop the engine and let it cool before adding fuel. No smoking! Do not refuel a machine near open flames or sparks. Fill the fuel tank outdoors.

Ultra Low Sulfur Diesel (ULSD) poses a greater static ignition hazard than earlier diesel formulations with higher Sulfur content. Avoid death or serious injury from fire or explosion. Consult with your fuel or fuel system supplier to ensure the delivery system is in compliance with fueling standards for proper grounding and bonding practices.

Starting

Do not use ether or starting fluids on any engine that has glow plugs. These starting aids can cause explosion and injure you or bystanders.

Use the procedure in the Operation & Maintenance Manual for connecting the battery and for jump starting.

Spark Arrester Exhaust System

The spark arrester exhaust system is designed to control the emission of hot particles from the engine and exhaust system, but the muffler and the exhaust gases are still hot.

Check the spark arrester exhaust system regularly to make sure it is maintained and working properly. Use the procedure in the Operation & Maintenance Manual for cleaning the spark arrester muffler (if equipped).

Welding And Grinding

Always clean the machine and attachment, disconnect the battery, and disconnect the wiring from the Bobcat controllers before welding. Cover rubber hoses, battery and all other flammable parts. Keep a fire extinguisher near the machine when welding.

Have good ventilation when grinding or welding painted parts. Wear dust mask when grinding painted parts. Toxic dust or gas can be produced.

Dust generated from repairing non-metallic parts such as hoods, fenders or covers can be flammable or explosive. Repair such components in a well ventilated area away from open flames or sparks.

Fire Extinguishers

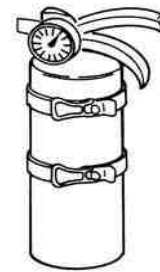

Know where fire extinguishers and first aid kits are located and how to use them. Inspect the fire extinguisher and service the fire extinguisher regularly. Obey the recommendations on the instructions plate.

PUBLICATIONS AND TRAINING RESOURCES

The following publications are also available for your Bobcat excavator. You can order them from your Bobcat dealer.

For the latest information on Bobcat products and the Bobcat Company, visit our Web site at www.bobcat.eu.

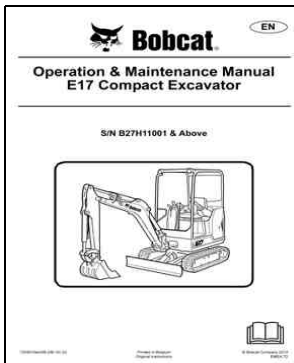

OPERATION & MAINTENANCE MANUAL

7255010enGB

Complete instructions on the correct operation and the routine maintenance of the Bobcat excavator.

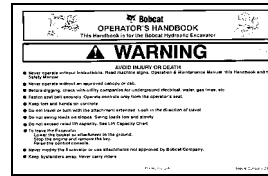

OPERATOR'S HANDBOOK

7255186enGB

Gives basic operation instructions and safety warnings.

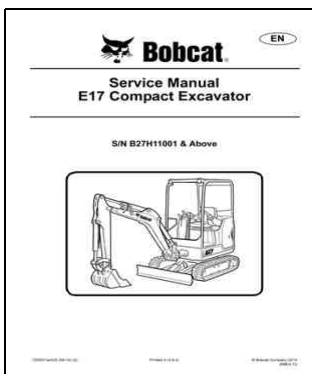

SERVICE MANUAL

7255011enUS

Complete maintenance instructions for your Bobcat excavator.



MACHINE SIGNS (DECALS) (CONT'D)

Follow the instructions on all the Machine Signs (Decals) that are on the excavator. Replace any damaged machine signs and be sure they are in the correct locations. Machine signs are available from your Bobcat excavator dealer.

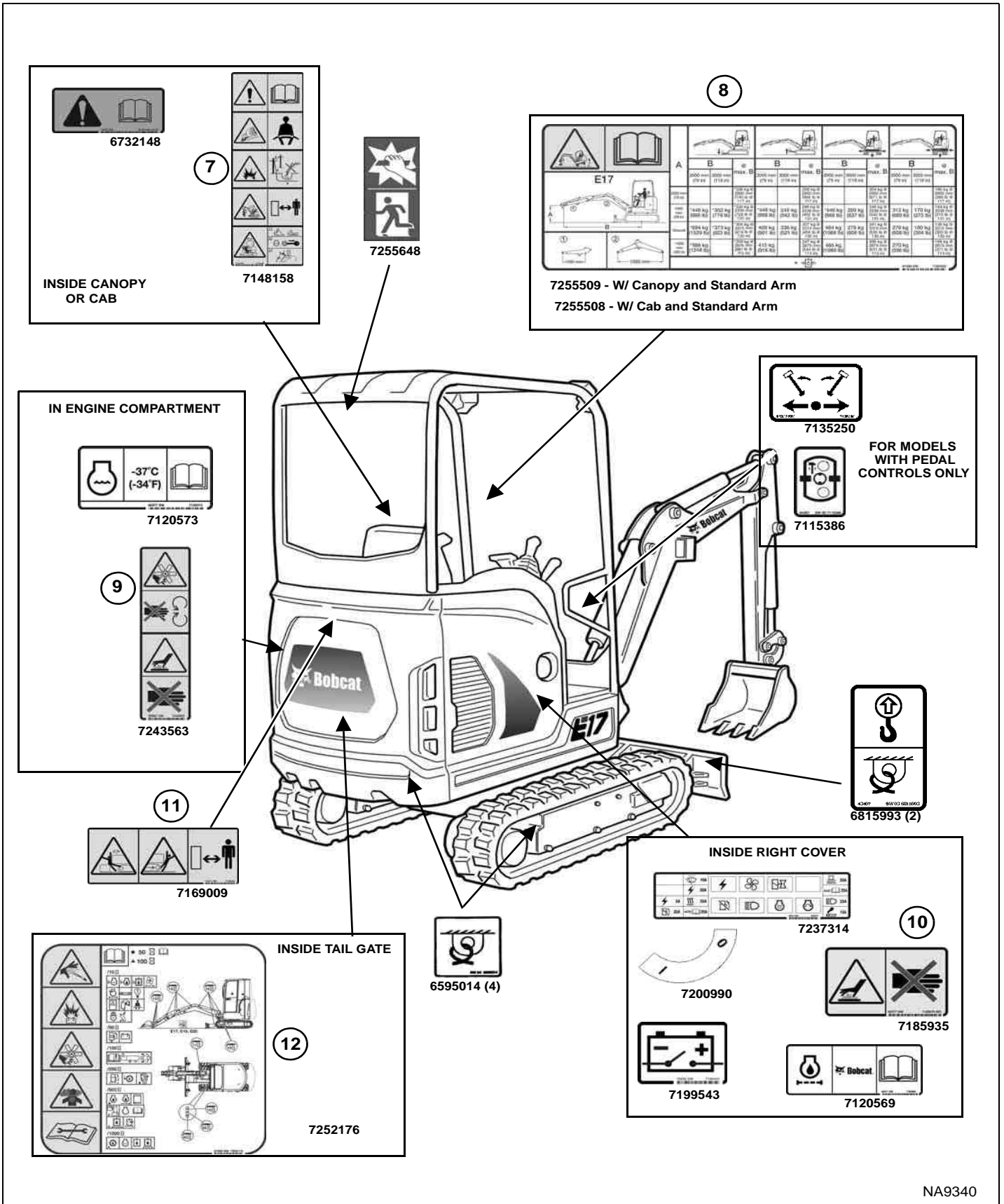



MACHINE SIGNS (DECALS) (CONT'D)

Pictorial Only Safety Signs

Safety signs are used to alert the equipment operator or maintenance person to hazards that may be encountered in the use and maintenance of the equipment. The location and description of the safety signs are detailed in this section. Please become familiarised with all safety signs installed on the excavator.

Vertical Configuration

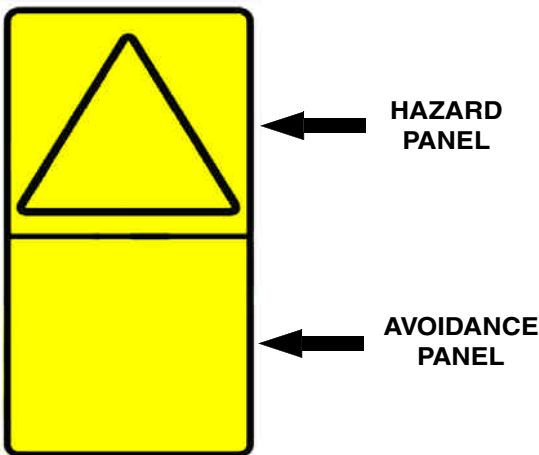

Horizontal Configuration

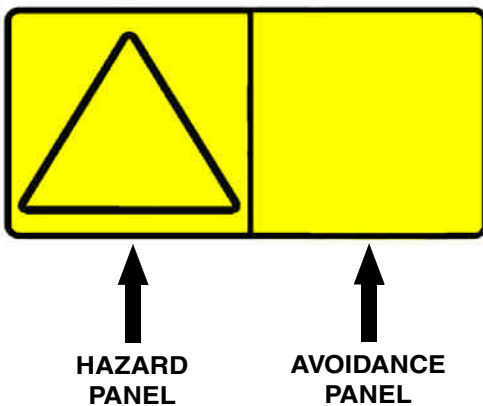

The format consists of the hazard panel(s) and the avoidance panel(s):

Hazard panels depict a potential hazard enclosed in a safety alert triangle.

Avoidance panels depict actions required to avoid the hazards.

A safety sign may contain more than one hazard panel and more than one avoidance panel.

NOTE: See the numbered MACHINE SIGNS (DECALS) on Page 22 and Machine Signs (Decals) (Cont'd) on Page 23 for the machine location of each corresponding numbered pictorial only decals as shown below.

1. Motion Alarm (7136738)

This safety sign is located on the right window (cab models), rear crossmember (canopy models).



**This machine is equipped with a motion alarm.
ALARM MUST SOUND!
when operating forward or backward.**

Failure to maintain a clear view in the direction of travel could result in serious injury or death.

The operator is responsible for the safe operation of this machine.

W-2786-0309



MACHINE SIGNS (DECALS) (CONT'D)

Pictorial Only Safety Signs (Cont'd)

2. Control Pattern / Joystick (7251802, 7255944)

This safety signs are located on the left console by the seat and on both consoles by the joysticks.

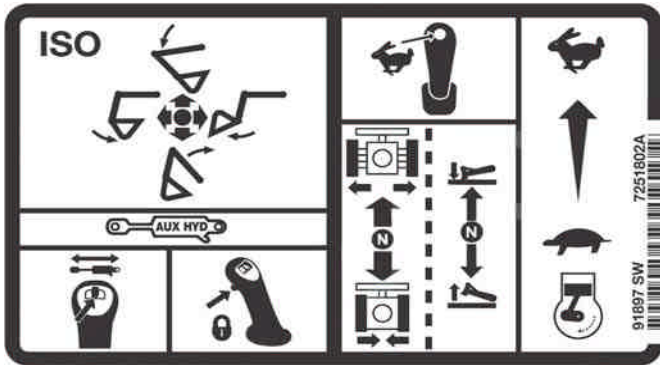

Know the control pattern before operating.

W-2989-0714

3. Crush Hazard (6713507)

This safety sign is located on both sides of the boom.



Keep away from the operating machine to avoid serious injury or death.

W-2520-0106

4. Thrown Or Flying Objects (7168039)

This safety sign is located on the outside of both track frame.



High pressure grease can cause serious injury. Do not loosen grease fitting. Do not loosen bleed fitting more than 1 - 1/2 turns.

Read and understand the Operation & Maintenance Manual for more information.

W-2516-0110

MACHINE SIGNS (DECALS) (CONT'D)

Pictorial Only Safety Signs (Cont'd)

5. Transporting And Lifting (7178215)

This safety sign is located on the front of the cab.



Improper loading, transporting and lifting procedures can cause serious injury or death. Read and understand the Operation & Maintenance Manual prior to transporting or lifting the machine.

W-2517-0110

6. Transporting And Lifting (7120578)

This safety sign is located on the front of the cab.



- Keep out of swing area.
- Keep bystanders away.
- Operate the excavator from the operator's position only.

W-2990-0714

7. General Hazard (7148158)

This safety sign is located inside the operator's area on the left console.



Failure to obey warning signs and instructions can cause serious injury or death. Never use excavator without instructions. Read and understand the Operation & Maintenance Manual and Handbook.

Keep away from dropoffs, steep areas or banks that could break away.

Explosion or electrocution can occur if machine contacts utility lines or pipes. Check for overhead or underground lines before operating.

Keep bystanders away. No riders. Check location of blade for direction of travel before moving steering controls.

Failure to operate machine from the operator's position can cause serious injury or death.

To Leave Excavator:

1. Lower attachment and blade to ground.
2. Stop engine and remove the key (if equipped).
3. Raise control console.

W-2518-0110



MACHINE SIGNS (DECALS) (CONT'D)

Pictorial Only Safety Signs (Cont'd)

8. Lift Capacity (7255508, 7255509)

This safety sign is located on the right window (cab models) or on the rear crossmember (canopy models).

A		B		B		B		B	
2000 mm (78 7/8)		2000 mm (78 7/8)		2000 mm (78 7/8)		2000 mm (78 7/8)		2000 mm (78 7/8)	
1100 mm (43 3/8)	*445 kg (980 lb)	*262 kg (577 lb)	230 kg (507 lb)	*440 kg (970 lb)	240 kg (529 lb)	*440 kg (970 lb)	230 kg (507 lb)	*440 kg (970 lb)	230 kg (507 lb)
1200 mm (47 1/4)	*373 kg (823 lb)	320 kg (705 lb)	270 kg (595 lb)	*400 kg (882 lb)	320 kg (705 lb)	*400 kg (882 lb)	270 kg (595 lb)	*400 kg (882 lb)	270 kg (595 lb)
1300 mm (51 1/8)	*300 kg (660 lb)	250 kg (551 lb)	210 kg (463 lb)	*320 kg (705 lb)	250 kg (551 lb)	*320 kg (705 lb)	210 kg (463 lb)	*320 kg (705 lb)	210 kg (463 lb)
1400 mm (55 1/8)	*230 kg (507 lb)	180 kg (397 lb)	150 kg (331 lb)	*250 kg (551 lb)	180 kg (397 lb)	*250 kg (551 lb)	150 kg (331 lb)	*250 kg (551 lb)	150 kg (331 lb)
1500 mm (59 1/8)	*160 kg (353 lb)	120 kg (265 lb)	100 kg (220 lb)	*180 kg (397 lb)	120 kg (265 lb)	*180 kg (397 lb)	100 kg (220 lb)	*180 kg (397 lb)	100 kg (220 lb)



Overload can tip the excavator and cause serious injury or death.

- Do not lift or hold any load that exceeds these ratings at their specific load radii and height.
- Total rated load is shown. The weight of all lifting devices must be deducted to determine the net load that can be lifted.

Read and understand the Operation & Maintenance Manual for more information.

W-2519-0110

9. Rotating Fan and Hot Surfaces (7243563)

This safety sign is located inside the engine compartment.



Rotating fan blade can cause serious injury or death. Keep away from fan and moving parts. Do not operate with guard removed.

Hot surfaces can cause injury. Do not touch. Allow to cool before servicing.

W-2521-0106

MACHINE SIGNS (DECALS) (CONT'D)

Pictorial Only Safety Signs (Cont'd)

10. Hot Surfaces (7185935)

This safety sign is located in the right cover on the radiator.



AVOID BURNS

Do not remove radiator cap when the engine is hot. You can be seriously burned.

W-2070-1203

11. Stay Away (7169009)

This safety sign is located on both upper rear corners of the upperstructure.



AVOID INJURY OR DEATH

- Keep out of swing area or travel path.
- Always look in the direction of travel.
- Make sure swing area is clear of bystanders and objects.

W-2775-1208

12. High Pressure, Battery, Rotating Fan, Exhaust Gases and Service Schedule (7252176)

This safety sign is located inside the tailgate.

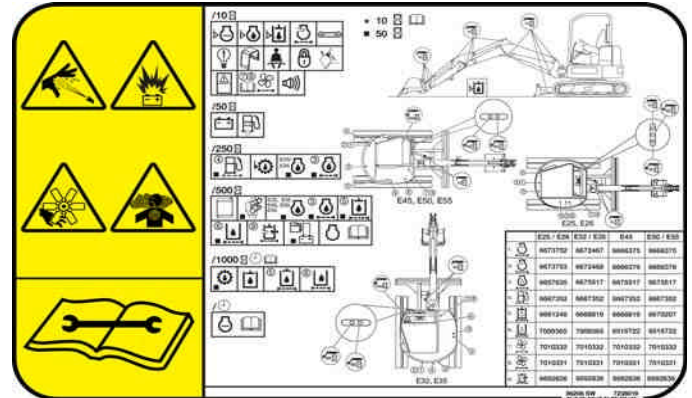

Leaking fluids under pressure can enter the skin and cause serious injury or death. Immediate medical attention is required. Wear goggles. Use cardboard to check for leaks.

Battery makes flammable and explosive gas. Keep arcs, sparks, flames and lighted tobacco away. Keep away from electrical contacts

Rotating fan can cause serious injury. Keep away from fan and moving parts. Do not operate with guard removed.

All exhaust gases can kill. Always ventilate.

Read and understand the Operation & Maintenance Manual for more information.

W-2522-0110



OPERATING INSTRUCTIONS

INSTRUMENTS AND CONSOLES	33
Cab Interior Light	33
Left Console	33
Right Console	34
Instrument Panel	35
Radio Option	38
Raising And Lowering The Console	40
OPERATOR CANOPY (ROPS / TOPS)	41
Description	41
OPERATOR CAB (ROPS / TOPS)	41
Description	41
Cab Door	42
Front Window	43
Front Wiper	44
Window Washer Reservoir	44
Right Side Window	45
Heating And Ventilation Ducting	46
EMERGENCY EXIT	47
Side Or Rear Window	47
Front Window	47
MOTION ALARM SYSTEM	48
Operation	48
TRAVEL CONTROLS	49
Forward And Reverse Travel	49
Turning	49
HYDRAULIC CONTROLS	51
ISO Control Pattern	51
Quick Couplers	52
Auxiliary Hydraulics - Joystick Controls	53
Relieve Hydraulic Pressure - With Joystick Controls (Excavator And Attachment)	54
Auxiliary Hydraulics - Manual Controls	54
Relieve Hydraulic Pressure - With Manual Controls (Excavator And Attachment)	54
ENGINE SPEED CONTROL	55
Setting Engine Speed (RPM)	55
BLADE CONTROL LEVER	55
Raising And Lowering Blade	55
TRACK FRAME RETRACTION - EXPANSION	56
Operation	56
Blade Expansion	57
BOOM SWING	58
Operation	58



BOOM LOAD HOLDING VALVE	59
Description	59
Lowering Boom With Load Holding Valve	59
ARM LOAD HOLDING VALVE	61
Description	61
Lowering Arm With Load Holding Valve	61
OVERLOAD WARNING DEVICE	63
Description	63
Operation	63
DAILY INSPECTION	64
Daily Inspection And Maintenance	64
PRE-STARTING PROCEDURE	65
Operation & Maintenance Manual And Operator's Handbook Locations	65
Entering The Excavator	65
Seat Adjustment	66
Seat Belt	66
Control Console	67
Mirror Adjustment	67
STARTING THE ENGINE	68
Key Switch	68
Keyless	69
Warming The Hydraulic System	70
Cold Temperature Starting	70
MONITORING THE DISPLAY PANELS	71
Instrument Panel	71
Warning And Shutdown	71
STOPPING THE ENGINE AND LEAVING THE EXCAVATOR	72
Procedure	72
ATTACHMENTS	73
Installing And Removing The Attachment (Pin-On Attachment)	73
Bobcat Quick Coupler (BQC) Type SW	74
Installing And Removing The Attachment (Bobcat Quick Coupler (BQC) Type K)	77
Quick Coupler And Attachment Inspection	81



OPERATING PROCEDURE	82
Inspect The Work Area	82
Basic Operating Instructions	82
Lowering The Work Equipment (Engine STOPPED)	82
Object Handling	83
Lift Capacity	84
Using The Clamp	86
Excavating	87
Boom Swing	89
Backfilling	90
Driving The Excavator	90
Operating On Slopes	91
Operating In Water	93
Avoiding Track Damage	94
 TOWING THE EXCAVATOR	 95
Procedure	95
 LIFTING THE EXCAVATOR	 96
Procedure	96
 TRANSPORTING THE EXCAVATOR ON A TRAILER	 97
Loading And Unloading	97
Fastening	97



Bobcat®

INSTRUMENTS AND CONSOLES

Cab Interior Light

Interior light is equipped on excavators with a cab.

Figure 7

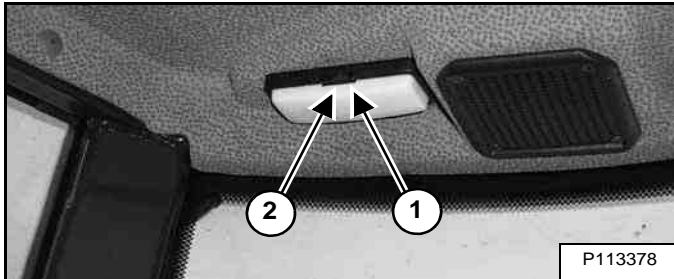

Press the switch to the right (Item 1) to turn the light ON. Press the switch to the left (Item 2) [Figure 7] to turn the light OFF.

Left Console

Figure 8

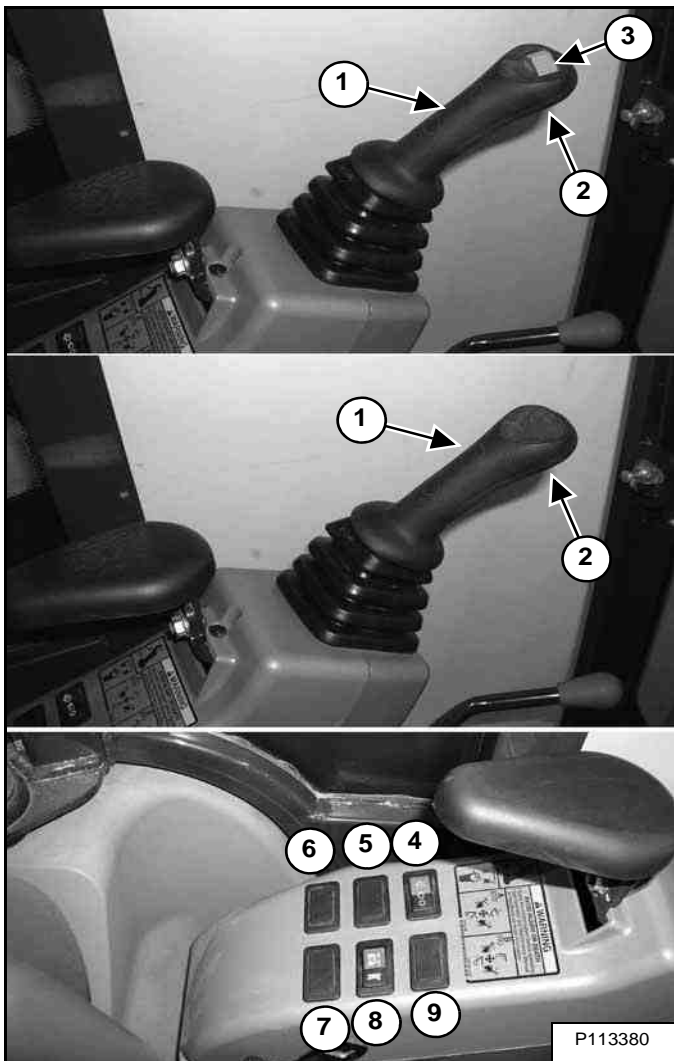

Left Console [Figure 8]

REF. NO	DESCRIPTION	FUNCTION / OPERATION
1	Left Joystick	(See HYDRAULIC CONTROLS on Page 51.)
2	Horn	Press the switch on the left joystick to sound horn.
3	Boom Swing Switch (If Equipped)	Move the switch to the left to swing the boom to the left. Move the switch to the right to swing the boom to the right. NOTE: For machine not equipped with switch (Item 3) in the left joystick, (See BOOM SWING on Page 58.)
4	Wiper / Washer Switch (If Equipped)	Press the switch to the left to turn wiper ON. Press and hold switch to the left to activate window washer. Press the switch to the right to turn wiper OFF.
5	Not Used	- - -
6	Beacon / Strobe Light (If Equipped)	Press switch to the left to turn ON the beacon / Strobe light. Press the switch to the right to turn OFF.
7	Overload Warning Device Switch (If Equipped)	Press the switch to the left to turn the overload warning device ON. Press to the right to turn OFF. (See OVERLOAD WARNING DEVICE on Page 63.)
8	Blade / Track Retraction - Expansion Switch	Press the switch to the left to expand / retract the tracks. Press the switch to the right to raise and lower the boom. (See TRACK EXPANSION in this manual.)
9	Not Used	- - -

INSTRUMENTS AND CONSOLES (CONT'D)

Right Console

Figure 9

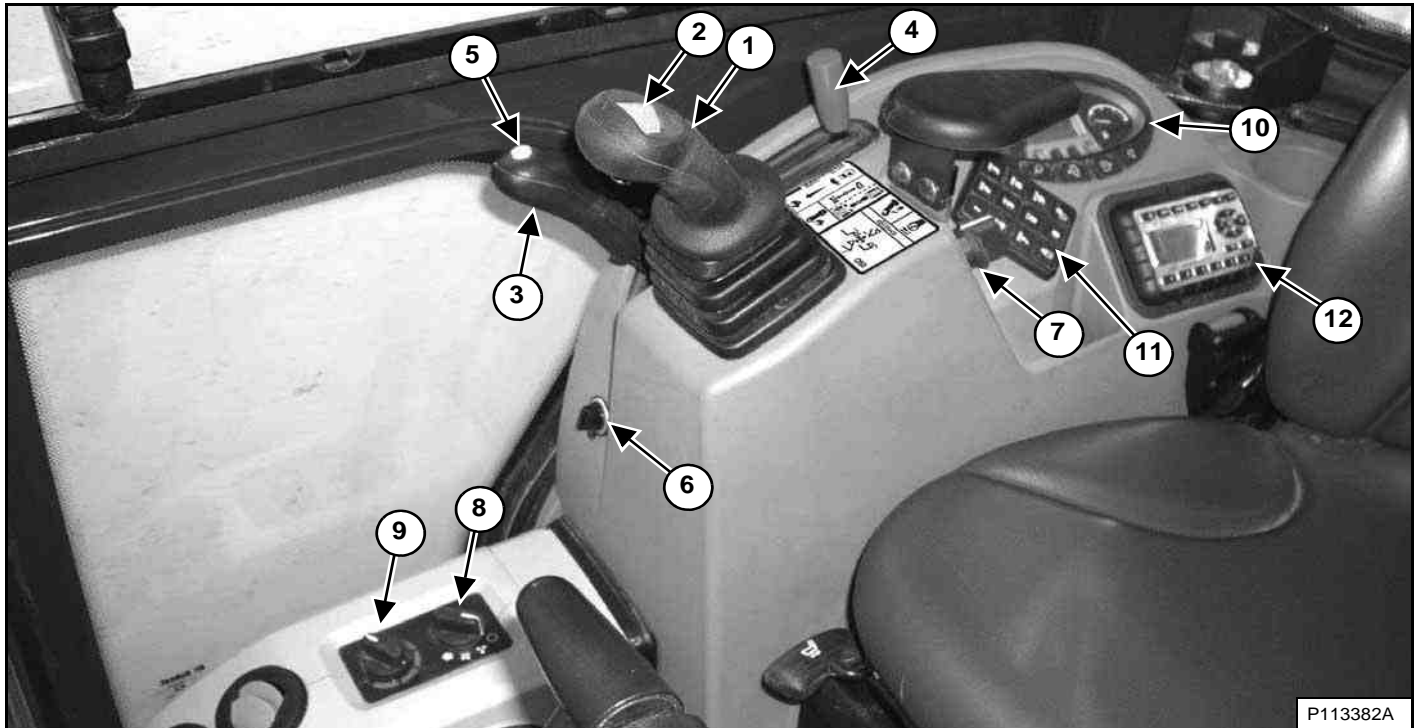

REF	DESCRIPTION	FUNCTION / OPERATION
1	Right Joystick	(See HYDRAULIC CONTROLS in this manual.)
2	Auxiliary Hydraulic Switch (If Equipped)	Controls the fluid flow to the auxiliary quick couplers (attachment). (See Auxiliary Hydraulics - Joystick Controls on Page 53.) NOTE: For machine not equipped with switch (Item 2) in the right joystick, see Auxiliary Hydraulic Pedal information. (See Auxiliary Hydraulics - Manual Controls on Page 54.)
3	Blade Control Lever / Track Retraction - Expansion Lever	Controls raising and lowering the blade. (See BLADE CONTROL LEVER on Page 55.) Controls extending and retracting the tracks. (See TRACK FRAME RETRACTION - EXPANSION on Page 56.)
4	Engine Speed Control Lever	Controls rpm of the engine. (See ENGINE SPEED CONTROL LEVER in this manual).
5	Two-Speed Button	Not Available On This Model
6	Auxiliary Power Outlet	12 volt receptacle for accessories.
7	Key Switch / Rotary Start Switch	Always perform the <i>PRE-STARTING PROCEDURE</i> . (See <i>PRE-STARTING PROCEDURE</i> in this manual), before starting the engine. (See <i>STARTING THE ENGINE</i> in this manual).
8	Fan Motor Switch (If Equipped)	Turn clockwise to increase fan speed; anticlockwise to decrease.
9	Temperature Control (If Equipped)	Turn clockwise to increase temperature; anticlockwise to decrease.
10	Instrument Panel	See Standard or Deluxe Instrument Panel
11	Keyless (If Equipped)	(Always perform the <i>PRE-STARTING PROCEDURE</i> , (See <i>PRE-STARTING PROCEDURE</i> in this manual), before starting the engine. (See <i>STARTING THE ENGINE</i> in this manual).
12	Radio (If Equipped)	(See <i>RADIO</i> information in this manual).

NOTE: Always turn key switch and all accessories to OFF position when the engine is stopped, the battery will discharge if the key is left ON.



INSTRUMENTS AND CONSOLES (CONT'D)

Instrument Panel

Figure 10



P-97989

REF. NO.	DESCRIPTION	FUNCTION / OPERATION
1	Lights	Press once for work lights. (Left green LED illuminates.) Press again to turn all lights off. (Left green LED off.)
		Press and hold 5 seconds to display software version in display screen.
2	Auto Idle Feature (NOT USED FOR THIS MODEL)	----
3	Auxiliary Hydraulic Button (Used With Joystick Switch Activated Auxiliary Hydraulics Only)	Press once to enable auxiliary hydraulic function. (Left green LED illuminates.) See Auxiliary Hydraulics in this manual. (See Auxiliary Hydraulics - Joystick Controls on Page 53.) or (See Auxiliary Hydraulics - Manual Controls on Page 54.)
4	Information	Cycles through (after each button press) (The following information is displayed in the Data Display Screen, Item 6): <ul style="list-style-type: none"> • Hourmeter (On startup) • Job Clock (1 and 2) • Engine rpm • Battery voltage • Maintenance clock (Press and hold 7 seconds when displayed to reset the maintenance clock.) • Service codes*
5	Engine Temperature Gauge	Shows the engine coolant temperature.



INSTRUMENTS AND CONSOLES (CONT'D)

Instrument Panel (Cont'd)

REF. NO.	DESCRIPTION	FUNCTION / OPERATION
6	Data Display Screen	The data display screen shows the Hourmeter at start up and then changes to engine rpm during normal operation of the excavator. When preheat is activated, the display screen will show the remaining preheat time. Can also be used to display Job Clock, Engine rpm, and Selectable Auxiliary Hydraulic Flow. (See Job Clock in this manual).
7	Fuel Gauge	Shows the amount of fuel in the tank.
8	Seat Belt	Fasten Seat Belt Reminder - Light stays on for 45 seconds to remind operator to fasten seat belt.
9		Not used for this model.
10		Not used for this model.
11	Left Console Lockout	Icon ON when left console is raised. Icon OFF when left console is lowered.
12	General Warning **	Malfunction with one or more machine functions. (See Service Codes in this manual.)
13	High Range Engaged ***	Not Available On This Model
14	Engine Coolant Temperature **	Engine coolant temperature high or sensor error.
15	Engine Malfunction **	Engine malfunction or failure.
16	Hydraulic System Malfunction **	Hydraulic system malfunction or failure.
17	Fuel	Fuel level low or sensor error. (Icon is ON when fuel level is low, Icon flashes when fuel sensor fault is activated.)
18		Not used for this model.
19		Not used for this model.
20		Not used for this model.
21		Not used for this model.

* See SYSTEM SETUP AND ANALYSIS for Service Code Description. (See DIAGNOSTIC SERVICE CODES on Page 147.)

** Icons will be ON or flashing when diagnostic system indicates a problem. (See DIAGNOSTIC SERVICE CODES on Page 147.)

*** Icons will be flashing when diagnostic system indicates a problem. (See DIAGNOSTIC SERVICE CODES on Page 147.)



INSTRUMENTS AND CONSOLES (CONT'D)

Instrument Panel - Standard (Cont'd)

Indicator Icons

The display screen can display the following information:

- Operating hours
- Job Clock (1 and 2)
- Engine rpm
- Battery voltage
- Maintenance clock countdown
- Service codes

Figure 11

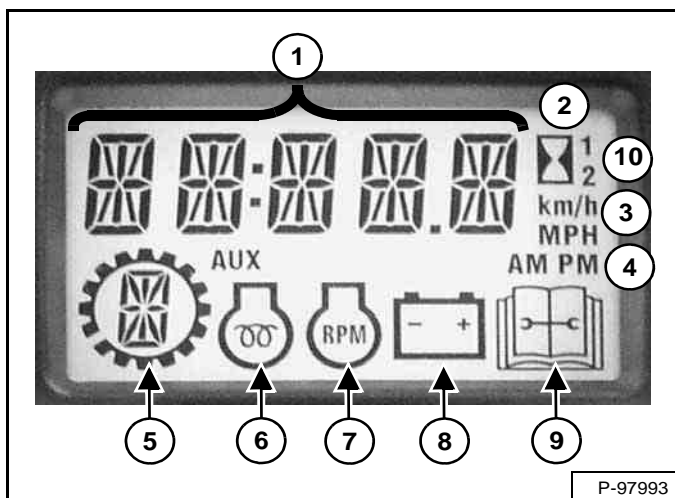

The display screen is shown in **[Figure 11]**. The data display will show operating hours upon startup.

1. **Data Display**
2. **Hourmeter**
3. **Metric / English (Not Used For This Model)**
4. **Clock (Not Used For This Model)**
5. **Selectable Auxiliary Flow**
6. **Engine Preheat**
7. **Engine RPM**
8. **Battery / Charging Voltage**
9. **Service**
10. **Job Clock (1 and 2)**

INSTRUMENTS AND CONTROLS (CONT'D)

Radio Option

Figure 12

This excavator may be equipped with a radio (Item 1) [Figure 12].

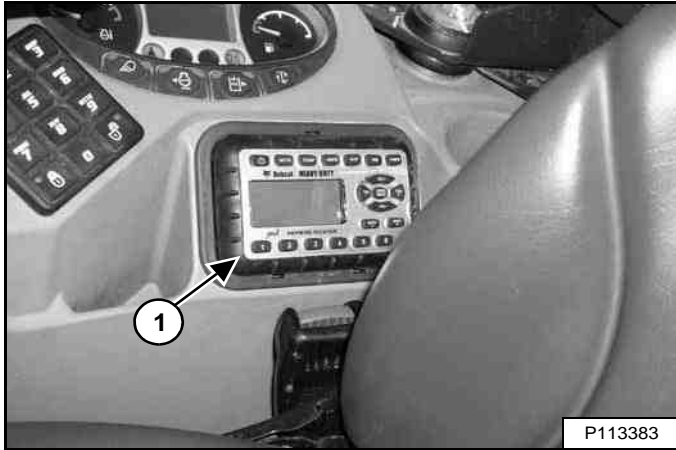
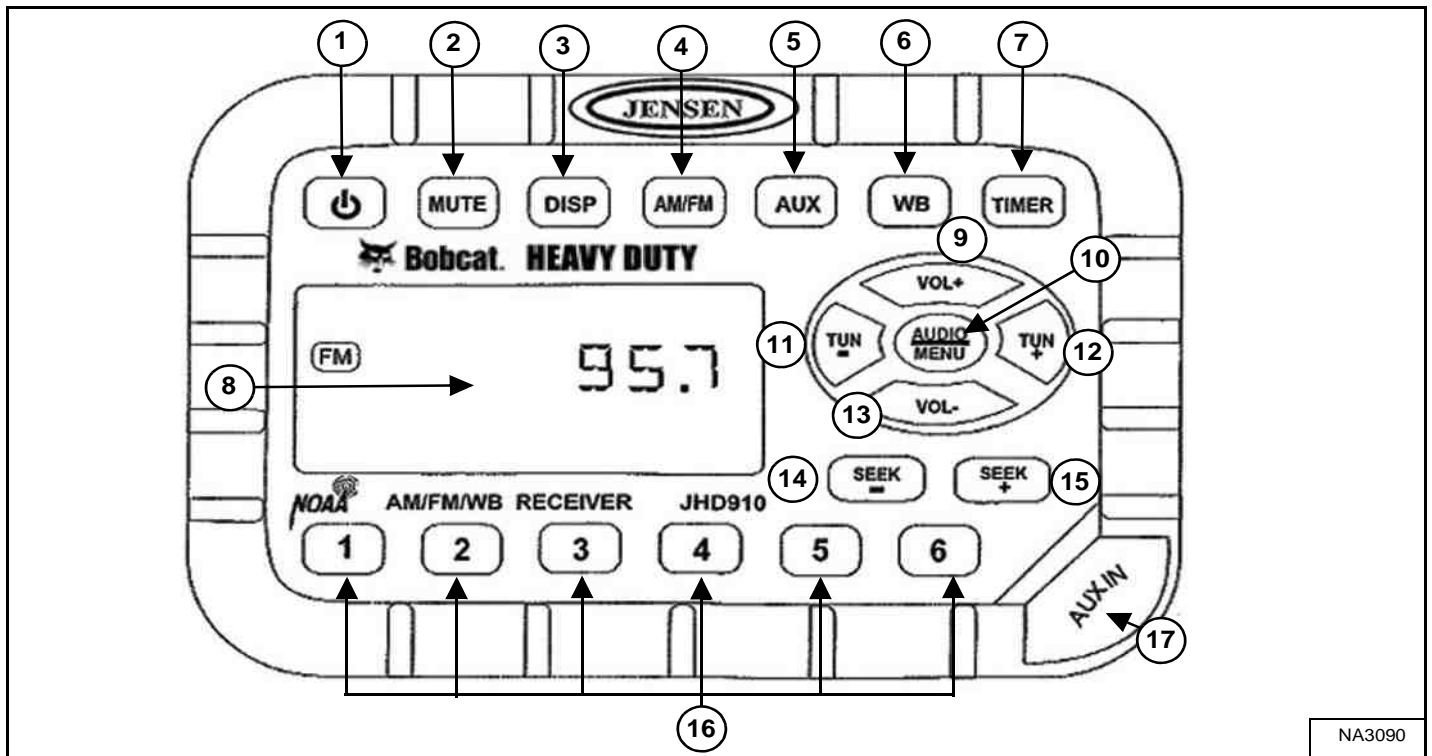

Figure 13



NOTE: See DISPLAY (Item 3) in the following table for clock setting instructions.



INSTRUMENT AND CONTROLS (CONT'D)

Radio (Cont'd)

REF. NO.	DESCRIPTION	FUNCTION / OPERATION
1	POWER	Press to turn ON; press again to turn OFF.
2	MUTE	Press to mute audio output; MUTE will appear in display screen; press again to turn OFF.
3	DISPLAY	Press to toggle between function mode (showing tuner frequency, auxiliary input, weather band information, or timer) and clock mode. Press and hold to enter clock setting mode; use FREQUENCY DOWN (TUN -) button to adjust hours and FREQUENCY UP (TUN +) button to adjust minutes; normal operation will resume automatically.
4	BAND	Press to select tuner mode. Press to cycle through 2 AM (MW) bands and 3 FM bands.
5	AUXILIARY	Press to select Auxiliary Input mode. Portable audio device (MP3 player) must be attached to auxiliary input jack.
6	WEATHER BAND	Press to select weather band; use FREQUENCY UP (TUN +) and FREQUENCY DOWN (TUN -) buttons to adjust to the clearest station. The weather alert feature, if activated, will automatically switch from the current function to the weather band if a weather warning is received. See AUDIO / MENU ADJUSTMENT in this table.
7	TIMER	Press to access timer mode. Press to start the timer function; press again to stop timer; press again to resume timer or press and hold to reset timer and exit from timer mode.
8	DISPLAY SCREEN	Displays the time, frequency, and activated functions.
9	VOLUME UP	Adjusts volume up; current volume (0 - 40) will appear briefly in display screen.
10	AUDIO / MENU ADJUSTMENT	AUDIO ADJUSTMENT: Press to cycle through bass, treble, and balance settings; use VOLUME UP (VOL +) and VOLUME DOWN (VOL -) buttons to adjust when desired option is displayed; normal operation will resume automatically. MENU ADJUSTMENT: Press and hold for 3 seconds to enter menu adjustment settings; press to cycle through the following settings; use VOLUME UP (VOL +) and VOLUME DOWN (VOL -) buttons to adjust when desired option is displayed; normal operation will resume automatically. <ul style="list-style-type: none"> • Beep Confirm (On or Off) - Determines if beep will sound with each button press. • Operation Region (USA or Europe) - Selects the appropriate region. • Clock Display (12 or 24) - Selects a 12-hour or 24-hour clock display. • Display Brightness (Low, Medium, or High) - Determines brightness level of display screen. • Backlight Colour (Amber or Green) - Determines backlight colour of display screen. • Power On Volume (0 - 40) - Selects default volume setting when radio is turned on. • WB Alert (On or Off) - Determines if weather band alert feature is activated.
11	FREQUENCY DOWN	Press to manually tune the radio frequency down.
12	FREQUENCY UP	Press to manually tune the radio frequency up.
13	VOLUME DOWN	Adjusts volume down; current volume (0 - 40) will appear briefly in display screen.
14	SEEK FREQUENCY DOWN	Press to automatically tune frequency down to next strong station.
15	SEEK FREQUENCY UP	Press to automatically tune frequency up to next strong station.
16	PRESET STATIONS	Used to store and recall stations for each AM and FM band. Press and hold to store current station; press button to recall station.
17	AUXILIARY INPUT JACK	Connect line output of portable audio device (MP3 player) to 3,5 mm (1/8 in) jack and press AUXILIARY button.

INSTRUMENTS AND CONTROLS (CONT'D)

Raising And Lowering The Console

Raise the console before exiting the cab.

Figure 14

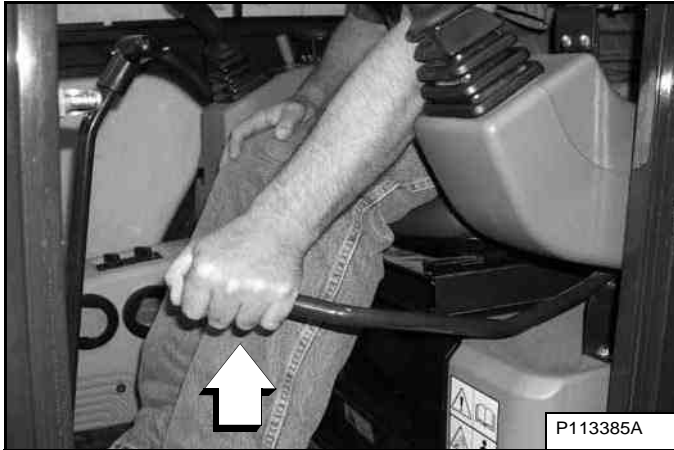

Pull up on the release handle [Figure 14]. The lift spring will assist in raising the console.

Lower the console before operating the excavator.

Push down on the console [Figure 14] until the latch is engaged.

NOTE: When the console is raised, the hydraulic and traction system functions are locked and will not operate.

If the engine stops, the boom / bucket (attachments) can be lowered to the ground using hydraulic pressure in the accumulator.

The control console must be in the locked down position, and the key switch in the ON position.



OPERATOR CANOPY (ROPS / TOPS)

Description

The Bobcat excavator has an operator canopy (ROPS / TOPS) as standard equipment to protect the operator if the excavator is tipped over. The seat belt must be worn for ROPS / TOPS protection.

Check the ROPS / TOPS canopy, mounting, and hardware for damage. Never modify the ROPS / TOPS canopy. Replace the canopy and hardware if damaged. See your Bobcat dealer for parts.

ROPS / TOPS - Roll-Over Protective Structure per ISO 12117-2, and Tip-Over Protective Structure per ISO 12117.



Never modify operator cab by welding, grinding, drilling holes or adding attachments unless instructed to do so by Bobcat Company. Changes to the cab can cause loss of operator protection from rollover and falling objects, and result in injury or death.

W-2069-0200

OPERATOR CAB (ROPS / TOPS)

Description

The Bobcat excavator has an optional operator cab (ROPS / TOPS) as standard equipment to protect the operator if the excavator is tipped over. The seat belt must be worn for ROPS / TOPS protection.

Check the ROPS / TOPS cab, mounting, and hardware for damage. Never modify the ROPS / TOPS cab. Replace the cab and hardware if damaged. See your Bobcat dealer for parts.

ROPS / TOPS - Roll-Over Protective Structure per ISO 12117-2, and Tip-Over Protective Structure per ISO 12117.



Never modify operator cab by welding, grinding, drilling holes or adding attachments unless instructed to do so by Bobcat Company. Changes to the cab can cause loss of operator protection from rollover and falling objects, and result in injury or death.

W-2069-0200

OPERATOR CAB (ROPS / TOPS) (CONT'D)

Cab Door

Figure 15

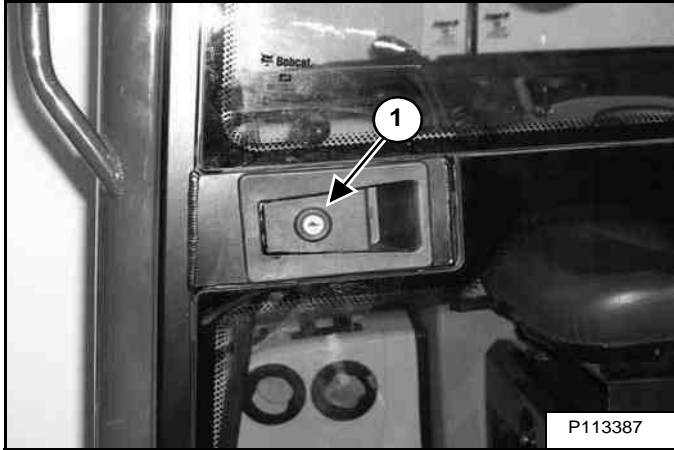

The cab door can be locked (Item 1) [Figure 15] with the same key as the starter switch. Pull on the latch to open the door.

Figure 16

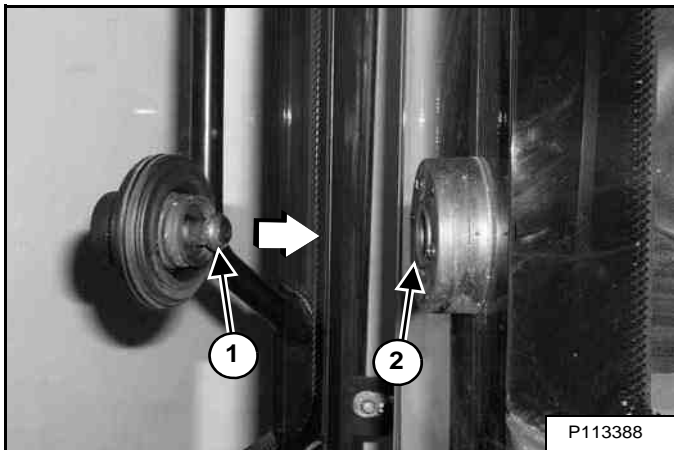

Push the door all the way open until the latch post (Item 1) engages in the latch (Item 2) [Figure 16] to hold the door in the open position.

Figure 17

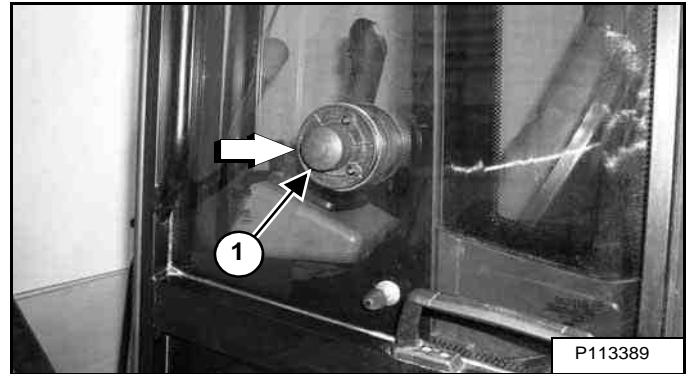

When the door is in the open position, push on the latch (Item 1) [Figure 17] and close the door.

Figure 18

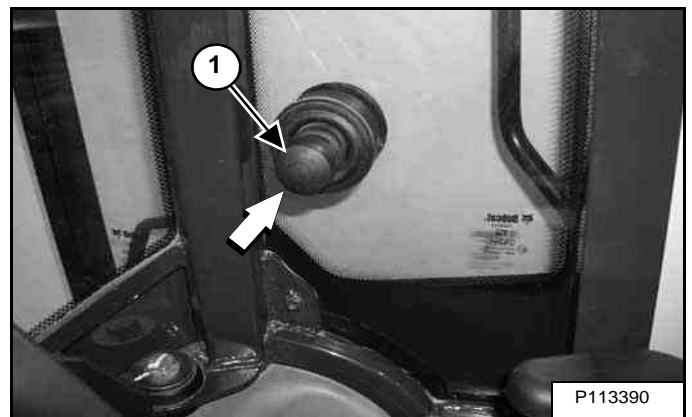

From inside the cab, push on the latch (Item 1) [Figure 18] and close the door.

Figure 19

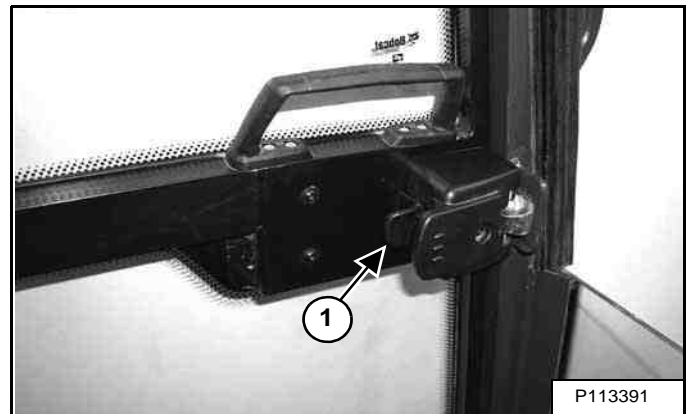

From inside the cab, to open the door, pull on the latch (Item 1) [Figure 19] and open the door.

OPERATOR CAB (ROPS / TOPS) (CONT'D)

Front Window

Opening The Front Window

Figure 20

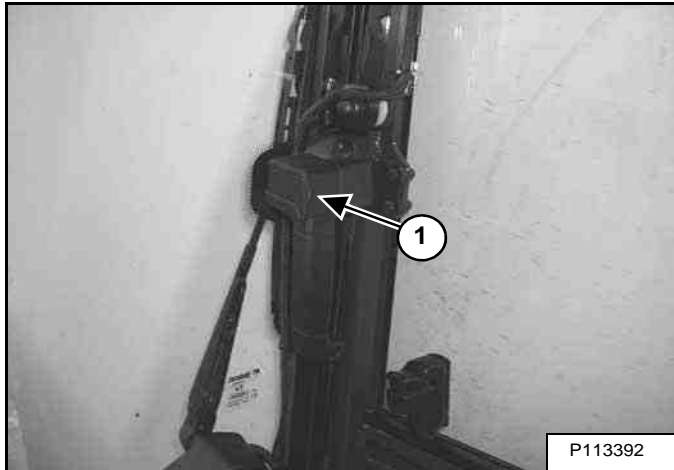

Press the window latch button (Item 1) **[Figure 20]** (both sides).

Figure 21

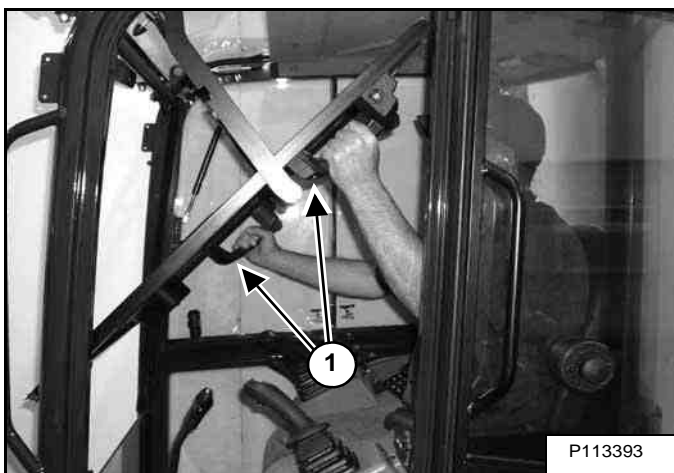

Use both window grab handles (Item 1) **[Figure 21]** to pull the top of the window in.

Continue moving the window in and up over the operator's head until the window is fully raised.

Figure 22

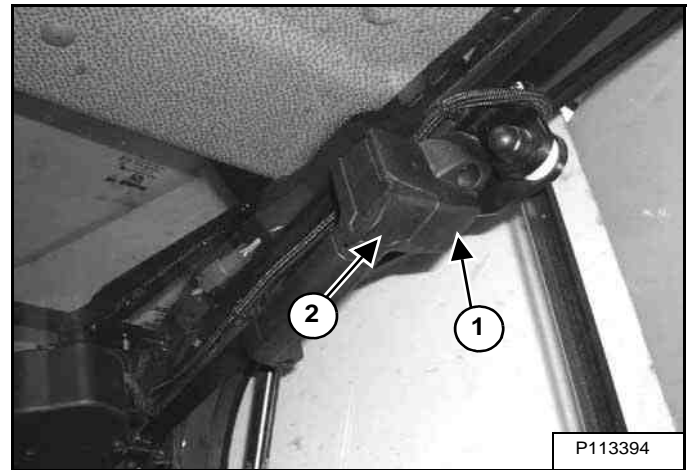

When the window is fully raised, the latch (Item 1) **[Figure 22]** (both sides) will close on the bracket in the latched position.

Pull down and forward slightly on the window to make sure it is fully latched.

Closing The Front Window

Use both window grab handles to support the window while pressing the window latch button (Item 2) **[Figure 22]** (both sides).

Use both window grab handles (Item 1) **[Figure 21]** to pull the window down fully.

Press the top of the window in until the latch locks into the latched position (both sides) **[Figure 20]**.

Pull inward and upward slightly on the window to make sure it is fully latched in the closed position.

OPERATOR CAB (ROPS / TOPS) (CONT'D)

Front Wiper

Figure 23

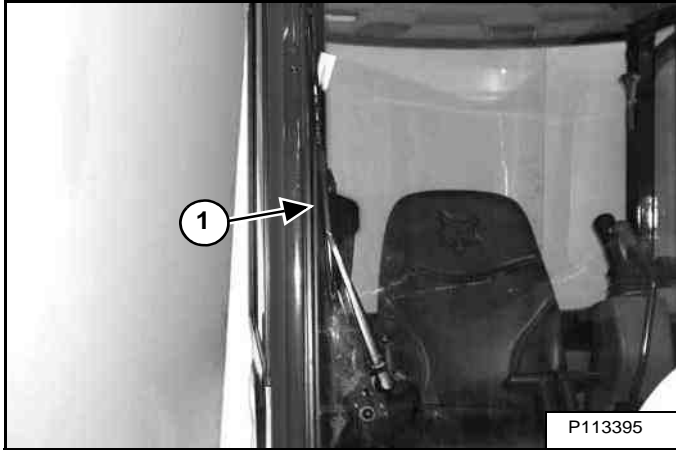

The front window is equipped with a wiper (Item 1) [Figure 23] and washer.

Window Washer Reservoir

Figure 24

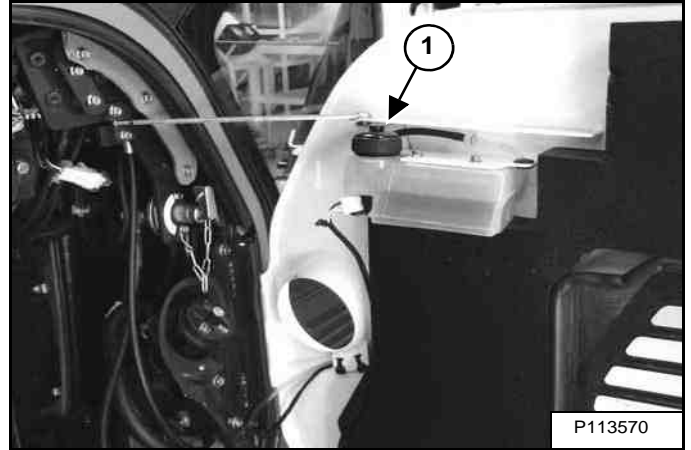

The window washer reservoir (Item 1) [Figure 24] is located on the right side cover.

NOTE: When temperatures are to reach below freezing, use a washer fluid that is recommended for use in cold temperatures to avoid damage to the washer reservoir.

OPERATOR CAB (ROPS / TOPS) (CONT'D)

Right Side Window

Opening The Right Front Window

Figure 25

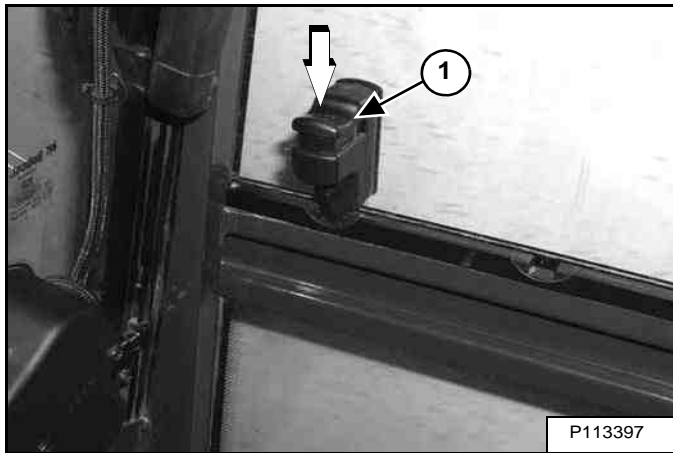

Press down on the latch (Item 1) [Figure 25] located at the front of the front window.

Figure 26

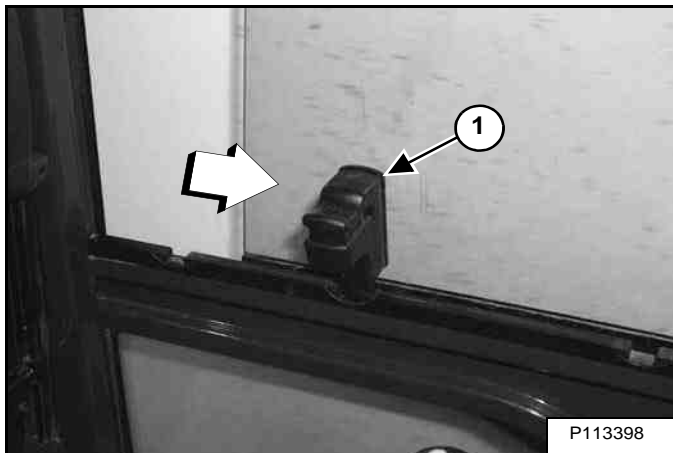

Pull the latch (Item 1) [Figure 26] backward to open the window until the desired stop. Release the latch and latch the window in place.

Closing The Right Front Window

Press down on the latch (Item 1) [Figure 25] and push the latch forward to close the window.

OPERATOR CAB (ROPS / TOPS) (CONT'D)

Heating And Ventilation Ducting

Figure 27

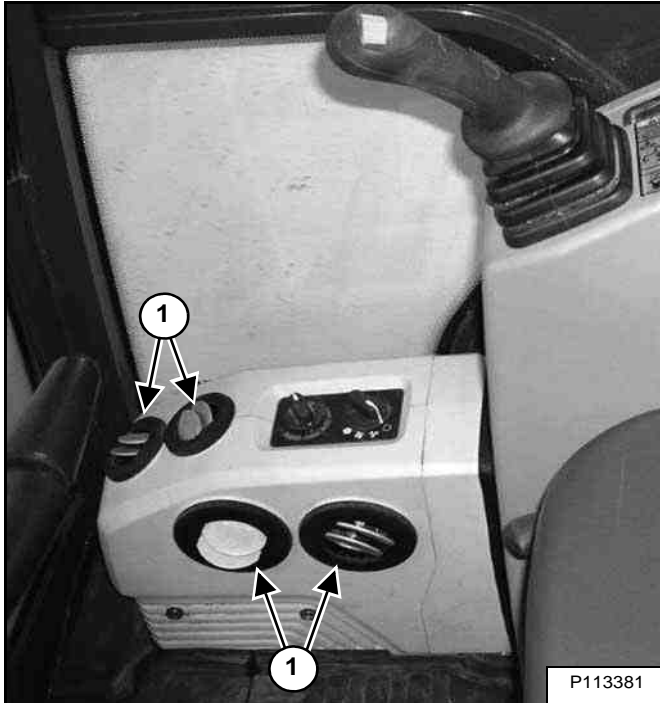

The heating and ventilation louvres (Item 1) [Figure 27] can be positioned as needed to direct the air flow to various areas in the cab.

EMERGENCY EXIT

The door, the rear window and the front window provide exits.

Side Or Rear Window

Figure 28

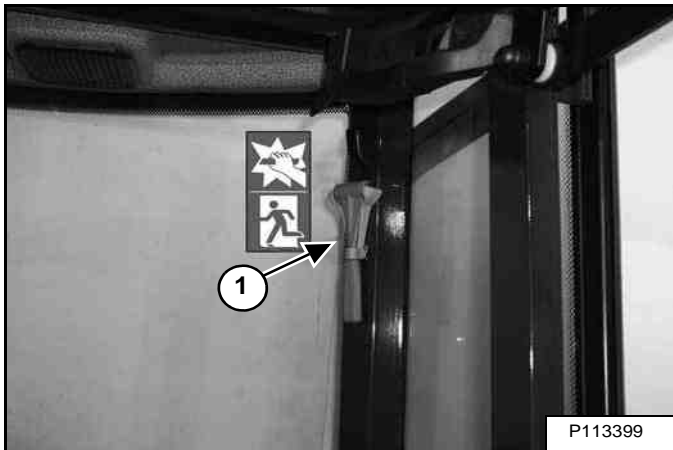

If emergency exit requires breaking a window, use the supplied hammer (Item 1) [Figure 28] located on the left rear side of the cab.

Figure 29

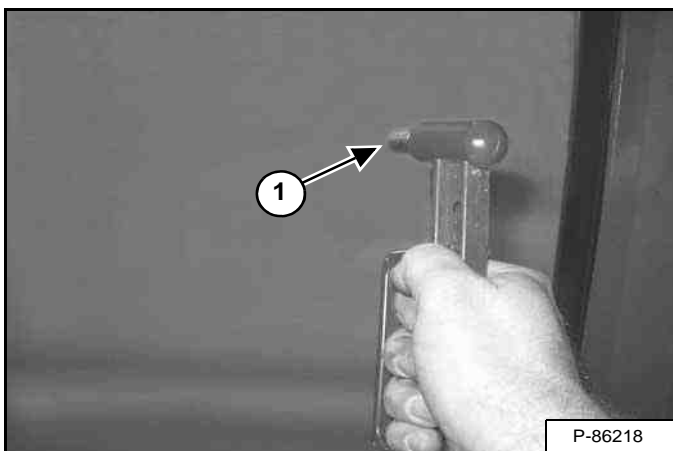

Remove the hammer from the storage position and strike the glass with the pointed end of the hammer [Figure 29].

Use the hammer to remove broken glass from the edge of the window before exiting.

Front Window

Figure 30



Open the front window and exit [Figure 30].

NOTE: If the excavator has a Special Applications Kit installed, the front window is NOT an emergency exit.

MOTION ALARM SYSTEM

Operation

Figure 31

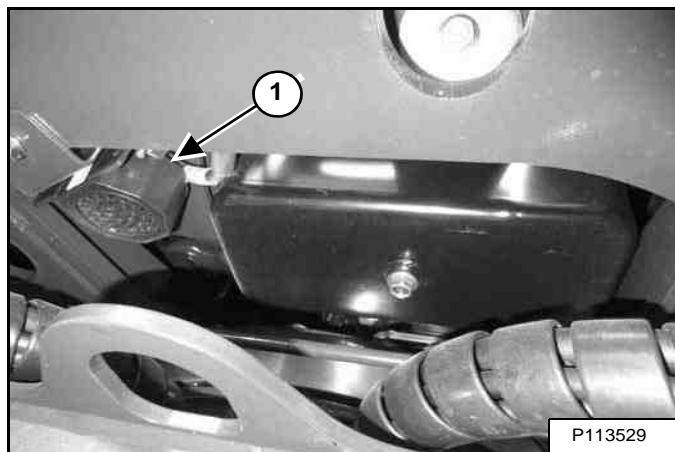

This excavator can be equipped with a motion alarm system. The motion alarm is located inside the rear (Item 1) [Figure 31] of the excavator.

WARNING

**This machine is equipped with a motion alarm.
ALARM MUST SOUND!
when operating forward or backward.**

Failure to maintain a clear view in the direction of travel could result in serious injury or death.

The operator is responsible for the safe operation of this machine.

W-2786-0309

The motion alarm will sound when the operator moves the travel control levers (Item 1) [Figure 32] in either the forward or reverse direction.

If alarm does not sound or for adjustment instructions, see inspection and maintenance instructions for the motion alarm system in the preventive maintenance section of this manual. (See MOTION ALARM SYSTEM on Page 107.)

TRAVEL CONTROLS

Forward And Reverse Travel

NOTE: The following procedures describe forward, reverse, left and right as seated in the operator's seat.

Figure 32

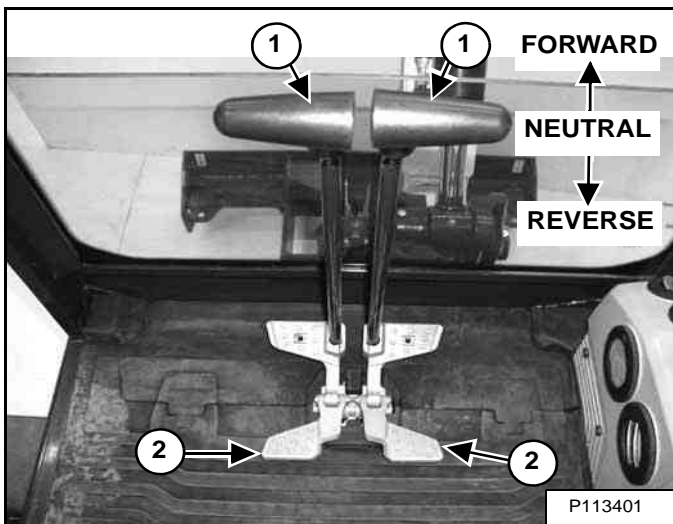

Put the blade so that it is at the front of the machine (as you sit in the operator's seat). Slowly move both steering levers* (Item 1) [Figure 32] forward for forward travel; backward for reverse travel.

* Travel can also be controlled with foot pedals (Item 2) [Figure 32]. Pivot the heel of the pedals forward for additional space on the floor.

WARNING

AVOID INJURY OR DEATH

- Check the blade location before travelling. When the blade is to the rear, operate the steering levers / foot pedals in the opposite direction to when the blade is in the front.
- Move the steering levers / foot pedals slowly. Abrupt lever motion will cause the machine to jerk.

W-2235-EN-1009

Turning

Right Turn

Figure 33

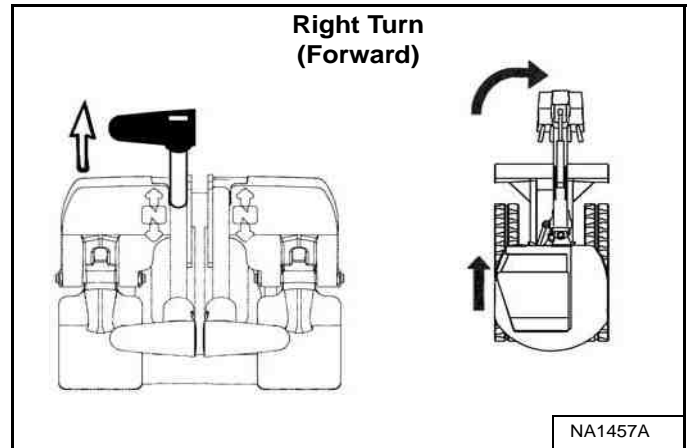

Push the left steering lever forward to turn right [Figure 33] while travelling forward.

Figure 34

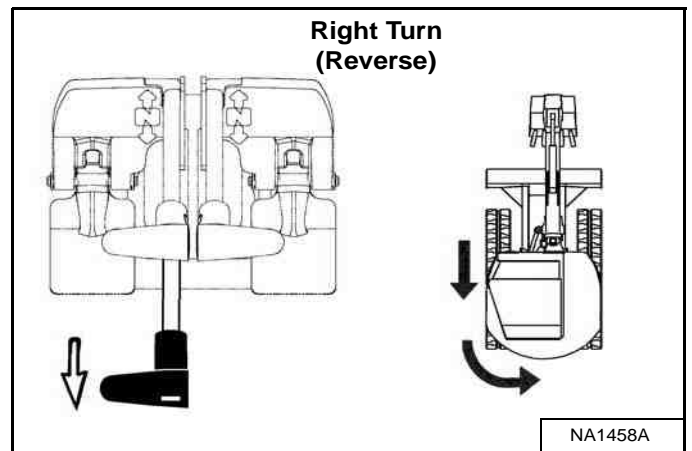

Pull the left steering lever backward to turn right while travelling backward [Figure 34].

TRAVEL CONTROLS (CONT'D)

Turning (Cont'd)

Counter-Rotation Right Turn

Figure 35

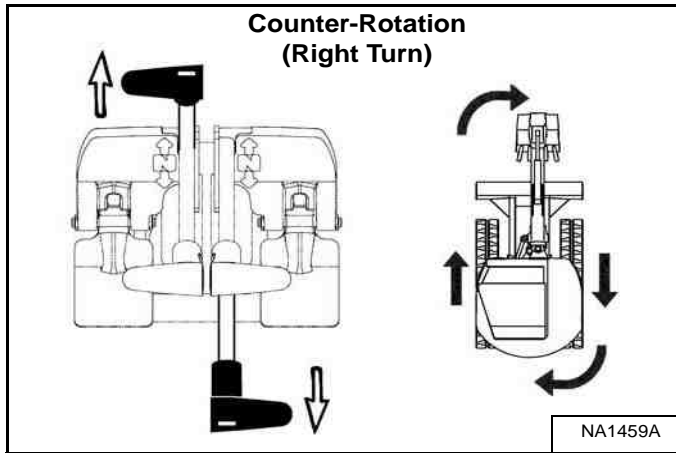

Push the left steering lever forward and pull the right steering lever backward **[Figure 35]**.

Left Turn

Figure 36

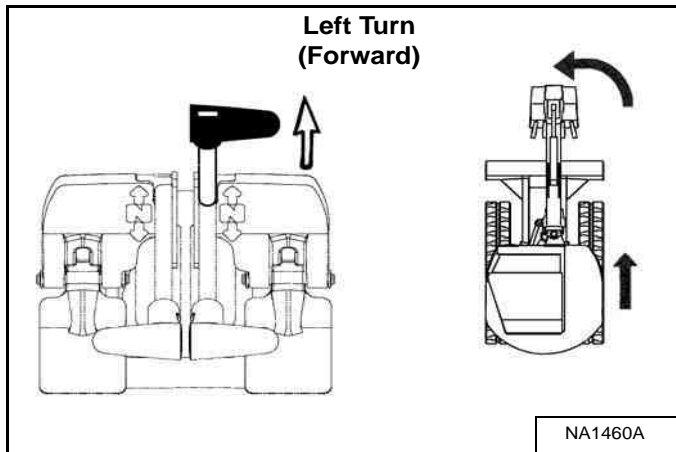

Push the right steering lever forward to turn left while travelling forward **[Figure 36]**.

Figure 37

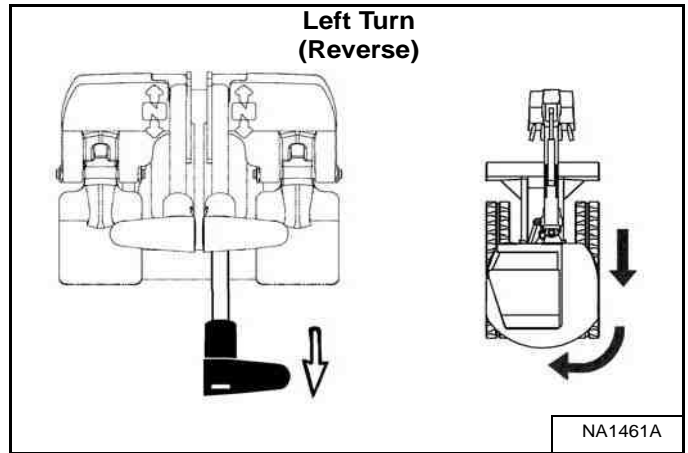

Pull the right steering lever backward to turn left while travelling backward **[Figure 37]**.

Counter-Rotation Left Turn

Figure 38

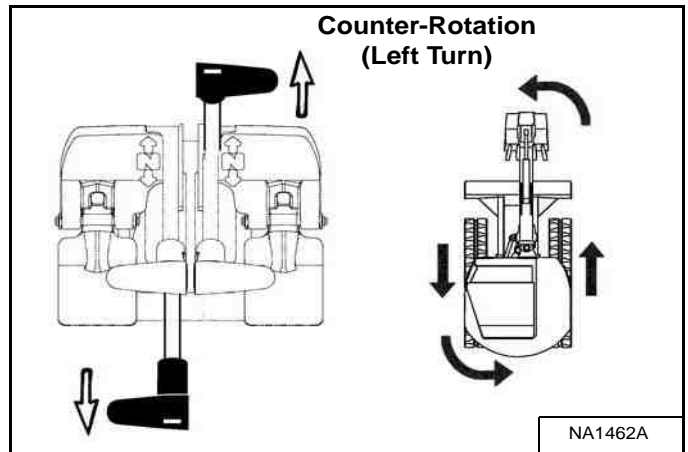

Push the right steering lever forward and pull the left steering lever backward **[Figure 38]**.

HYDRAULIC CONTROLS

ISO Control Pattern

Left Control Lever (Joystick)

Figure 39

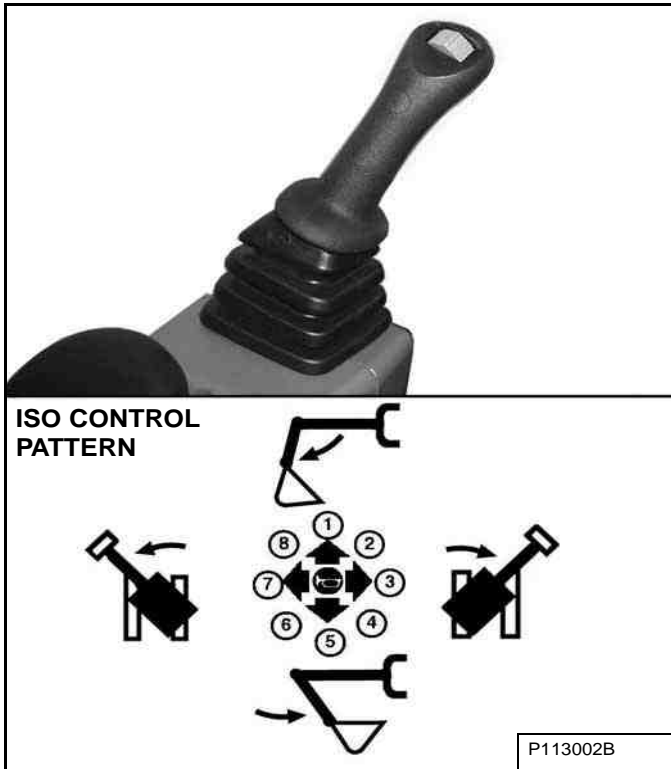

The left lever (joystick) is used to operate the arm and slew the upperstructure [Figure 39].

1. Arm out.
2. Arm out and slew right.
3. Slew right.
4. Arm in and slew right.
5. Arm in.
6. Arm in and slew left.
7. Slew left.
8. Arm out and slew left.

Right Control Lever (Joystick)

Figure 40

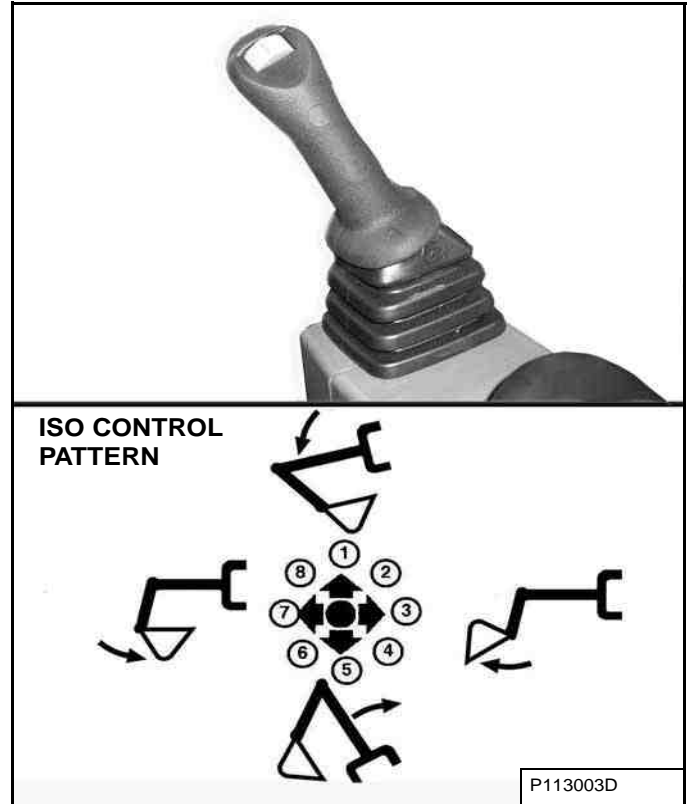

The right lever (joystick) is used to operate the boom and bucket [Figure 40].

1. Boom lower.
2. Boom lower and bucket dump.
3. Bucket dump.
4. Boom raise and bucket dump.
5. Boom raise.
6. Boom raise and bucket curl.
7. Bucket curl.
8. Boom lower and bucket curl.

WARNING

AVOID INJURY OR DEATH

Before leaving the machine:

- Lower the work equipment to the ground.
- Lower the blade to the ground.
- Stop the engine and remove the key.
- Raise the control console.

W-2780-0109

HYDRAULIC CONTROLS (CONT'D)

Quick Couplers

! WARNING

AVOID BURNS

Hydraulic fluid, tubes, fittings and quick couplers can get hot when running machine and attachments. Be careful when connecting and disconnecting quick couplers.

W-2220-0396

! WARNING

AVOID INJURY OR DEATH

Diesel fuel or hydraulic fluid under pressure can penetrate skin or eyes, causing serious injury or death. Fluid leaks under pressure may not be visible. Use a piece of cardboard or wood to find leaks. Do not use your bare hand. Wear safety goggles. If fluid enters skin or eyes, get immediate medical attention from a doctor familiar with this injury.

W-2072-EN-0909

Figure 41

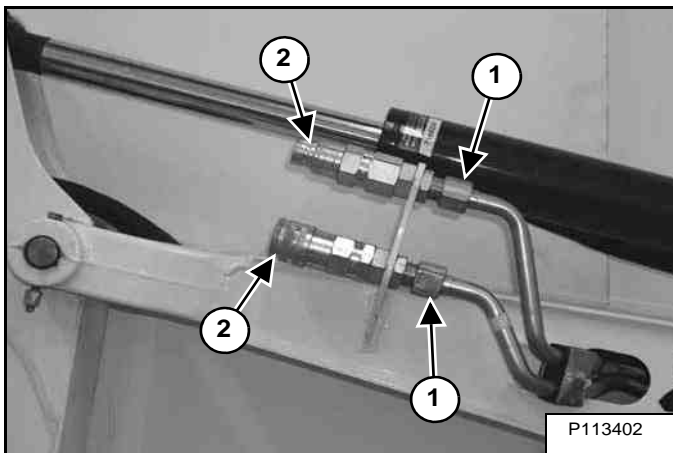

The excavator is supplied with hydraulic lines (Item 1) [Figure 41] that supply the hydraulic fluid for attachments.

Optional flush faced couplers (Item 2) [Figure 41] are available. See your Bobcat dealer for flush face couplers.

To Connect:

If equipped with flush face couplers, remove any dirt or debris from the surface of both the male and female couplers, and from the outside diameter of the male coupler. Visually check the couplers for corroding, cracking, damage, or excessive wear, if any of these conditions exist, the coupler(s) (Item 2) [Figure 41] must be replaced.

Install the male coupler into the female coupler. Full connection is made when the ball release sleeve slides forward on the female coupler.

To Disconnect:

Figure 42

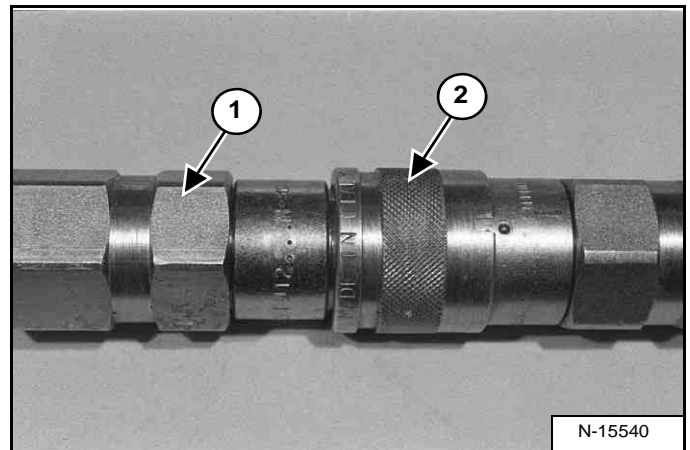

Hold the male coupler (Item 1). Retract the sleeve (Item 2) [Figure 42] on the female coupler until the couplers disconnect.



HYDRAULIC CONTROLS (CONT'D)

Auxiliary Hydraulics - Joystick Controls

If equipped with the auxiliary hydraulic switch (Item 1) [Figure 44] see the following information. If equipped with the auxiliary hydraulic pedal (Item 1) [Figure 46] (See Auxiliary Hydraulics - Manual Controls on Page 54.)

Continuous Hydraulic Flow

Press the button (Item 2) [Figure 44] on the front of the handle to provide continuous flow to the female coupler.

NOTE: Pressing the switch (Item 1) to the left while pressing the button (Item 2) [Figure 44] on the front of the handle will provide continuous flow to the male coupler.

Press the button (Item 2) [Figure 44] a second time to stop auxiliary flow to the quick couplers.

NOTE: Reverse flow can cause damage to some attachments. Use reverse flow with your attachment only if approved. See your attachment Operation & Maintenance Manual for detailed information.

Figure 43

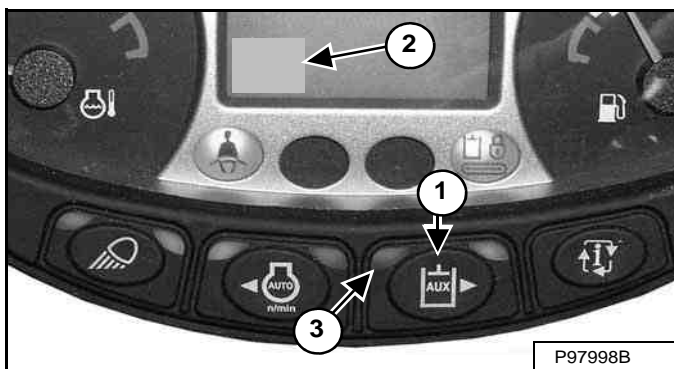

Selectable Auxiliary Hydraulics Flow

Press the auxiliary hydraulics button (Item 1) once to enable the selectable hydraulic flow. The light (Item 2) [Figure 43] will be illuminated when the selectable auxiliary hydraulics are enabled.

Press the button (Item 1) a second time to disable the auxiliary hydraulics. The light (Item 2) [Figure 43] will turn OFF.

NOTE: If the auxiliary hydraulics are enabled when the engine is turned OFF, they will stay enabled when the engine is restarted.

Press the Auxiliary Hydraulics button (Item 1) (an audible beep will sound each time the auxiliary button is pressed). The last selected auxiliary hydraulic flow (Aux3, Aux2 or Aux1) will appear in the data display (Item 2). The LED (Item 3) [Figure 43] will be illuminated.

To change the auxiliary flow, press the Auxiliary Hydraulics button (Item 1) to toggle through the settings, each time the button is pressed, the next setting will appear in the data display (Item 2) [Figure 43]. Once the desired setting is selected, it will stay at that setting until a different auxiliary flow is selected by the operator. (Example: Even if the engine was STOPPED, if Aux2 has been selected, after key OFF and engine restart, the Aux2 setting will still be the active hydraulic flow when the machine is started.)

Examples For Selecting Auxiliary Hydraulic Flow And The Attachments Used:

AUX FLOW SETTING	FLOW	ATTACHMENTS
Aux3	Maximum	Breaker, Auger
Aux2	Medium	Clamp
Aux1	Low	Attachments requiring very low flow for controllability

NOTE: Use only approved attachments for your model excavator. Attachments are approved for each model of excavator based on various factors. Using unapproved attachments could cause damage to the attachment or to the excavator.

Figure 44

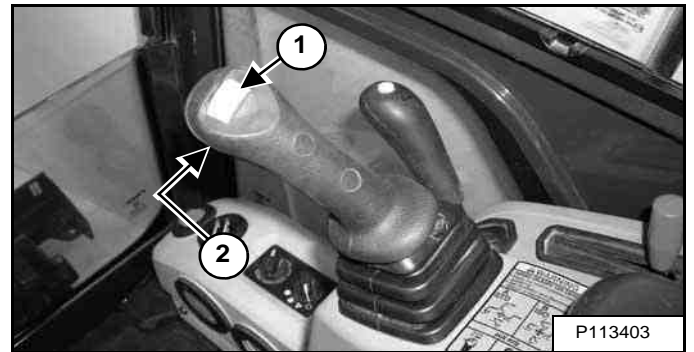

Move the switch (Item 1) [Figure 44] on the right control lever to the right to supply hydraulic flow to the female coupler. Move the switch to the left to supply hydraulic flow to the male coupler. If you move the switch halfway, the auxiliary functions move at approximately one-half speed.

Press the button (Item 2) [Figure 44] on the front of the handle to provide continuous selectable flow to the female coupler.

NOTE: Pressing the switch (Item 1) to the left while pressing the button (Item 2) [Figure 44] on the front of the handle will provide continuous selectable flow to the male coupler.

Press the button (Item 2) [Figure 44] a second time to stop auxiliary flow to the quick couplers.

HYDRAULIC CONTROLS (CONT'D)

Relieve Hydraulic Pressure - With Joystick Controls (Excavator And Attachment)

NOTE: The following is for auxiliary hydraulics with the joystick switch (Item 1) [Figure 44] only. For manual auxiliary hydraulic controls, see [Figure 46].

Excavator:

Put the attachment flat on the ground.

Stop the engine and turn the key switch to ON.

NOTE: The left console must be fully lowered for relieving hydraulic pressure.

NOTE: Excavator engine must have recently been started to relieve hydraulic pressure.

Figure 45

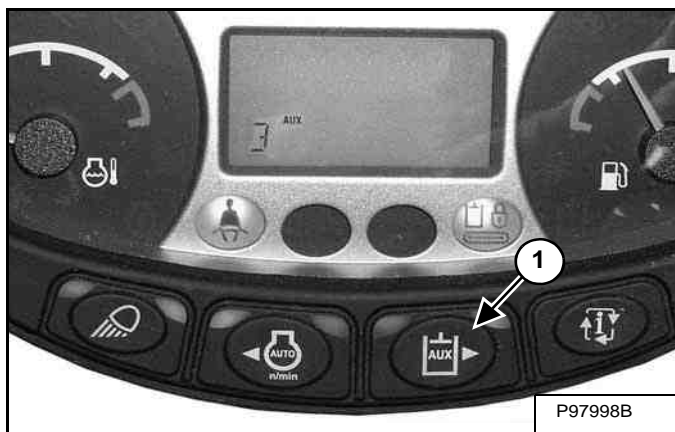

If the auxiliary hydraulics are disabled, press AUX HYD button (Item 1) [Figure 45] and then move the switch (Item 1) [Figure 44] to the right and left several times.

If the auxiliary hydraulics are enabled, then move the switch (Item 1) [Figure 44] to the right and left several times.

Attachments:

- Follow procedure above to relieve hydraulic pressure in excavator.
- Connect male coupler from attachment to female coupler of excavator then repeat procedure above. This will relieve pressure in the attachment.
- Connect the female coupler from the attachment.

Hydraulic pressure in the auxiliary hydraulic system can make it difficult to engage quick couplers to an attachment.

Auxiliary Hydraulics - Manual Controls

If equipped with the auxiliary hydraulic pedal (Item 1) [Figure 46] control, see the following information. If equipped with the joystick auxiliary hydraulic switch (Item 1) [Figure 44] (See Auxiliary Hydraulics - Joystick Controls on Page 53.)

Figure 46

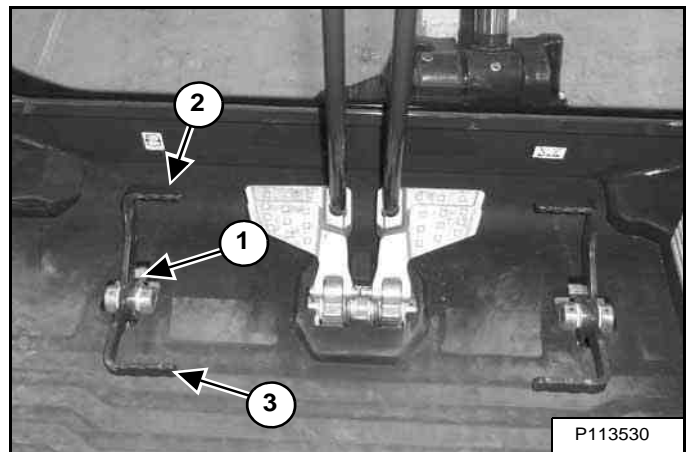

Press the toe of the pedal (Item 2) [Figure 46] to supply hydraulic flow to the female coupler (if equipped).

Press the heel of the pedal (Item 3) [Figure 46] to supply hydraulic flow to the male coupler (if equipped).

Relieve Hydraulic Pressure - With Manual Controls (Excavator And Attachment)

Put the attachment flat on the ground.

Stop the engine.

Excavator:

With the engine off, move the pedal (Item 1) [Figure 46] in both directions several times.

Attachments:

- Follow the procedure above to release pressure in the excavator.
- Connect the male coupler from attachment to the female coupler of the excavator. Then repeat procedure above. This will release pressure in the attachment.
- Connect the female coupler from the attachment.

Hydraulic pressure in the auxiliary hydraulic system can make it difficult to engage quick couplers to an attachment.

ENGINE SPEED CONTROL

Setting Engine Speed (RPM)

Figure 47

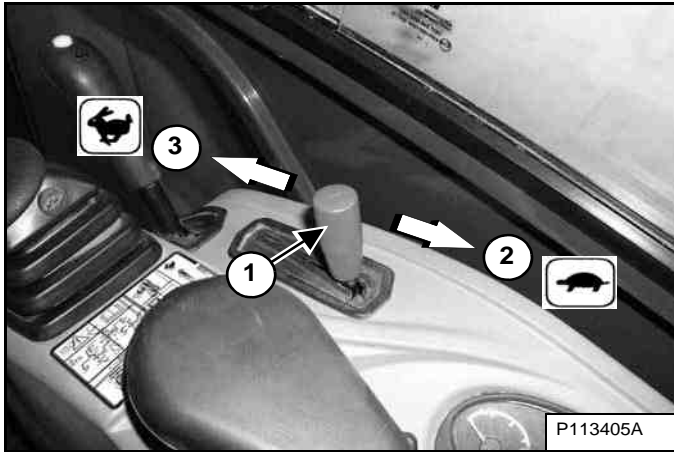

The engine speed control lever (Item 1) [Figure 47] controls engine rpm.

Move the engine speed control lever back (Item 2) to reduce engine rpm. Move the engine speed control dial forward (Item 3) [Figure 47] to increase engine rpm.

BLADE CONTROL LEVER

Raising And Lowering Blade

Figure 48

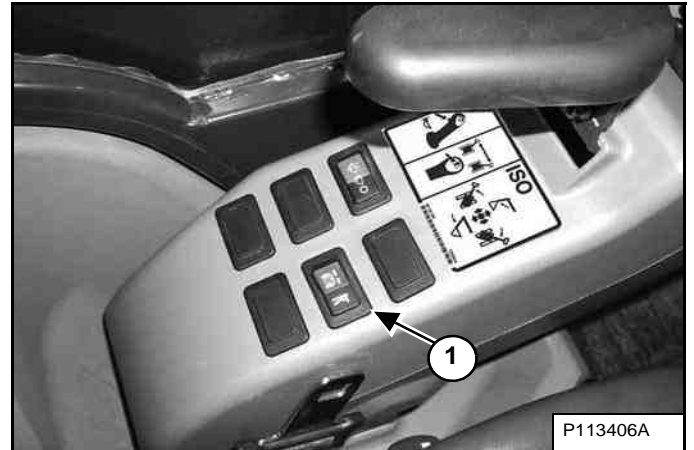

Push the Blade / Track Retraction - Expansion Switch (Item 1) [Figure 48] to the Blade position.

Figure 49

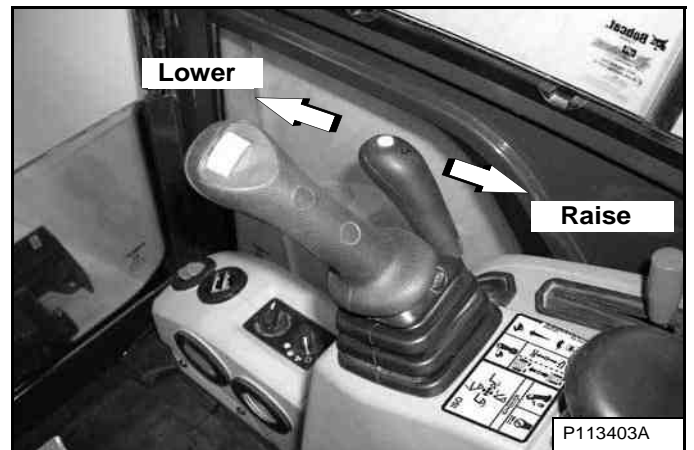

Move the Blade / Track Retraction - Expansion Lever forward to lower the blade [Figure 49].

Move the Blade / Track Retraction - Expansion Lever backward to raise the blade [Figure 49].

NOTE: Keep blade lowered for increased digging performance.

TRACK FRAME RETRACTION - EXPANSION

Operation

Figure 50

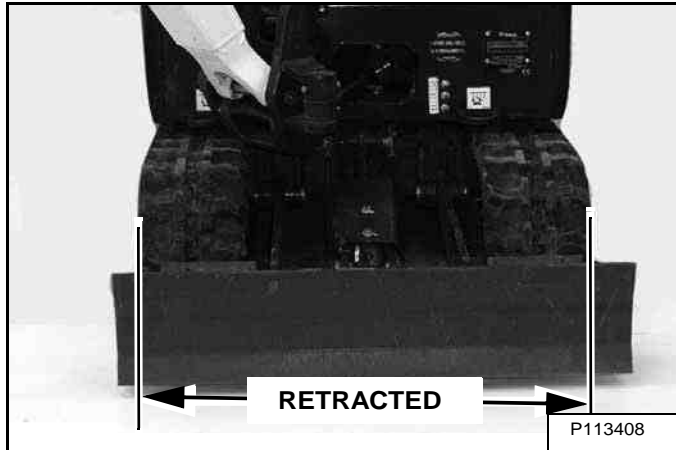

The excavator can be operated with the track frame retracted for transportation on a trailer or to access narrow areas [Figure 50].

Figure 51

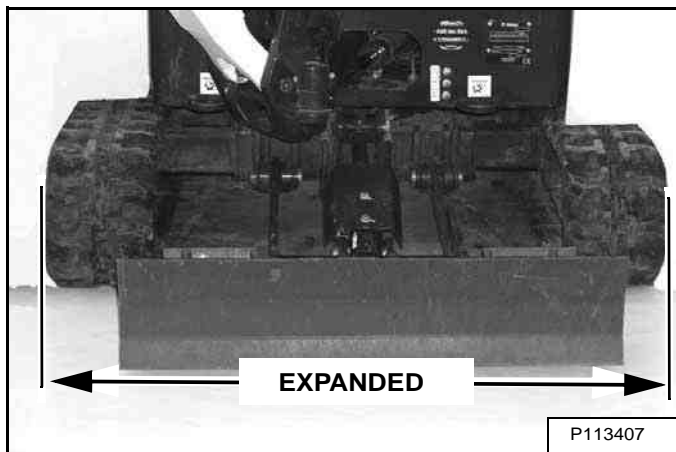

Expand the track frame for increased digging performance [Figure 51].

IMPORTANT

To prevent wear and damage to the track, always lift the excavator before expanding or retracting the track frame.

I-2193-0599

Figure 52

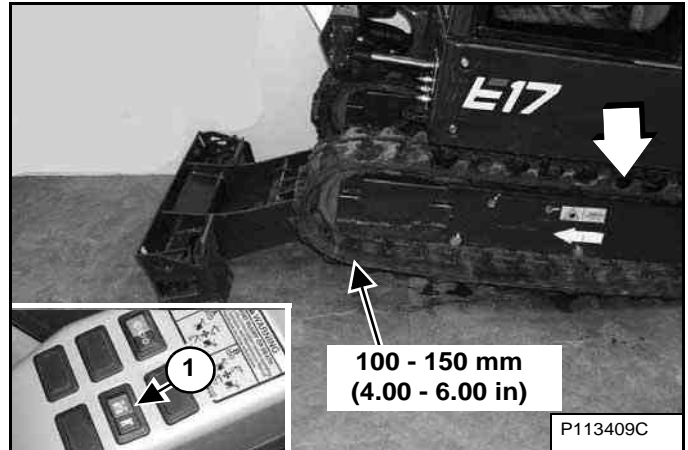

Put the Blade / Track Retraction - Expansion Switch (Item 1) [Figure 52] to the right in the Blade position.

With the boom and arm positioned over the blade, lower the blade until the track is raised 100 - 150 mm (4.00 - 6.00 in) off the ground [Figure 52].

Rotate the upperstructure 180 degrees.

Figure 53

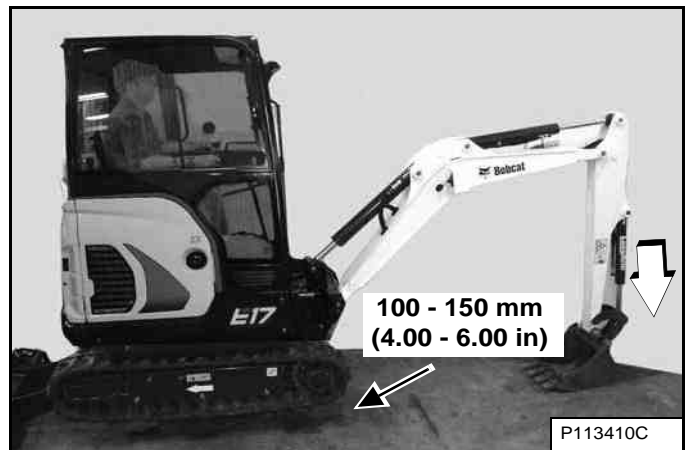

Lower the boom and arm to raise the rear of the excavator until the track is 100 - 150 mm (4.00 - 6.00 in) off the ground [Figure 53].

TRACK FRAME RETRACTION - EXPANSION (CONT'D)

Operation (Cont'd)

Figure 54



Push the Blade / Track Retraction - Expansion Switch (Item 1) [Figure 54] to the Track Retraction - Expansion position.

IMPORTANT

To prevent wear and damage to the track, always lift the excavator before expanding or retracting the track frame.

I-2193-0599

Figure 55



Push the Blade / Track Retraction - Expansion Lever (Item 1) [Figure 55] forward to expand the track frame. Hold the lever forward until the track frame is fully expanded.

Pull the Blade / Track Retraction - Expansion Lever [Figure 55] back to retract the track frame. Hold the lever back until the track frame is fully retracted.

The track frame must be either in the fully expanded or fully retracted position when in use.

Figure 56

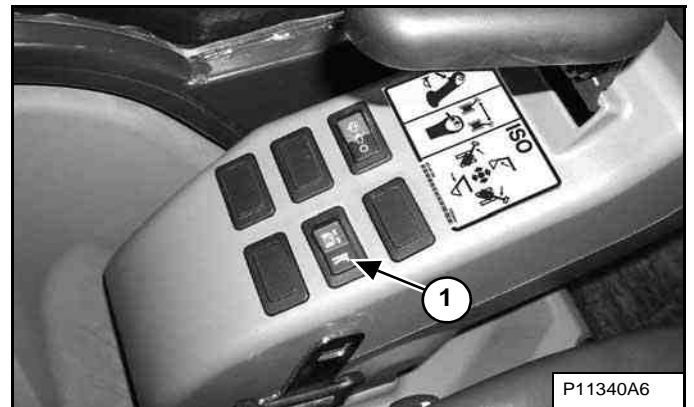

NOTE: Always return the Blade / Track Retraction - Expansion Switch (Item 1) [Figure 56] to the Blade position during operation so that the track does not move when using the Blade / Track Retraction - Expansion Lever.

Raise the boom and arm to lower the rear of the excavator to the ground.

Rotate the upperstructure 180 degrees.

Raise the blade until the tracks are on the ground.

Blade Expansion

Figure 57

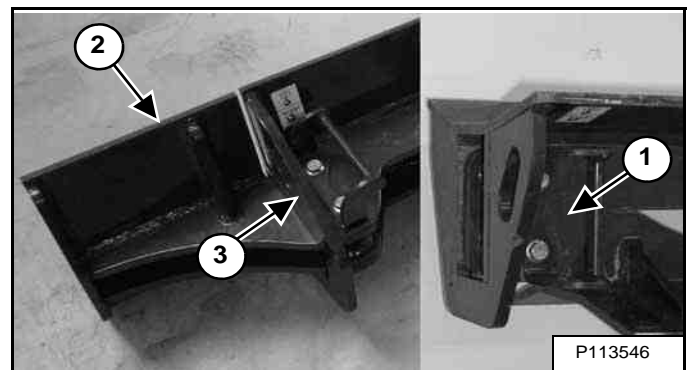

Raise the blade slightly and place a block under the blade. Lower the blade fully.

Remove the blade retainer pin assembly (Item 1) [Figure 57].

Remove and reposition the blade extension (Item 2) [Figure 57] to the outside blade position.

Reinstall the blade retainer pin assembly (Item 3) [Figure 57].

NOTE: Always operate the machine with the tracks fully expanded or fully retracted.

BOOM SWING

Operation

Figure 58

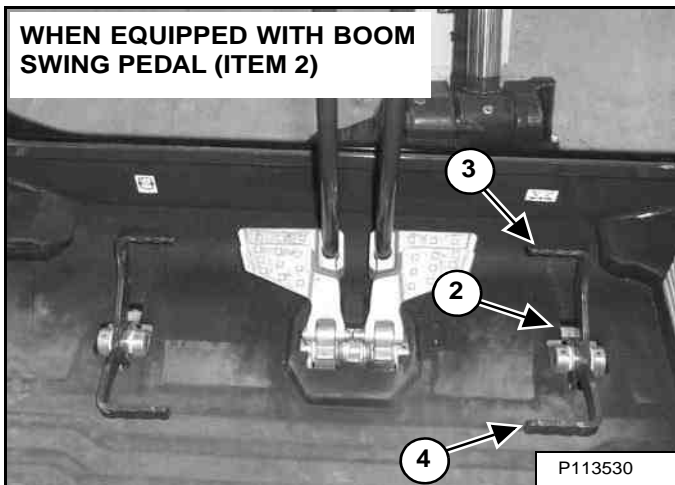
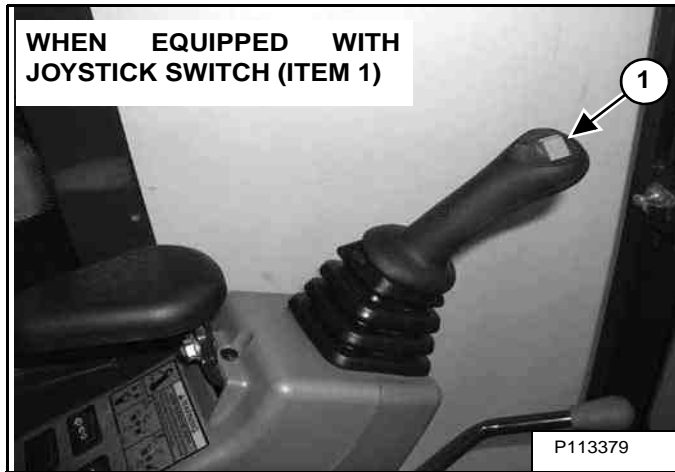

When equipped with Joystick Switch (Item 1) [Figure 58]:

The boom swing switch (Item 1) [Figure 58] (if equipped) on the left control lever (joystick) controls boom swing. Move the switch to the left to swing the boom to the left. Move the switch to the right to swing the boom to the right.

When equipped with Boom Swing Pedal (Item 2) [Figure 58]:

The boom swing pedal (Item 2) (if equipped) controls boom swing. Press the toe (Item 3) of the pedal to swing the boom to the left. Press the heel (Item 4) [Figure 58] of the pedal to swing the boom to the right.

Figure 59

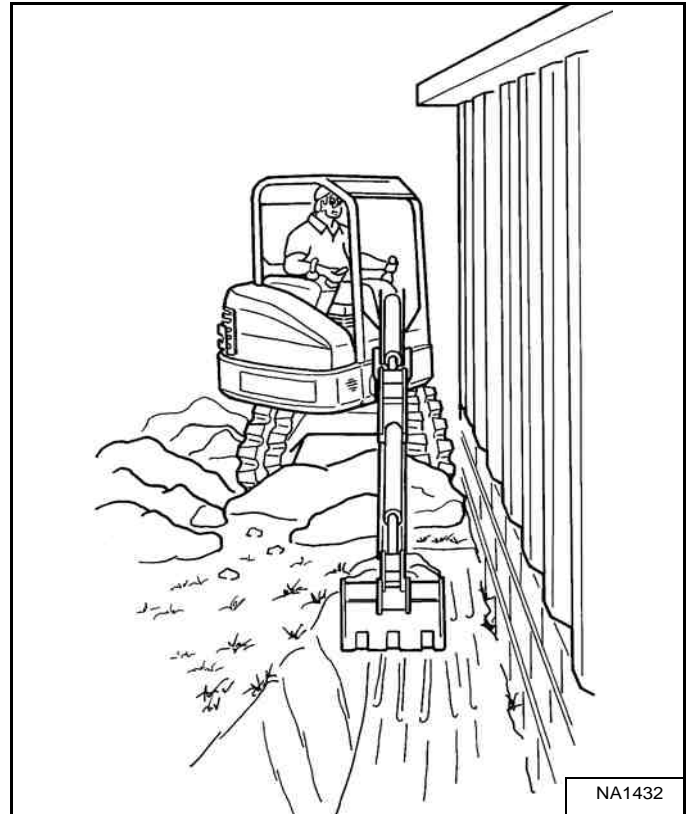

NOTE: The purpose of the boom swing is to offset the boom with respect to the upperstructure for digging close to a structure [Figure 59].

BOOM LOAD HOLDING VALVE

Description

The boom load holding valve (if equipped) will hold the boom in its current position in the event of hydraulic pressure loss.

! WARNING

AVOID INJURY OR DEATH

Do Not work or stand under raised work equipment or attachment.

W-2793-0409

Lowering Boom With Load Holding Valve

Figure 60

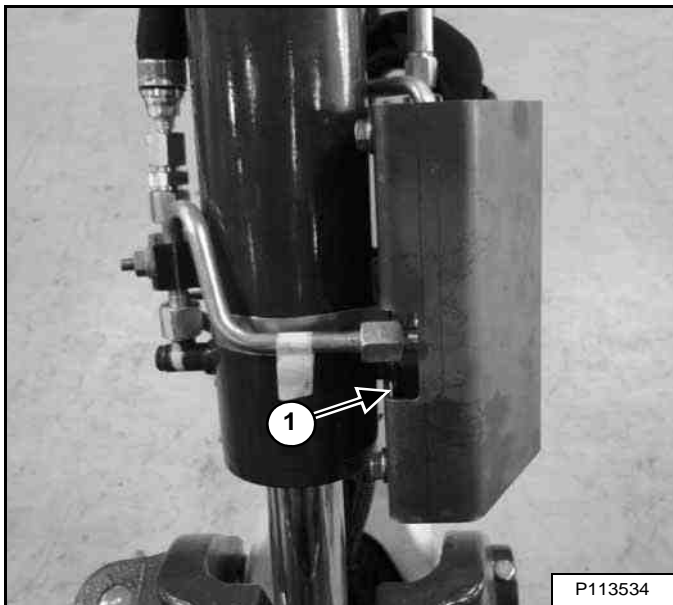

If the excavator is equipped with a boom load holding valve (Item 1) [Figure 60], it will be attached to the boom cylinder at the rod end.

NOTE: DO NOT remove or adjust the two port relief valves (Item 2) [Figure 60]. If the port relief valves have been tampered with, see your Bobcat dealer for service.

Figure 61

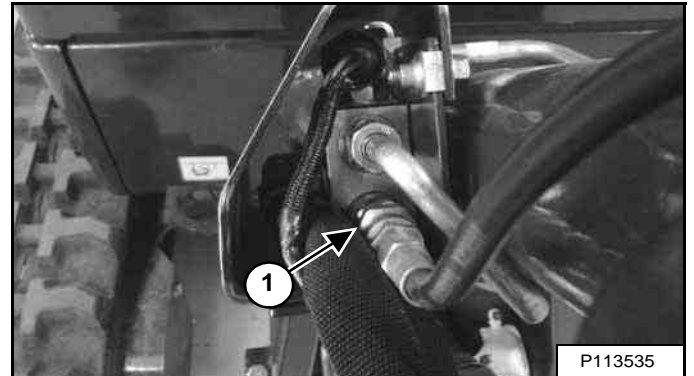

NOTE: DO NOT remove or adjust the port relief valve (Item 1) [Figure 61] (that the drain hose is connected to). If the port relief valve have been tampered with, see your Bobcat dealer for service.

Figure 62

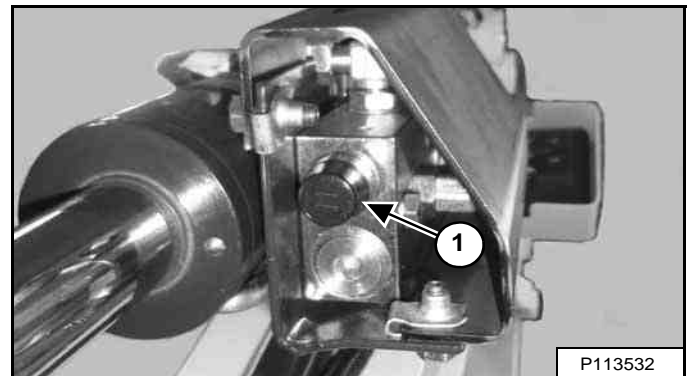

Remove the plastic protective cap (Item 1) [Figure 62] from the valve.

! WARNING

AVOID BURNS

Hydraulic fluid, tubes, fittings and quick couplers can get hot when running machine and attachments. Be careful when connecting and disconnecting quick couplers.

W-2220-0396

BOOM LOAD HOLDING VALVE (CONT'D)

Lowering Boom With Load Holding Valve (Cont'd)

Figure 63

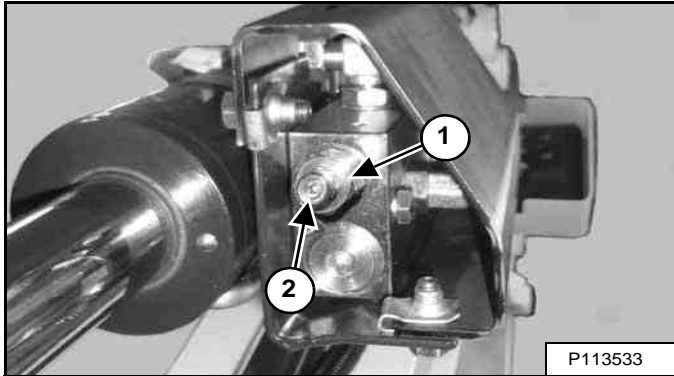

Lowering procedures:

With base end hose failure, or with rod end hose failure and NO accumulator pressure:

NOTE: If the relief valve must be adjusted to lower the boom, the relief valve must be replaced. It can not be reset back to the factory setting.

Loosen the jam nut (Item 1). Install a hex wrench into the valve screw (Item 2) [Figure 63] and slowly rotate the screw clockwise and allow the boom to lower to the ground.

Replace the relief valve [Figure 63]. See your Bobcat dealer for service parts.

With rod end hose failure - with accumulator pressure:

Place a container under the valve and hose end to contain hydraulic fluid. Enter the excavator and turn the key switch to the ON position or press the ENTER CODE Button (Keyless Panel), but do not start the engine. Slowly move the joystick boom lower function and allow the boom to lower to the ground.

Loss of hydraulic pressure:

Use the same procedure as: **With base end hose failure, or with rod end hose failure and NO accumulator pressure.**

ARM LOAD HOLDING VALVE

Description

The arm load holding valve (if equipped) will hold the arm in its current position in the event of hydraulic pressure loss.

! WARNING

AVOID INJURY OR DEATH

Do Not work or stand under raised work equipment or attachment.

W-2793-0409

Lowering Arm With Load Holding Valve

Figure 64

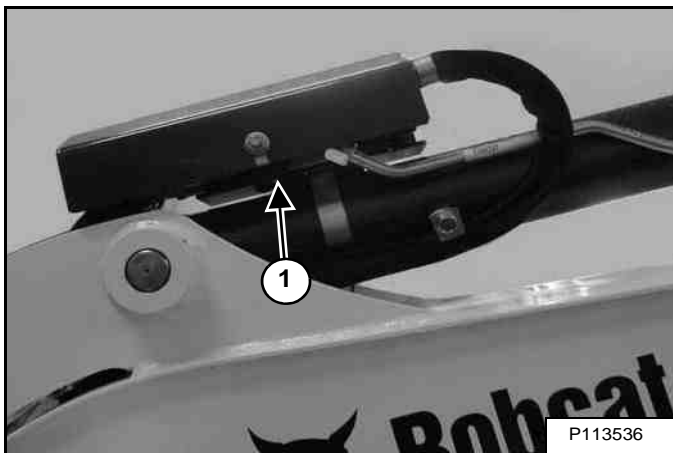

If the excavator is equipped with arm load holding valve (Item 1) [Figure 64], it will be attached to the arm cylinder base end as shown.

Figure 65

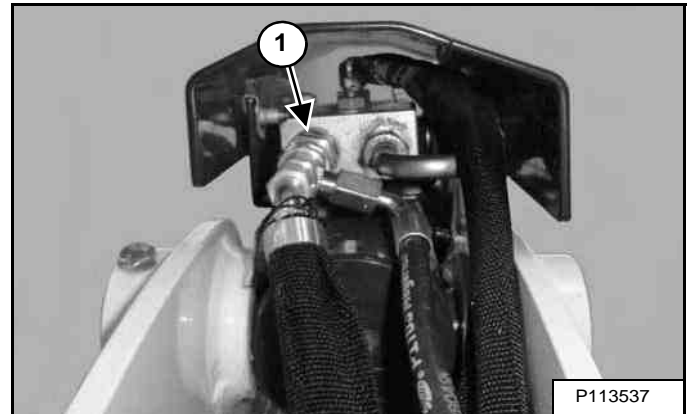

NOTE: DO NOT remove or adjust the port relief valve (Item 1) [Figure 65] (that the drain hose is connected to). If the port relief valve have been tampered with, see your Bobcat dealer for service.

Figure 66

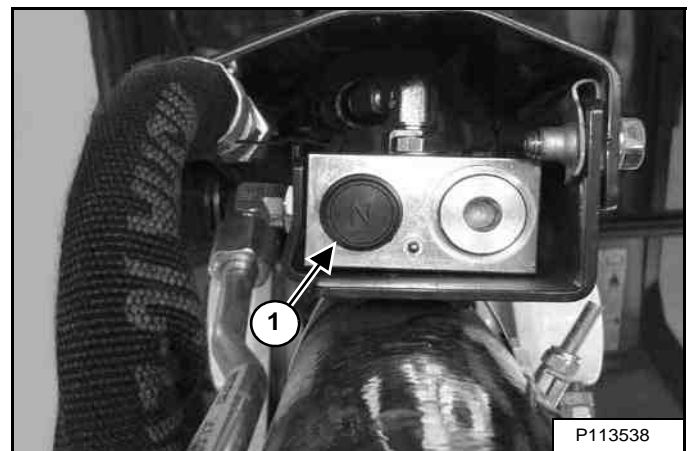

Remove the plastic protective cap (Item 1) [Figure 66] from the valve.

! WARNING

AVOID BURNS

Hydraulic fluid, tubes, fittings and quick couplers can get hot when running machine and attachments. Be careful when connecting and disconnecting quick couplers.

W-2220-0396

ARM LOAD HOLDING VALVE (CONT'D)

Lowering Arm With Load Holding Valve (Cont'd)

Figure 67

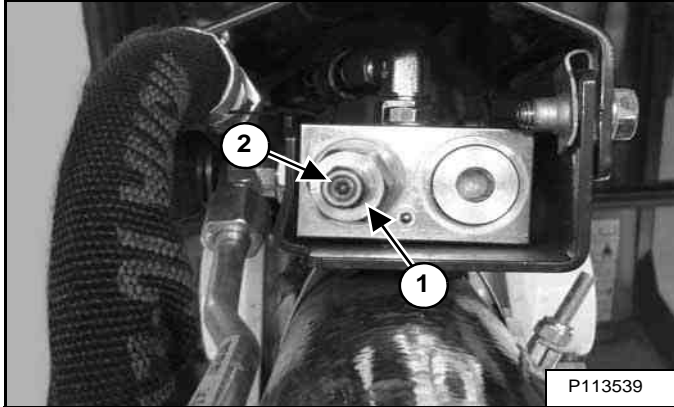

Lowering procedures:

With base end hose failure, or with rod end hose failure and NO accumulator pressure:

NOTE: If the relief valve must be adjusted to lower the boom, the relief valve must be replaced. It can not be reset back to the factory setting.

Loosen the jam nut (Item 1). Install a hex wrench into the valve screw (Item 2) [Figure 67] and slowly rotate the screw clockwise and allow the arm to lower to the ground.

Replace the relief valve [Figure 67]. See your Bobcat dealer for service parts.

With rod end hose failure - with accumulator pressure:

Place a container under the valve and hose end to contain hydraulic fluid. Enter the excavator and turn the key switch to the ON position or press the ENTER CODE Button (Keyless Panel), but do not start the engine. Move the joystick arm retract function to slowly lower the arm.

Loss of hydraulic pressure:

Use the same procedure as: **With base end hose failure, or with rod end hose failure and NO accumulator pressure.**

OVERLOAD WARNING DEVICE

Description

NOTE: The excavator must be equipped with the optional boom load holding valve to installed for the overload warning device.

The overload warning device (if equipped) senses hydraulic pressure in the boom lift circuit. When the hydraulic pressure in the boom lift circuit reaches a predetermined pressure setting, a buzzer will sound that indicates an overload condition.

If the buzzer sounds, immediately move the arm closer to the excavator and lower the boom. Reduce the size of the load before attempting to re-lift the load.



AVOID INJURY OR DEATH

Do Not work or stand under raised work equipment or attachment.

W-2793-0409

Operation

Figure 68

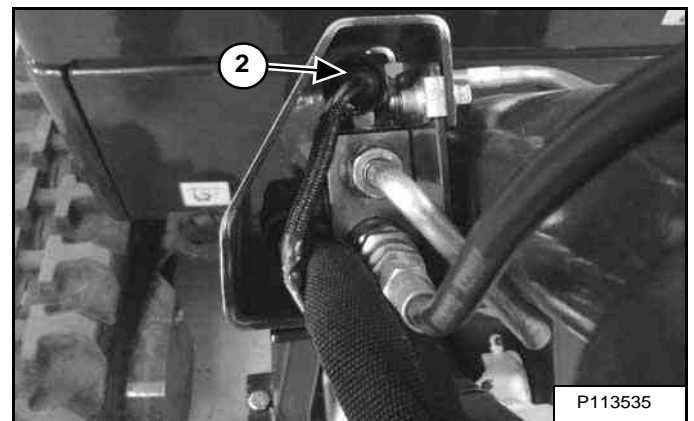

Press the switch (Item 1) to the left. This will activate the optional pressure switch (Item 2) [Figure 68] in the boom load hold valve.

Press the switch (Item 1) [Figure 68] to the right to shut the overload warning feature OFF.

DAILY INSPECTION

Daily Inspection And Maintenance

Figure 69

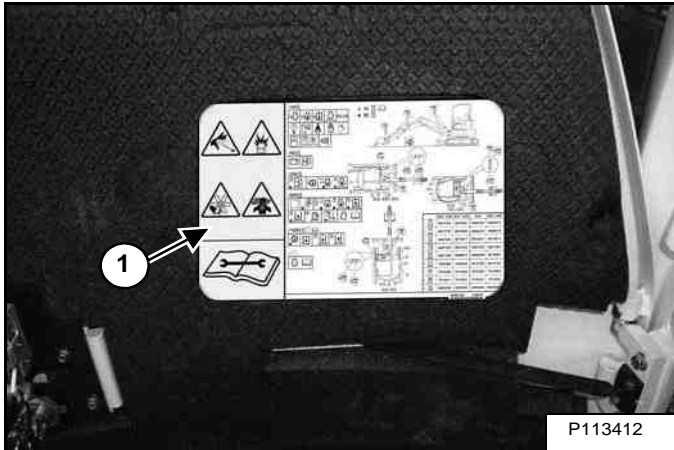

Maintenance work must be done at regular intervals. Failure to do so will result in excessive wear and early failures. The service schedule is a guide for correct maintenance of the Bobcat excavator. The decal (Item 1) [Figure 69] is located on the inside of the tailgate. (See SERVICE SCHEDULE on Page 103.)

Check the following items before each day of operation:

- Operator Canopy or Cab (ROPS / TOPS) and mounting hardware.
- Seat belt and mounting hardware. Replace seat belt if damaged.
- Check for damaged decals, replace as needed.
- Check control console lockout.
- Check Attachment Mounting System (if equipped) for damage or loose parts.
- Air cleaner and intake hoses / clamps.
- Engine oil level and engine for leaks.
- Drain water from fuel filter.
- Engine coolant level and engine for leaks.
- Check engine area for flammable materials.
- Check hydraulic fluid level and system for leaks.
- Check indicator lights for correct operation.
- Grease all pivot points.
- Check cylinder and attachment pivot points.
- Check the track tension.
- Repair broken and loose parts.
- Clean cab heater filter (if equipped).
- Check front horn and motion alarm (if equipped) for proper function.

WARNING

Operator must have instructions before operating the machine. Untrained operators can cause injury or death.

W-2001-0502

Fluids such as engine oil, hydraulic fluid, coolants, etc. must be disposed of in an environmentally safe manner. Some regulations require that certain spills and leaks on the ground must be cleaned in a specific manner. See local for correct disposal.

IMPORTANT

PRESSURE WASHING DECALS

- Never direct the stream at a low angle toward the decal that could damage the decal causing it to peel from the surface.
- Direct the stream at a 90 degree angle and at least 300 mm (12 in) from the decal. Wash from the centre of the decal toward the edges.

I-2226-EN-0910

IMPORTANT

This machine is factory equipped with a spark arrester exhaust system.

The spark arrester muffler, if equipped, must be cleaned to keep it in working condition. The spark arrester muffler must be serviced by dumping the spark chamber every 100 hours of operation.

On some models, the turbocharger functions as the spark arrester and must operate correctly for proper spark arrester function.

If this machine is operated on flammable forest, brush, or grass covered land, a spark arrester attached to the exhaust system may be required and must be maintained in working order. Refer to local laws and regulations for spark arrester requirements.

I-2284-EN-0909

PRE-STARTING PROCEDURE

Operation & Maintenance Manual And Operator's Handbook Locations

Figure 70



Figure 71



Read and understand the Operation & Maintenance Manual (Item 1) [Figure 70] (located inside the storage box below the operator's seat) and the Operator's Handbook (Item 1) [Figure 71] located behind the operator's seat before operating.

Entering The Excavator

Figure 72



Use the grab handles and tracks to enter the canopy / cab [Figure 72].



AVOID INJURY OR DEATH

Instructions are necessary before operating or servicing machine. Read and understand the Operation & Maintenance Manual and signs (decals) on machine. Follow warnings and instructions in the manuals when making repairs, adjustments or servicing. Check for correct function after adjustments, repairs or service. Untrained operators and failure to follow instructions can cause injury or death.

W-2003-EN-0614

PRE-STARTING PROCEDURE (CONT'D)

Seat Adjustment

Basic Seat (If Equipped)

Figure 73



The basic seat has no adjustments [Figure 73].

Standard Seat (If Equipped)

Figure 74



Release the seat lever (Item 1) [Figure 74] to adjust the seat forward or back.

Release the seat lever (Item 2) [Figure 74] to adjust the position of the back cushion.

Suspension Seat (If Equipped)

Figure 75



Release the seat lever (Item 1) [Figure 75] to adjust the seat forward or back.

Turn the handle (Item 2) [Figure 75] to change the adjustment for operator weight.

Release the lever (Item 3) [Figure 75] to change the incline of the seat back.

Seat Belt

Figure 76



Fasten the seat belt [Figure 76].

PRE-STARTING PROCEDURE (CONT'D)

Control Console

Figure 77

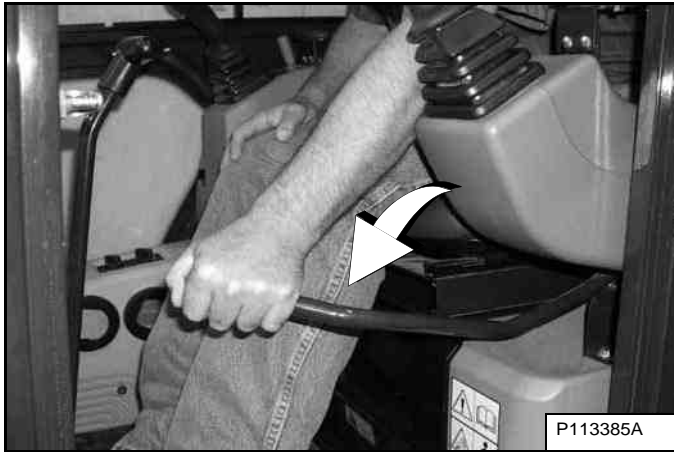

Lower the control console [Figure 77].

NOTE: There is a control lock sensor in the left console which deactivates the hydraulic control levers (joysticks) and the traction drive system when the control console is raised. The console must be in the locked down position for the hydraulic control levers (joysticks) and traction system to operate.

NOTE: If the control lock sensor does not deactivate the control levers and traction system when console is raised, see your Bobcat dealer for service.

Mirror Adjustment

Figure 78

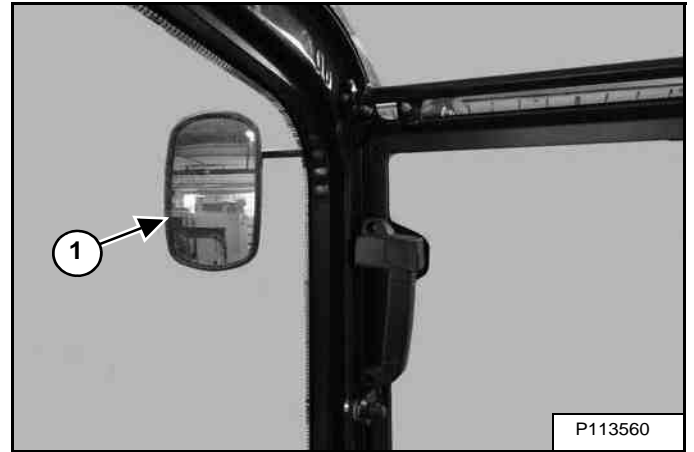

Adjust mirror(s) (Item 1) [Figure 78] (if equipped).

STARTING THE ENGINE

Key Switch



AVOID INJURY OR DEATH

- Fasten seat belt, start and operate only from the operator's seat.
- Never wear loose clothing when working near machine.

W-2135-1108

Perform the PRE-STARTING PROCEDURE. (See PRE-STARTING PROCEDURE on Page 65.)

Figure 79

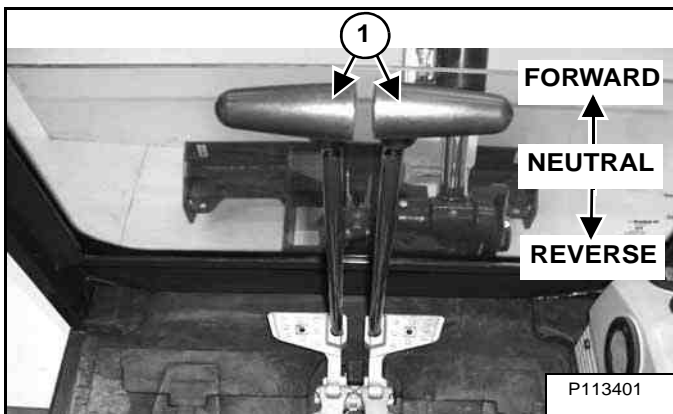

Put control levers (Item 1) [Figure 79] in the NEUTRAL position.

Figure 80

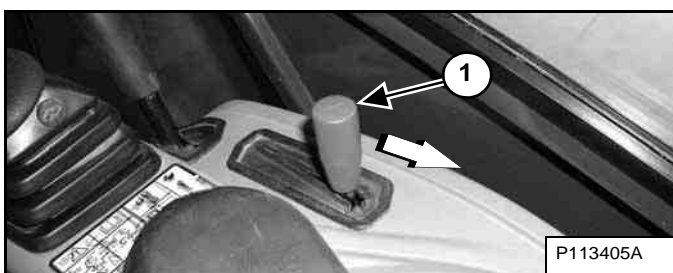

Move the engine speed control lever (Item 1) [Figure 80] back to low idle.



Do not engage the starter for longer than 15 seconds at a time. Longer use can damage the starter by overheating. Allow starter to cool for one minute before using starter again.

I-2034-0700

Figure 81

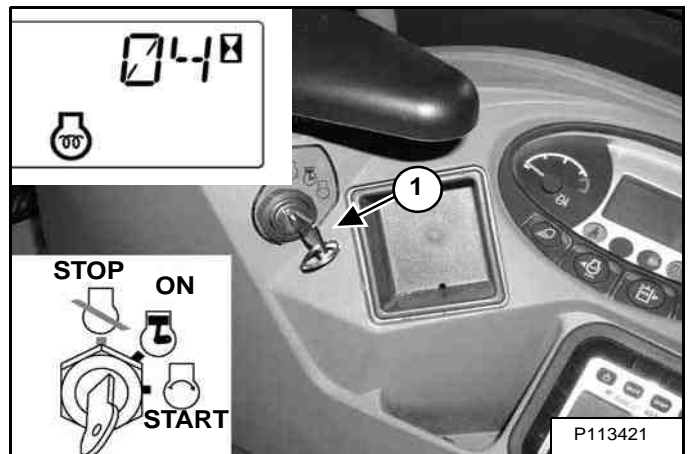

Turn the key (Item 1) [Figure 81] to the ON position. If preheating is required, the glow plugs will automatically cycle and the remaining preheat time (in seconds) will show in the data display screen (see inset). (Preheat icon will be ON).

NOTE: It is recommended in cold weather to cycle the glow plugs twice before attempting to start the engine. This will allow for additional heating time for cold weather starting.

Turn the key to START and release the key when the engine starts. It will return to the ON position [Figure 81].

Stop the engine if the warning lights and alarm do not go OFF. Check for the cause before starting the engine again.

Turn the key switch OFF to stop the engine.



AVOID INJURY OR DEATH

When an engine is running in an enclosed area, fresh air must be added to avoid concentration of exhaust fumes. If the engine is stationary, vent the exhaust outside. Exhaust fumes contain odorless, invisible gases which can kill without warning.

W-2050-0807



AVOID SERIOUS INJURY OR DEATH

- Engines can have hot parts and hot exhaust gas. Keep flammable material away.
- Do not use machines in atmosphere containing explosive dust or gases.

W-2051-0212

STARTING THE ENGINE (CONT'D)

Keyless

! WARNING

AVOID INJURY OR DEATH

- Fasten seat belt, start and operate only from the operator's seat.
- Never wear loose clothing when working near machine.

W-2135-1108

Perform the PRE-STARTING PROCEDURE. (See PRE-STARTING PROCEDURE on Page 65.)

Figure 82

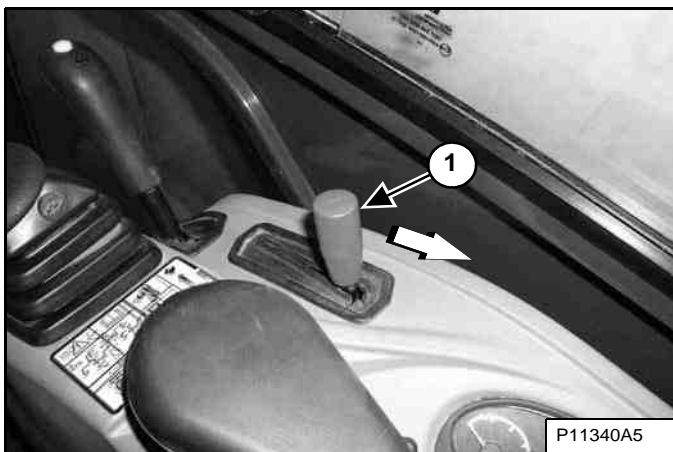

Move the engine speed control lever (Item 1) [Figure 82] back to low idle.

Figure 83

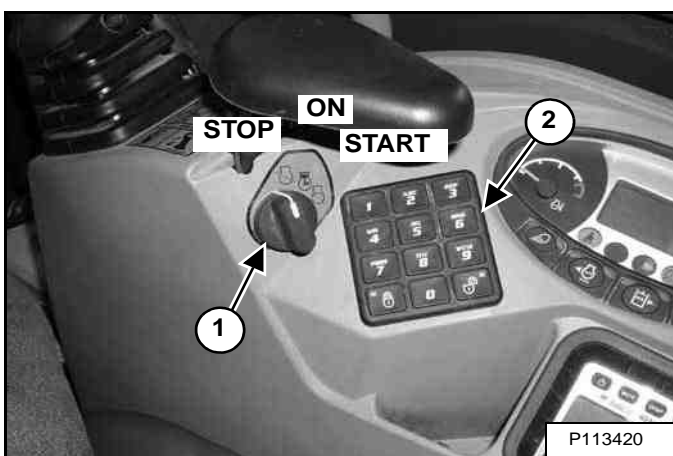

Turn the start switch (Item 1) [Figure 83] to ON. The indicator lights on the instrument panel will come ON briefly and the Instrument Panel / monitoring system will do a self test.

Use the keypad (Item 2) [Figure 83] to enter the password.

Figure 84

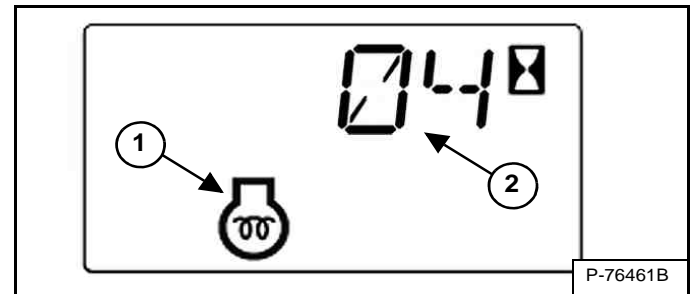

If preheating is required, the glow plugs will automatically cycle based on temperature. The engine preheat icon (Item 1) will be ON and the cycle time remaining (Item 2) [Figure 84] will be shown on the data display.

NOTE: It is recommended in cold weather to cycle the glow plugs twice before attempting to start the engine. This will allow for additional heating time for cold weather starting.

When the engine preheat icon goes OFF, turn the start switch (Item 1) [Figure 83] to START position and hold it until the engine starts. Release the switch and it will return to the ON position.

IMPORTANT

Do not engage the starter for longer than 15 seconds at a time. Longer use can damage the starter by overheating. Allow starter to cool for one minute before using starter again.

I-2034-0700

Turn the start switch (Item 1) [Figure 83] to the STOP position to stop the engine.

Stop the engine if the warning lights and alarm do not go OFF.

Check for the cause before starting the engine again.

Password Lockout Feature

See Password Lockout Feature. (See Password Lockout Feature on Page 151.)



STARTING THE ENGINE (CONT'D)

Warming The Hydraulic System

IMPORTANT

When the temperature is below -30°C (-20°F), hydrostatic oil must be warmed before starting. The hydrostatic system will not get enough oil at low temperatures and will be damaged. Park the machine in an area where the temperature will be above -18°C (0°F) if possible.

I-2007-0910

Let the engine run at least 5 minutes to warm the engine and hydraulic fluid before operating the excavator.

Cold Temperature Starting

! WARNING

EXPLOSION CAN CAUSE SERIOUS INJURY, DEATH OR SEVERE ENGINE DAMAGE

DO NOT use ether or starting fluid with glow plug or air intake heater systems.

W-2071-0415

If the temperature is below freezing, perform the following to make starting the engine easier:

- Replace the engine oil with the correct type and viscosity for the anticipated starting temperature. (See Engine Oil Chart on Page 118.)
- Make sure the battery is fully charged.
- Install an engine heater.

NOTE: If the battery is discharged (but not frozen) a booster battery can be used to jump start the excavator. (See Using A Booster Battery (Jump Starting) on Page 126.)

NOTE: The display screen on the instrument panel may not be at full intensity when the temperature is below -26°C (-15°F). The display screen may take 30 seconds to several minutes to warm up. All systems remain monitored even when the display screen is off.

MONITORING THE DISPLAY PANELS

Instrument Panel

Figure 85



Frequently monitor the temperature and fuel gauges [Figure 85].

After the engine is running, frequently monitor the instrument panel [Figure 85] for machine condition.

The associated icon is displayed if there is an error condition.

EXAMPLE: Engine Coolant Temperature is High.

The Engine Coolant Temperature icon (Item 1) [Figure 85] is ON.

Press the Information button (Item 2) [Figure 85] repeatedly to cycle the data display until the service code screen is displayed. One of the following SERVICE CODES is displayed.

- [M0810] Engine Coolant Temperature Too High
- [M0811] Engine Coolant Temperature Extremely High

Find the cause of the service code and correct before operating the excavator again. (See DIAGNOSTIC SERVICE CODES on Page 147.)

Warning And Shutdown

When a WARNING condition exists; the associated icon light is ON and the alarm sounds 3 beeps. If this condition is allowed to continue, there may be damage to the engine or hydraulic systems.

When a SHUTDOWN condition exists; the associated icon light is ON and the alarm sounds continuously. The monitoring system will automatically stop the engine in 15 seconds. The engine can be restarted to move or relocate the excavator.

The SHUTDOWN feature is associated with the following icons:

- General Warning
- Engine Malfunction
- Engine Coolant Temperature

STOPPING THE ENGINE AND LEAVING THE EXCAVATOR

Procedure

Figure 86



Expand the tracks fully. Stop the machine on level ground. Lower the work equipment and the blade to the ground [Figure 86].

Figure 87

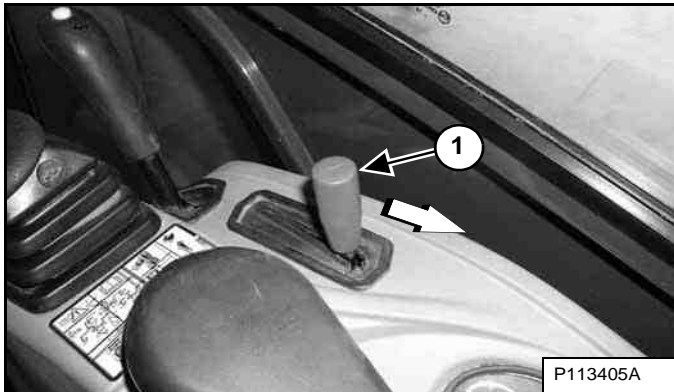

Move the engine speed control lever (Item 1) [Figure 87] back to low idle.

Run the engine at idle speed for about 5 minutes to allow it to cool.

Figure 88

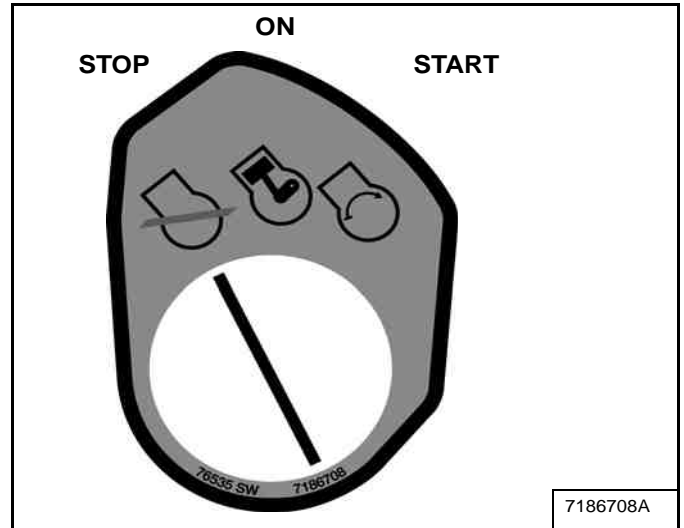

Turn the switch to STOP [Figure 88].

Disconnect the seat belt. Remove the key from the switch (If Equipped) to prevent operation of machine by unauthorised personnel. Raise the control console and exit the machine.

ATTACHMENTS

Installing And Removing The Attachment (Pin-On Attachment)

Installation



AVOID INJURY OR DEATH

Stop the machine on a firm flat surface. When removing or installing attachments (such as a bucket), always have a second person in the operator's seat, give clear signals and work carefully.

W-2140-0189

Figure 89

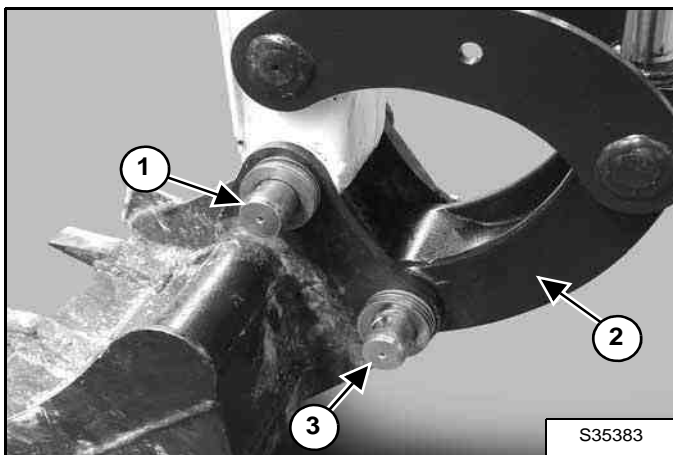

Install the arm into the bucket and align the mounting hole.

Install the pin (Item 1) [Figure 89] and washers.

Install the link (Item 2) in the bucket and align the mounting hole. Install the pin (Item 3) [Figure 89] and washers

Figure 90

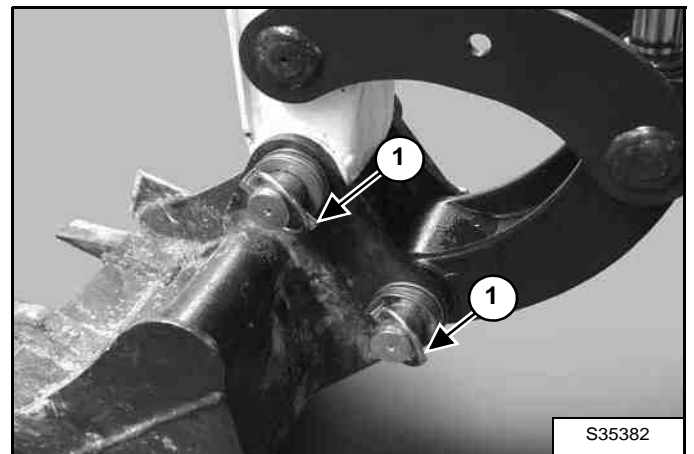

Install the two retainer pins (Item 1) [Figure 90]. Install grease in the grease fittings.

Removal

Park the excavator on a flat surface and lower the bucket fully.

Remove the two retainer pins (Item 1) [Figure 90].

Remove the washers and pins (Items 1 and 3) [Figure 89].

Do not damage the dust seals in the arm.



AVOID INJURY OR DEATH

Never use attachments or buckets which are not approved by Bobcat Company. Buckets and attachments for safe loads of specified densities are approved for each model. Unapproved attachments can cause injury or death.

W-2052-0907

ATTACHMENTS (CONT'D)

Bobcat Quick Coupler (BQC) Type SW

! WARNING

AVOID INJURY OR DEATH

Never use attachments or buckets which are not approved by Bobcat Company. Buckets and attachments for safe loads of specified densities are approved for each model. Unapproved attachments can cause injury or death.

W-2052-0907

! WARNING

AVOID INJURY OR DEATH

Stop the machine on a firm flat surface. When removing or installing attachments (such as a bucket), always have a second person in the operator's seat, give clear signals and work carefully.

W-2140-0189

NOTE: Installation and removal of a bucket is shown. The procedure for other attachments is similar. Disconnect all hydraulic connections prior to removing the attachment (breaker, auger, etc.)

Installation

Step 1: Preparation

Park the excavator on a level surface and put the bucket flat on the ground.

Start the engine.

Fully retract the bucket cylinder.

Step 2: Connecting

Figure 91

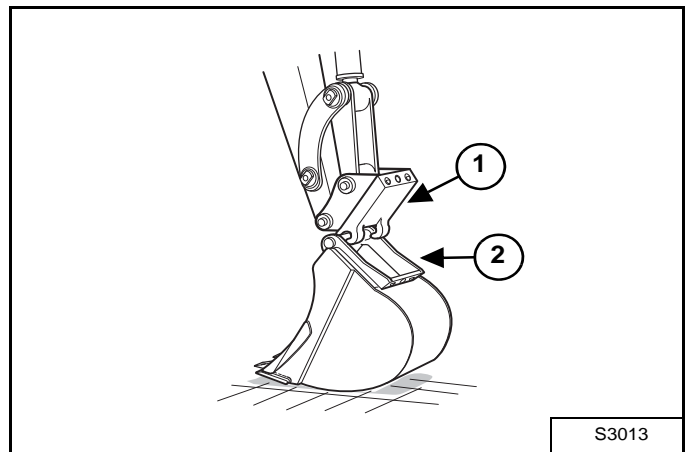

Lower the BQC (Item 1) onto the adapter (Item 2) [Figure 91] of the bucket.

Figure 92

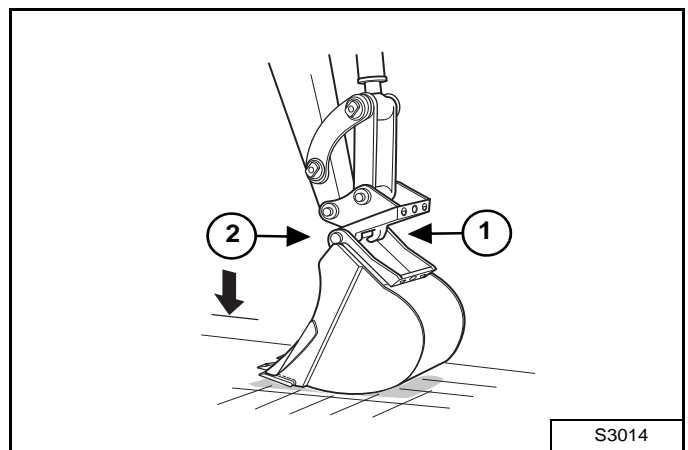

Engage the coupling claws (Item 1) of the BQC onto the coupling shaft (Item 2) [Figure 92].

ATTACHMENTS (CONT'D)

Bobcat Quick Coupler (BQC) Type SW (Cont'd)

Installation (Cont'd)

Figure 93

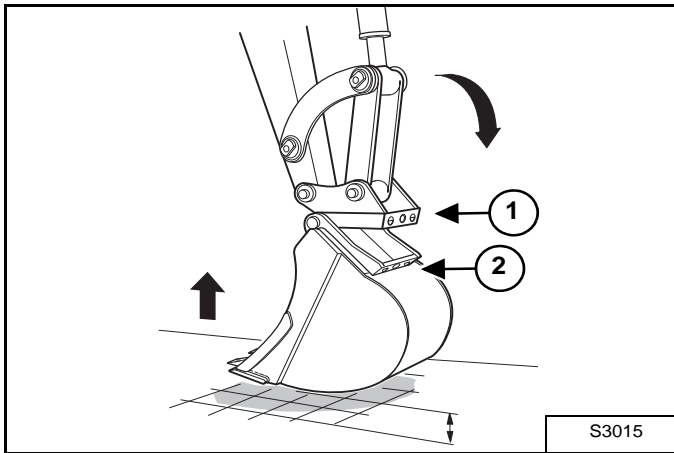

Extend the bucket cylinder and lift the boom until the top of the BQC (Item 1) engages the edge (Item 2) [Figure 93] of the bucket adapter.

Step 3: Securing

Figure 94

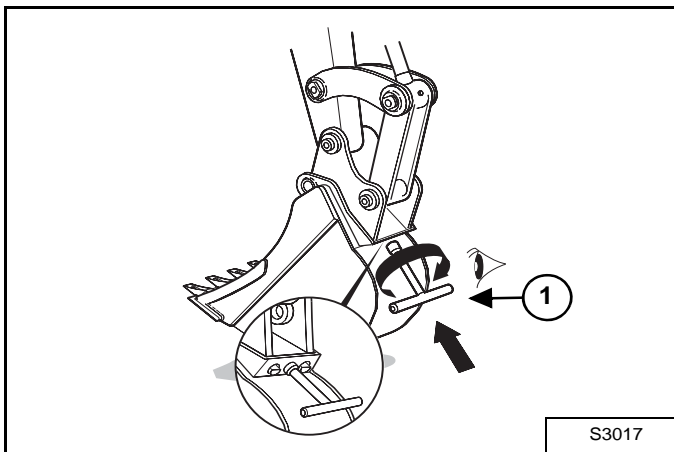

Insert the socket wrench (Item 1) [Figure 94] into the locking plate and turn clockwise until the locking pins are engaged. Visually check to ensure that the locking pins are fully engaged.

Removal

Park the excavator on a level surface and put the bucket flat on the ground.

Figure 95

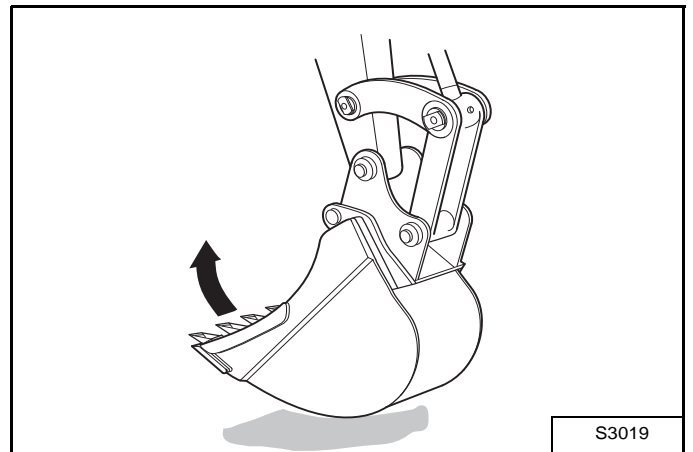

Raise and tilt in the bucket [Figure 95].

Figure 96

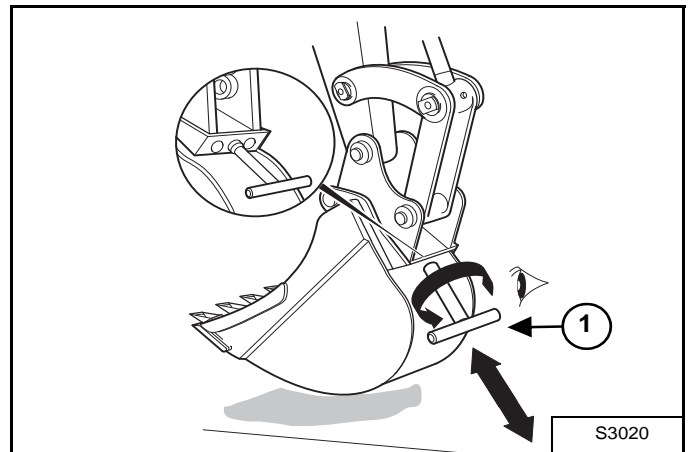

Insert the socket wrench (Item 1) [Figure 96] into the locking plate and turn anticlockwise to let the locking come loose.

ATTACHMENTS (CONT'D)

Bobcat Quick Coupler (BQC) Type SW (Cont'd)

Removal (Cont'd)

Figure 97

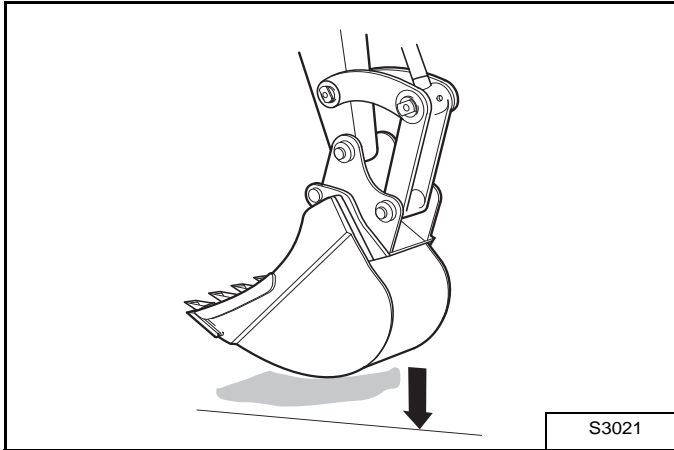

Set down the bucket to a stable position on level ground [Figure 97].

Figure 98

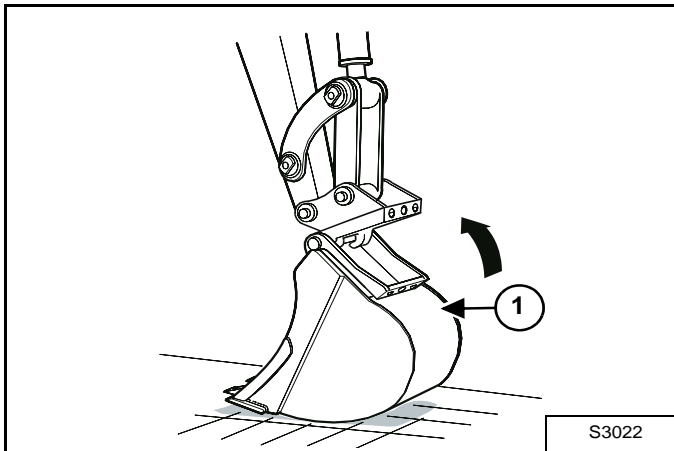

Retract the bucket cylinder to swivel the BQC out of the adapter [Figure 98].

Figure 99

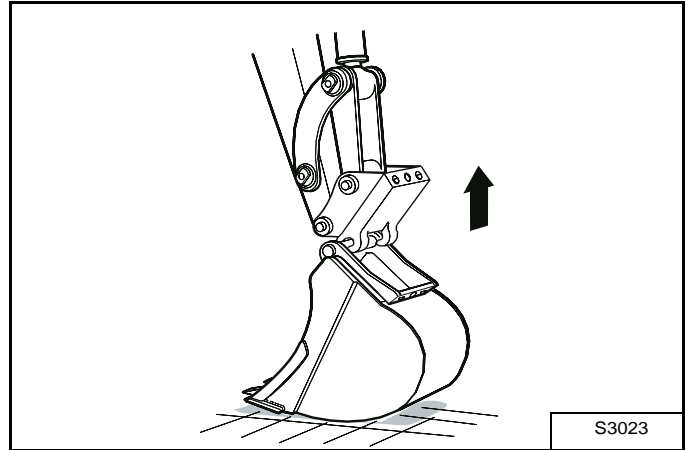

Disengage the BQC and raise the arm [Figure 99].

ATTACHMENTS (CONT'D)

Installing And Removing The Attachment (Bobcat Quick Coupler (BQC) Type K)

Installation

NOTE: Installation and removal of the bucket is shown. The procedure is the same for other attachments. Disconnect any hydraulic lines that are operated by hydraulic power before removing any attachments (breaker, auger etc.).



AVOID INJURY OR DEATH

Never use attachments or buckets which are not approved by Bobcat Company. Buckets and attachments for safe loads of specified densities are approved for each model. Unapproved attachments can cause injury or death.

W-2052-0907

Figure 100

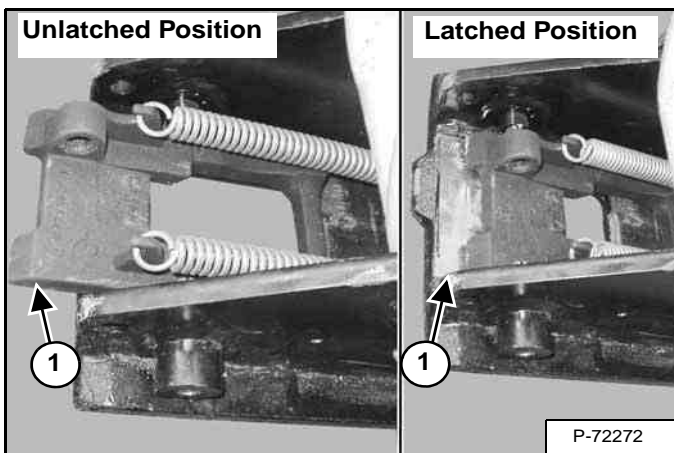

Fully retract the bucket cylinder.

Stop the engine and exit the excavator.

Inspect the quick coupler to make sure the latch is in the unlatched position (Item 1) [Figure 100].

If in the latched position, see [Figure 101] for additional information.

If the latch is in the unlatched position, proceed to [Figure 102].



AVOID INJURY

Keep fingers and hands out of pinch points when latching and unlatching the attachment quick coupler.

W-2541-1106

Figure 101

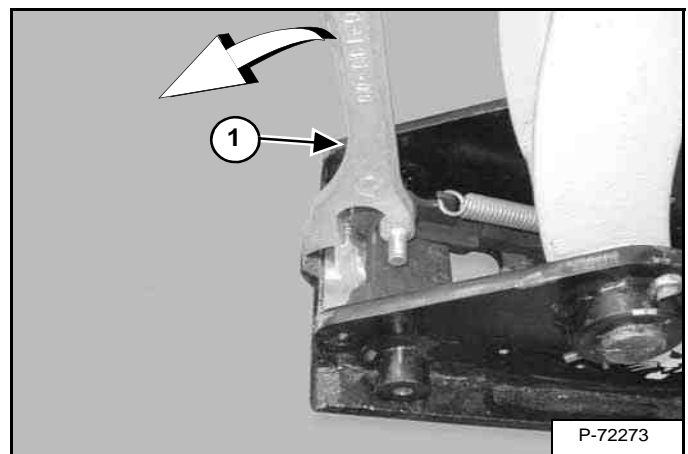

To unlatch the quick coupler, install the tool (Item 1) [Figure 101] and pull the handle. The latch will move completely forward. The latch will lock in the unlatched position.

Figure 102

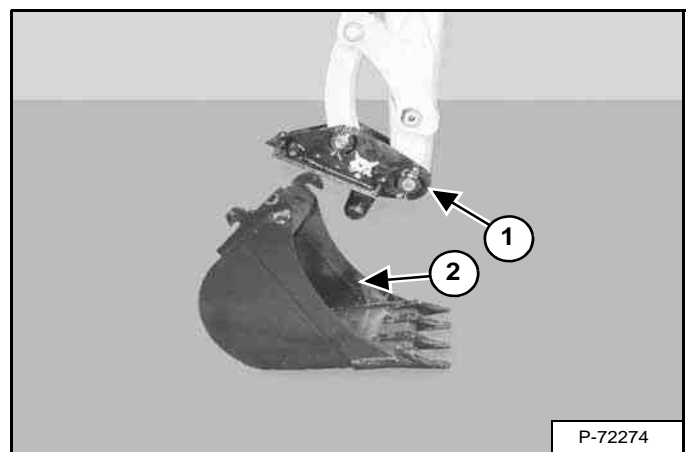

Enter the excavator, fasten the seat belt and start the engine.

Position the quick coupler (Item 1) to the attachment (Item 2) [Figure 102].

ATTACHMENTS (CONT'D)

Installing And Removing The Attachment (Bobcat Quick Coupler (BQC) Type K) (Cont'd)

Installation (Cont'd)

Figure 103

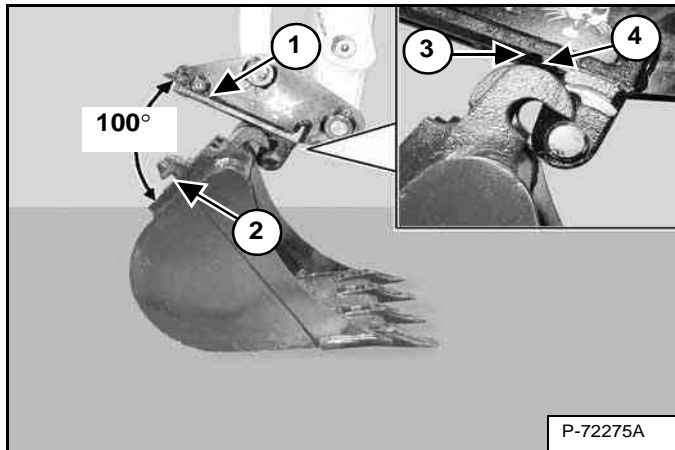

There must be at least 100° between the quick coupler surface (Item 1) and the attachment mounting surface (Item 2) [Figure 103]. Extend the arm out to get the required angle for proper installation.

NOTE: There must be proper clearance (100° minimum) between the hook (Item 3) and the quick coupler (Item 4) [Figure 103]. Possible damage to the attachment hooks or the quick coupler could occur without proper clearance.

Figure 104

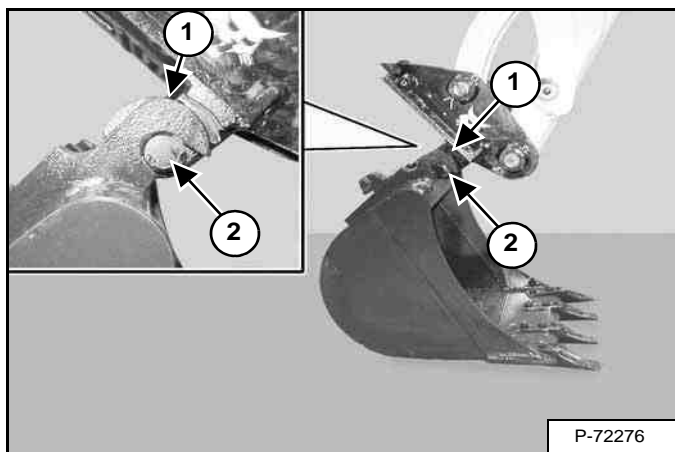

Raise the boom and extend the arm until the hooks of the attachment (Item 1) engage the pins (Item 2) of the quick coupler [Figure 104].

Figure 105

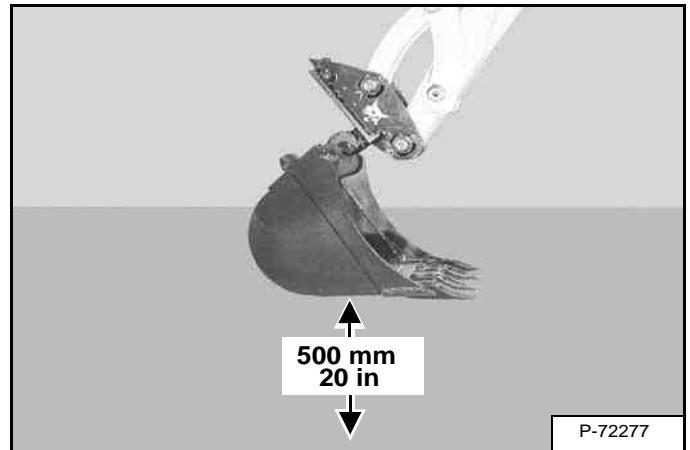

Raise the boom until there is approximately 500 mm (20.0 in) of clearance between the bottom of the attachment and the ground [Figure 105].

Figure 106

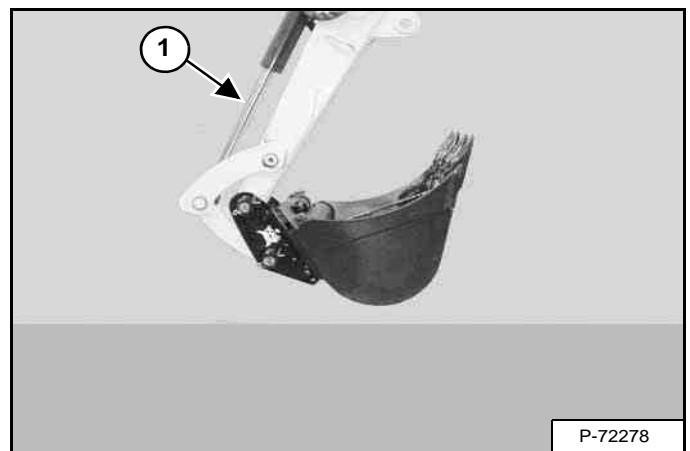

Extend the bucket cylinder (Item 1) [Figure 106] fully.

Lower the attachment until it is flat on the ground.

Engage the parking brake.

Stop the engine and exit the excavator.

ATTACHMENTS (CONT'D)

Installing And Removing The Attachment (Bobcat Quick Coupler (BQC) Type K) (Cont'd)

Installation (Cont'd)

Figure 107

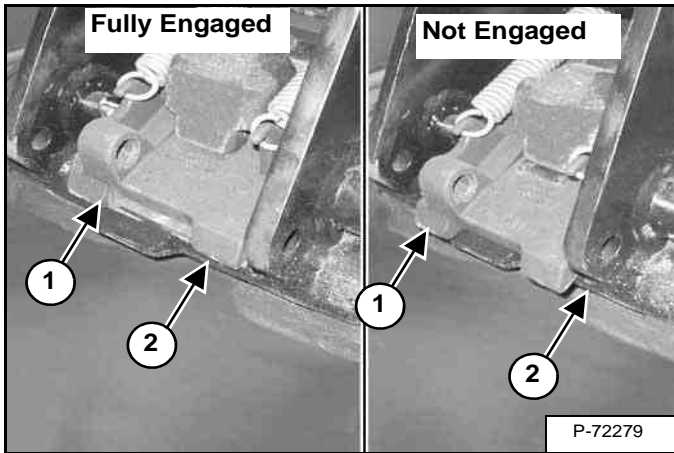

Visually inspect the quick coupler latch (Item 1) to the bucket mount (Item 2) [Figure 107]. The latch must be fully engaged.



AVOID INJURY

Keep fingers and hands out of pinch points when latching and unlatching the attachment quick coupler.

W-2541-1106

Figure 108

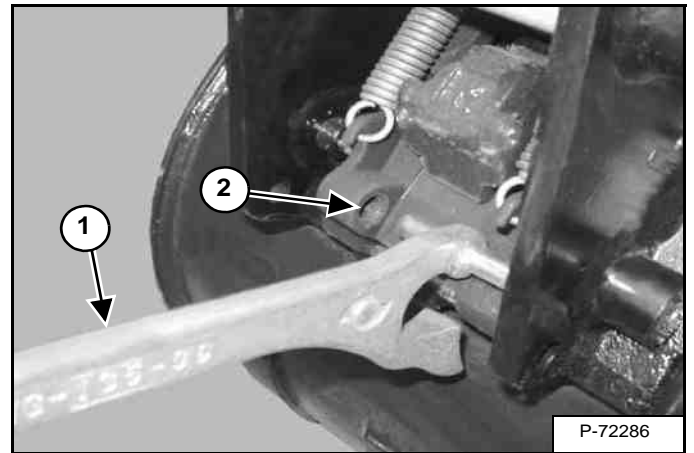

If the latch is not engaged, install the tool (Item 1) in the hole (Item 2) [Figure 108] of the quick coupler and push down to unlatch the quick coupler. Remove the tool. Enter the excavator, fasten the seat belt and start the engine. Raise the attachment 500 mm (20.0 in) off of the ground and fully extend the bucket cylinder. Lower the attachment until it is flat on the ground. Engage the parking brake. Stop the engine and exit the excavator.

Again, visually inspect the quick coupler to make sure the latch (Item 1) [Figure 107] is fully engaged. If it is not fully engaged, remove the attachment and inspect both the quick coupler and the attachment for damage or debris. (See [Figure 112] for *Quick Coupler And Attachment Inspection* information.)

ATTACHMENTS (CONT'D)

Installing And Removing The Attachment (Bobcat Quick Coupler (BQC) Type K) (Cont'd)

Removal

! WARNING

AVOID INJURY

Keep fingers and hands out of pinch points when latching and unlatching the attachment quick coupler.

W-2541-1106

Figure 109

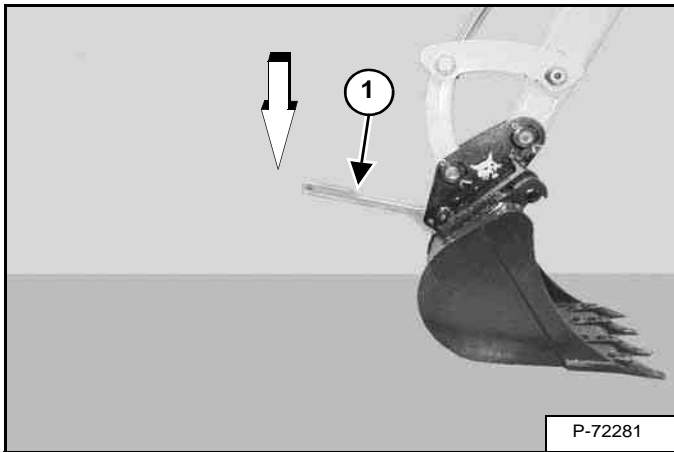

Position the attachment flat on the ground.

Install the quick coupler tool (Item 1) into the hole (Item 2) [Figure 108] in the quick coupler.

Push down on the tool (Item 1) [Figure 109] to unlock the latch.

Remove the tool.

Enter the excavator, fasten the seat belt and start the engine.

Figure 110

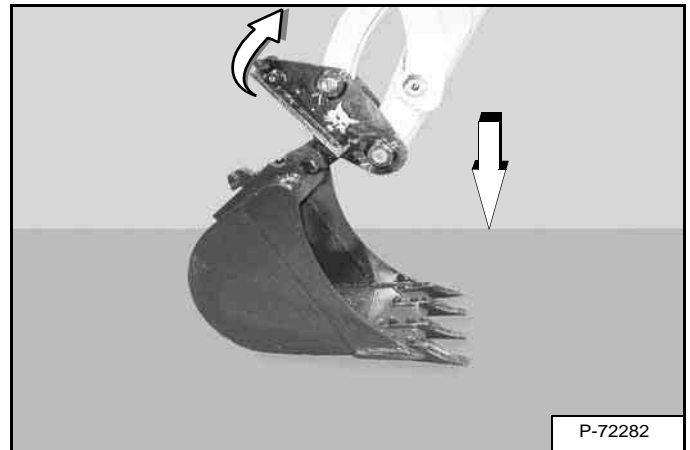

Retract the bucket cylinder fully and lower the boom [Figure 110] until the attachment is on the ground.

Figure 111

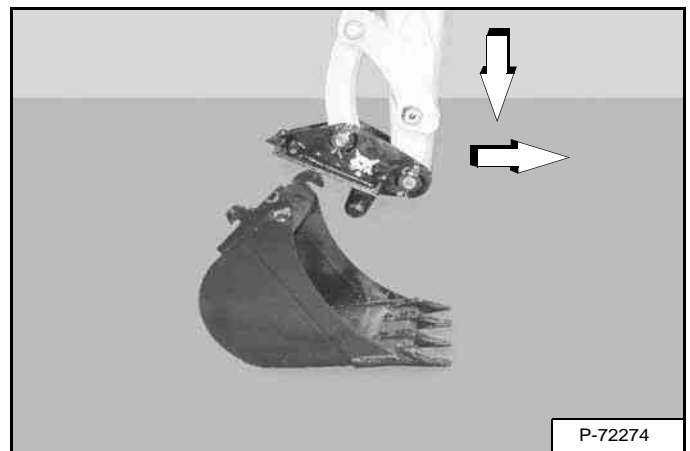

Continue to lower the boom and move the arm towards the excavator until the quick coupler is clear of the attachment [Figure 111].

ATTACHMENTS (CONT'D)

Installing And Removing The Attachment (Bobcat Quick Coupler (BQC) Type K) (Cont'd)

Quick Coupler And Attachment Inspection

Figure 112

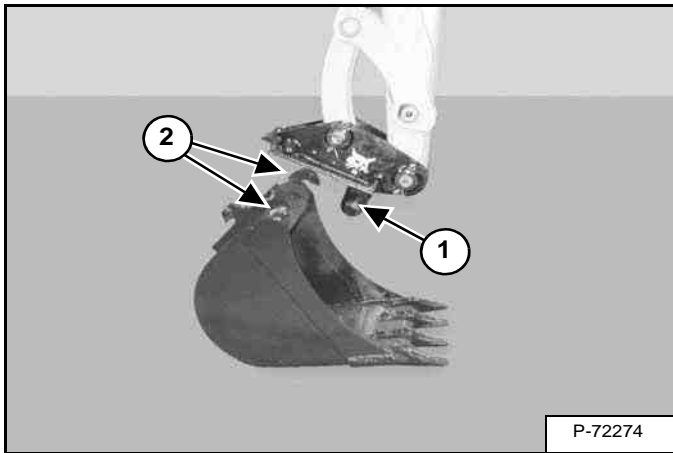

Inspect the quick coupler for wear or damage. Inspect the quick coupler pins (Item 1) and the hooks (Item 2) [Figure 112] (on the attachment) for wear or damage.

Repair or replace damaged parts.

OPERATING PROCEDURE

Inspect The Work Area

Before beginning operation, inspect the work area for unsafe conditions.

Look for sharp drop-offs or rough terrain. Have underground utility lines (gas, water, sewer, irrigation, etc.) located and marked. Work slowly in areas of underground utilities.

Remove objects or other construction material that could damage the excavator or cause personal injury.

Always check ground conditions before starting your work:

- Inspect for signs of instability such as cracks or settlement.
- Be aware of weather conditions that can affect ground stability.
- Check for adequate traction if working on a slope.

Basic Operating Instructions

When operating on a public road or motorway, always follow local regulations. For example: A slow moving vehicle (SMV) sign, or direction signals can be required.

Run the engine at low idle speed to warm the engine and hydraulic system before operating the excavator.

IMPORTANT

Machines warmed up with moderate engine speed and light load have longer life.

I-2015-0284

New operators must operate the excavator in an open area without bystanders. Operate the controls until the excavator can be handled at an efficient and safe rate for all conditions of the work area.

Operating Near An Edge Or Water

Keep the excavator as far back from the edge as possible and the excavator tracks perpendicular to the edge so that if part of the edge collapses, the excavator can be moved back.

Always move the excavator back at any indication the edge may be unstable.

Lowering The Work Equipment (Engine STOPPED)

The hydraulic control levers control the movement of the boom, arm, bucket and upperstructure slew functions.

The console must be in the locked down position, and the key switch in the ON position.

Use the control lever to lower the boom.

Figure 113

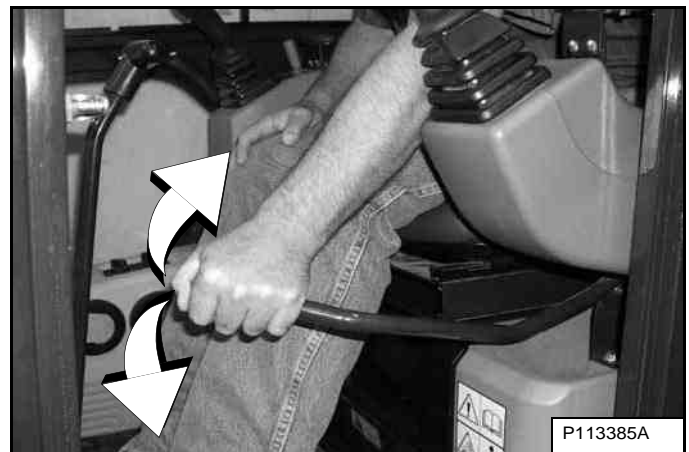

The joystick lock switch disengages the hydraulic control functions from the joysticks when the console are raised [Figure 113].

NOTE: If the engine stops, the boom / bucket (attachments) can be lowered to the ground using hydraulic pressure in the accumulator.

The control console must be in the locked down position, and the key switch in the ON position.

Use the control lever to lower the boom.

Lower the control console to engage the hydraulic control functions of the joysticks [Figure 113].

OPERATING PROCEDURE (CONT'D)

Object Handling

The excavator must be equipped with the optional lift eye link (Item 1) [Figure 114], the boom and arm load hold valves and the overload warning device option. See your Bobcat dealer for available Kits.

Do not exceed the Rated Lift Capacity. (See MACHINE SIGNS (DECALS) on Page 22.)

WARNING

AVOID INJURY OR DEATH

- Do not exceed rated lift capacity.
- Excessive load can cause tipping or loss of control.
- Excessive load can cause failure of the lift eye and cause the load to drop.

W-2991-0714

Extend the bucket cylinder completely and lower the boom to the ground. Stop the engine. Exit the excavator. (See STOPPING THE ENGINE AND LEAVING THE EXCAVATOR on Page 72.)

Figure 114

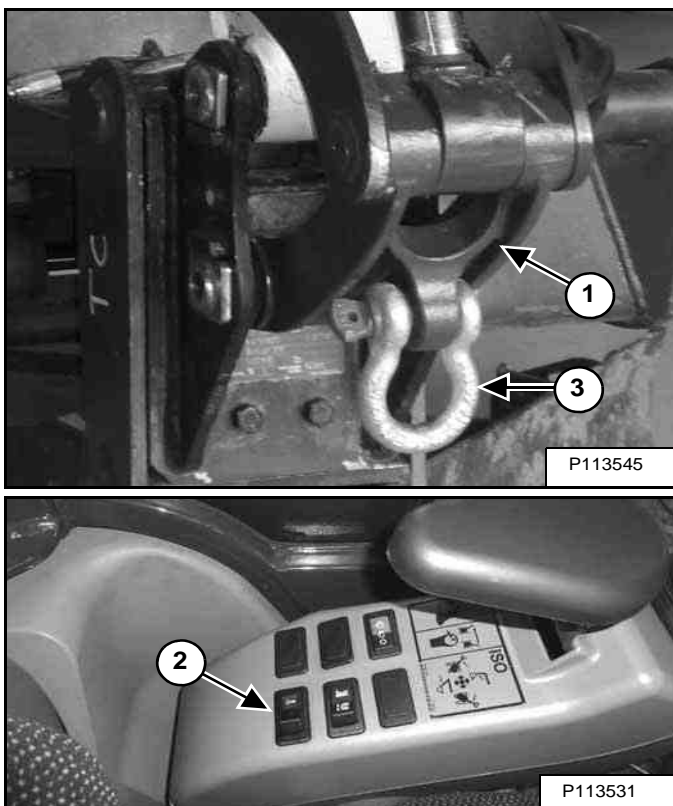

Install a clevis (Item 3) through the lift eye (Item 1) [Figure 114].

NOTE: Visually check the lifting eye, the clevis and the lifting chain (lifting device) for any damage. Replace any damage components before lifting.

Figure 115

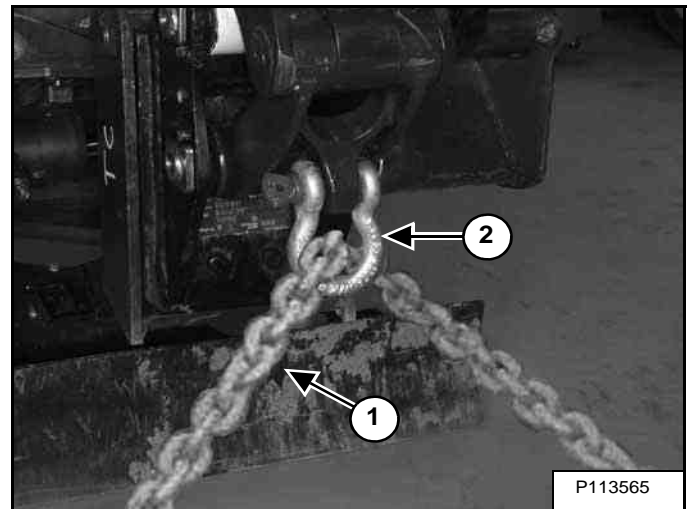

Install a lift chain (Item 1) (or other type of lifting device) through the clevis (Item 2) [Figure 115] and connect to the object to be lifted.

NOTE: Always use chains or other types of lifting devices that are intended for this type of use and that are of adequate strength for the object being lifted.

Enter the excavator, fasten the seat belt and start the engine. (See PRE-STARTING PROCEDURE on Page 65.)

Press the switch (Item 2) [Figure 114] to the left to activate the overload warning device.

Figure 116

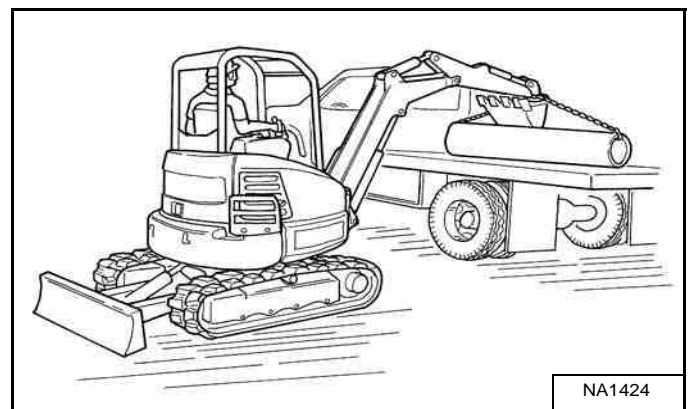

Make sure the load is evenly weighted and centered on the lifting chain (or other type of lifting device), and is secured to prevent the load from shifting [Figure 116].

Operate the controls slowly and smoothly to avoid suddenly swinging the lifted load.

Lift and position the load. When the load is placed in a secured position and tension is removed from the lift chain, remove the chain from the load and from the lift eye.

OPERATING PROCEDURE (CONT'D)

Lift Capacity

The lifting capacities were calculated with a Standard Configuration Machine (machine equipped with a pin-on interface and no attachment). The weight of the attachment, hydraulic clamp (if equipped) and different interface must be subtracted from the lift capacity, to obtain the actual lift capacity.



AVOID INJURY OR DEATH

Do not exceed rated lift capacity. Excessive load can cause tipping or loss of control.

W-2374-0500

Figure 117

A	B			B			B			B		
	2000 mm (79 in)	3000 mm (118 in)	@ max. B	2000 mm (79 in)	3000 mm (118 in)	@ max. B	2000 mm (79 in)	3000 mm (118 in)	@ max. B	2000 mm (79 in)	3000 mm (118 in)	@ max. B
	2000 mm (79 in)			*336 kg @ 2960 mm (740 lb @ 117 in)			258 kg @ 2960 mm (569 lb @ 117 in)			304 kg @ 2960 mm (671 lb @ 117 in)		
1000 mm (39 in)	*448 kg (988 lb)	*352 kg (776 lb)	*330 kg @ 3338 mm (728 lb @ 131 in)	*448 kg (988 lb)	246 kg (542 lb)	246 kg @ 3338 mm (462 lb @ 131 in)	*448 kg (988 lb)	289 kg (637 lb)	246 kg @ 3338 mm (542 lb @ 131 in)	313 kg (689 lb)	170 kg (375 lb)	143 kg @ 3338 mm (315 lb @ 131 in)
Ground	*694 kg (1529 lb)	*773 kg (1703 lb)	*306 kg @ 3310 mm (674 lb @ 130 in)	409 kg (901 lb)	236 kg (521 lb)	207 kg @ 3310 mm (456 lb @ 130 in)	484 kg (1068 lb)	276 kg (608 lb)	241 kg @ 3310 mm (530 lb @ 130 in)	276 kg (608 lb)	160 kg (354 lb)	136 kg @ 3310 mm (300 lb @ 130 in)
-1000 mm (-39 in)			*309 kg @ 2875 mm (681 lb @ 113 in)	415 kg (916 lb)		247 kg @ 2875 mm (544 lb @ 113 in)	485 kg (1069 lb)		286 kg @ 2875 mm (631 lb @ 113 in)	270 kg (596 lb)		168 kg @ 2875 mm (371 lb @ 113 in)

*** 352 kg
(776 lb)**

91389 SW 7255509
7255509

Detailed information about Quick Coupler and hydraulic clamp weights can be found in documentation including its serial number plates. The following lists examples of the optional quick couplers and hydraulic clamp weights:

- Lehnhoff® Quick Coupler (BQC) Type SW = 18 kg (40 lb)
- Klac™ Quick Coupler (BQC) Type K = 16 kg (35 lb)
- Hydraulic Clamp And Cylinder = 32 kg (71 lb)
- Optional Buckets and Attachments (See **NOTE** below)

NOTE: For bucket weights, see your Bobcat dealer. For attachment weights, see the attachment Operation & Maintenance Manual.

The following example will show how to calculate the lift capacity differences between the lift capacity charts with standard equipment and when using optional equipment.



OPERATING PROCEDURE (CONT'D)

Lift Capacity (Cont'd)

The following is an example for determining the actual lift capacity using the sample chart shown above **[Figure 117]**.

- Machine Position: Over Blade, Tracks Expanded, Blade Down
- Lift Radius: 3000 mm (118 in)
- Lift Point Height: 1000 mm (39 in)
- Hydraulic Clamp and Cylinder
- Standard Bucket

1. Obtain Lift Capacity from Chart: 352 kg (776 lb)

2. Obtain the weights of optional equipments which reduce the lift capacity of the machine (coupling interface, hydraulic clamp, attachment).

Optional Equipment Weights: Standard Bucket 42 kg (92 lb), attachment coupler system 18 kg (40 lb), Hydraulic Clamp and Cylinder: 32 kg (71 lb)

3. Calculate the actual lift capacity by subtracting the weight of optional equipments from the lift capacity of standard configuration.

352 kg (776 lb) - 42 kg (92 lb) (standard bucket) - 18 kg (40 lb) (attachment coupler system) - 32 kg (71 lb) (hydraulic clamp and cylinder) = 260 kg (573 lb)

** The lift capacity charts (decals) are based off of ISO 10567: 2007. The lifting capacities are defined as the lower value of 75% of tipping load or 87% of the hydraulic lift capacity.*

OPERATING PROCEDURE (CONT'D)

Using The Clamp

Figure 118

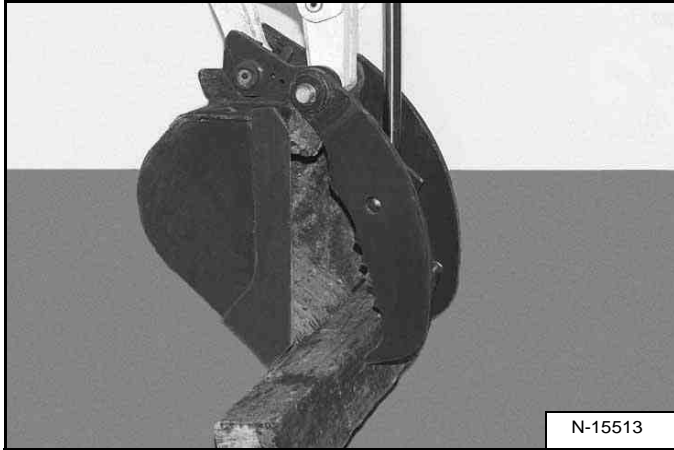

The optional lifting clamp attachment gives the excavator a wider range of use and mobility for debris removal [Figure 118].

The lifting clamp cylinder must be fully retracted when the machine is being used for excavating.

The lift capacities are reduced by 32 kg (71 lb) if the excavator is equipped with the optional lifting clamp.

Using Right Joystick Switch To Activate Clamp

Engage auxiliary hydraulics. (See Auxiliary Hydraulics - Joystick Controls on Page 53.)

Figure 119



If equipped with the switch in the right joystick, move the switch (Item 1) [Figure 119] to the right to open the clamp. Move the switch to the left to close the clamp.

Using Auxiliary Hydraulic Pedal To Activate Clamp

Figure 120

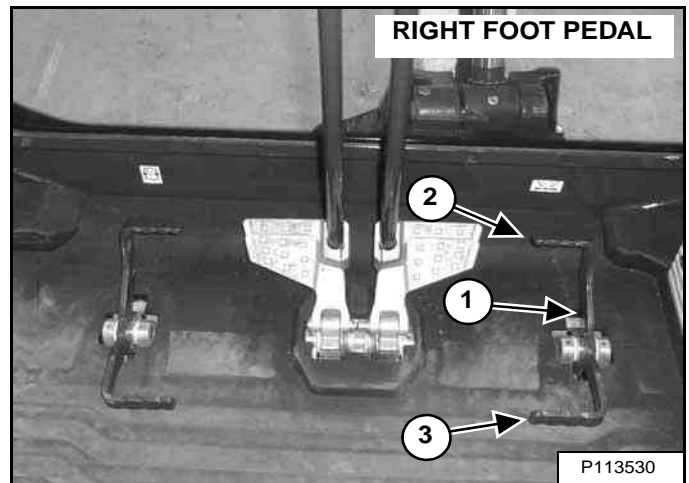

If equipped, the auxiliary hydraulic pedal (Item 1), controls the hydraulic clamp. Press the toe (Item 2) of the auxiliary hydraulic pedal to open the clamp. Press the heel (Item 3) [Figure 120] of the pedal to close the clamp.

OPERATING PROCEDURE (CONT'D)

Excavating

Expand the tracks fully. (See TRACK FRAME RETRACTION - EXPANSION on Page 56.)

Lower the blade to increase digging performance.

Figure 121

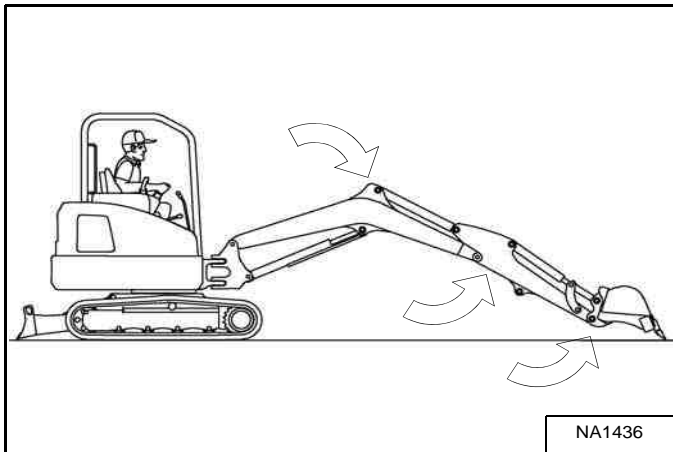

Extend the arm, lower the boom, and open the bucket [Figure 121].

Figure 122

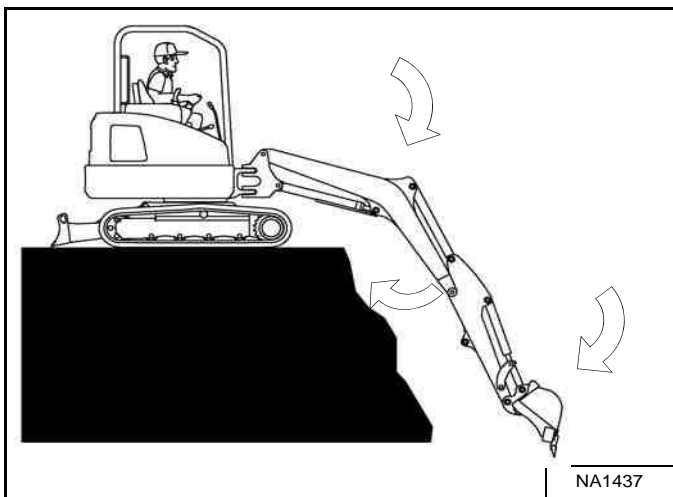

Retract the arm, while lowering boom and curling the bucket [Figure 122].

Figure 123

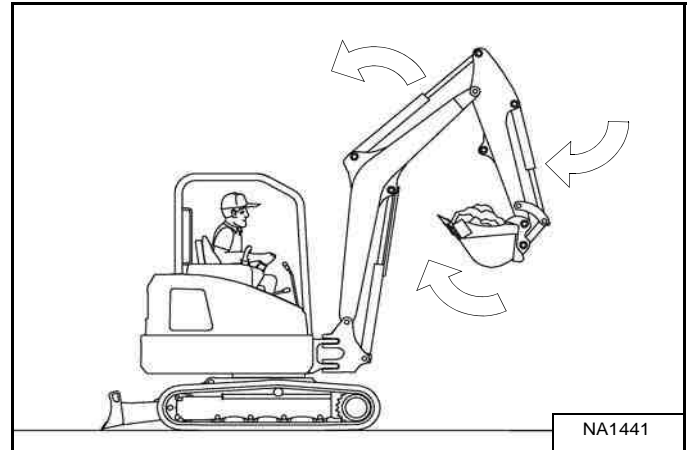

Raise the boom, retract the arm and curl the bucket [Figure 123].

Rotate the upperstructure.

NOTE: Do not allow the bucket teeth to contact the ground when slewing the upperstructure.

! WARNING

Keep all bystanders 6 m (20 ft) away from equipment when operating. Contact with moving parts, a trench cave-in or flying objects can cause injury or death.

W-2119-0910

! WARNING

AVOID INJURY OR DEATH

Check area to be excavated for overhead or underground electrical power lines. Keep a safe distance from electrical power lines.

VOLTAGE	MINIMUM DISTANCE
up to 50 kV	3 m (10 ft)
beyond 50 kV	5 m (17 ft)

W-2757-EN-0513

OPERATING PROCEDURE (CONT'D)

Excavating (Cont'd)

Figure 124

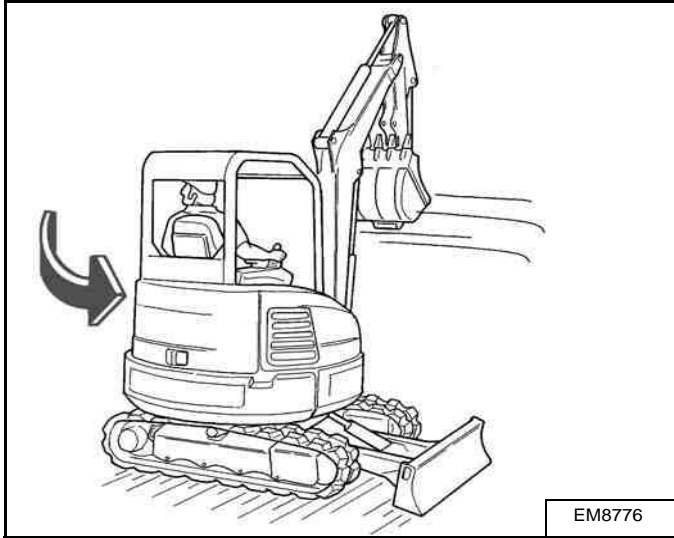

Look in the direction of rotation and make sure there are no bystanders in the work area before rotating the upperstructure [Figure 124].

Figure 125

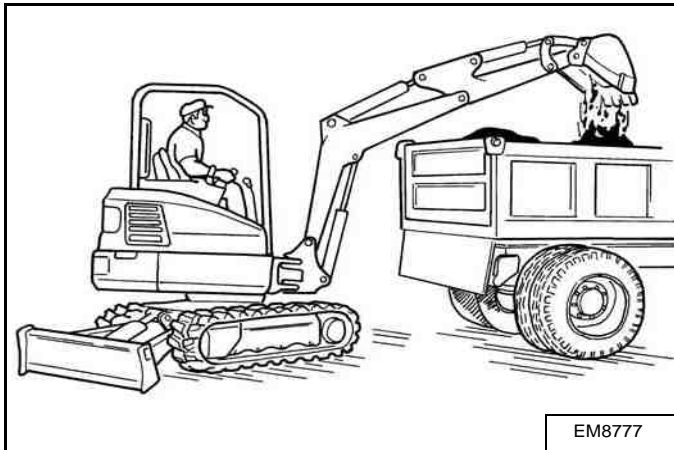

Extend the arm and uncurl the bucket to dump the material into a pile or truck [Figure 125].

IMPORTANT

Avoid operating hydraulics over relief pressure. Failure to do so will overheat hydraulic components.

I-2220-0503

Figure 126

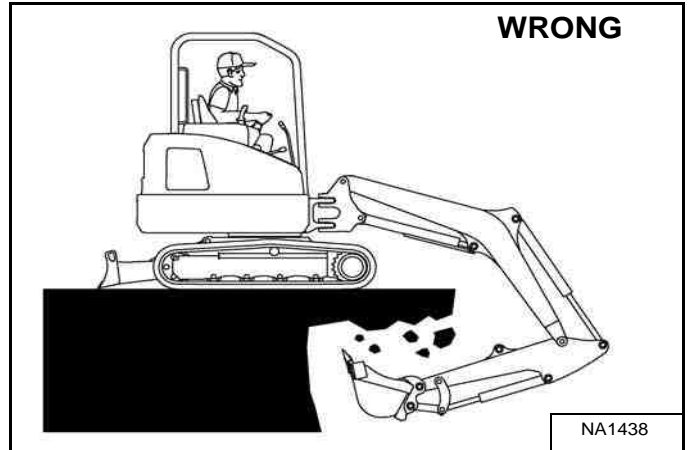

Do not dig under the excavator [Figure 126].

Do not use the bucket as a breaker or pile driver. It is better to excavate hard or rocky ground after breaking it with other equipment. This will reduce damage to the excavator.

Do not move the excavator while the bucket is in the ground.

Dig only by moving the boom and arm toward the excavator.

Do not back dig (digging by moving the boom and arm away from the excavator). Damage to the quick coupler and attachments can occur.

OPERATING PROCEDURE (CONT'D)

Boom Swing

Figure 127

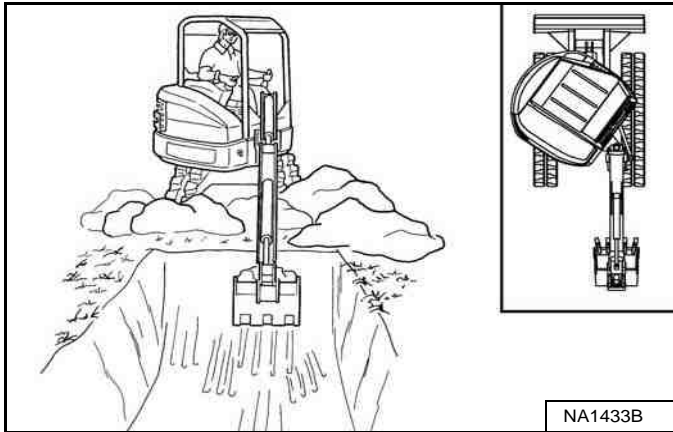

Figure 128

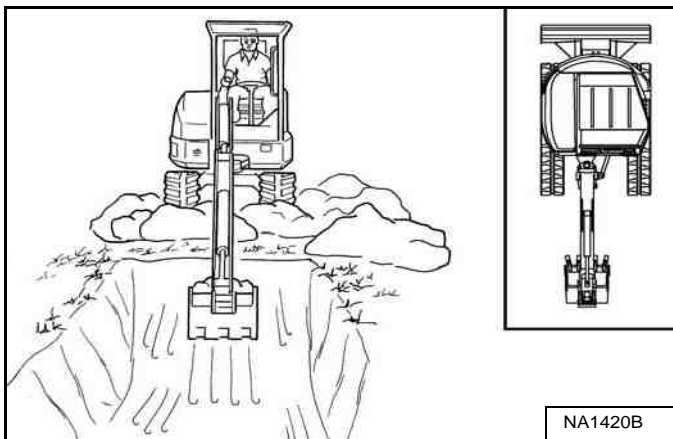
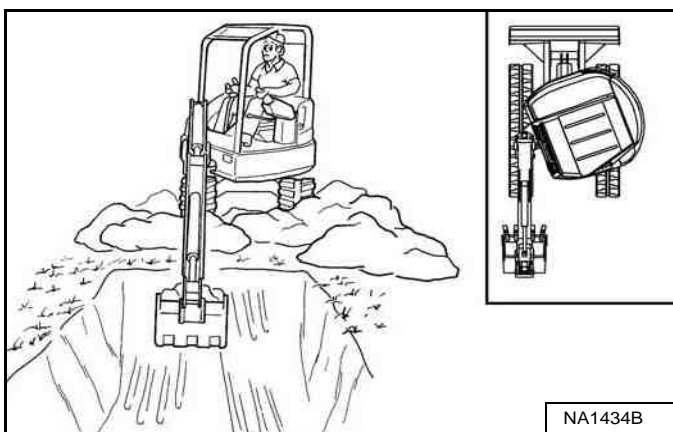

Figure 129



Slew the upperstructure, swing the boom to the right [Figure 127], centre [Figure 128] and left [Figure 129] to dig a square hole the width of the machine without repositioning the excavator.

Figure 130



The boom swing allows the operator to offset the boom and dig close to buildings and other structures [Figure 130].

OPERATING PROCEDURE (CONT'D)

Backfilling

IMPORTANT

Avoid impacting objects with the blade. Damage to blade and undercarriage components may occur.

I-2256-0507

Figure 131

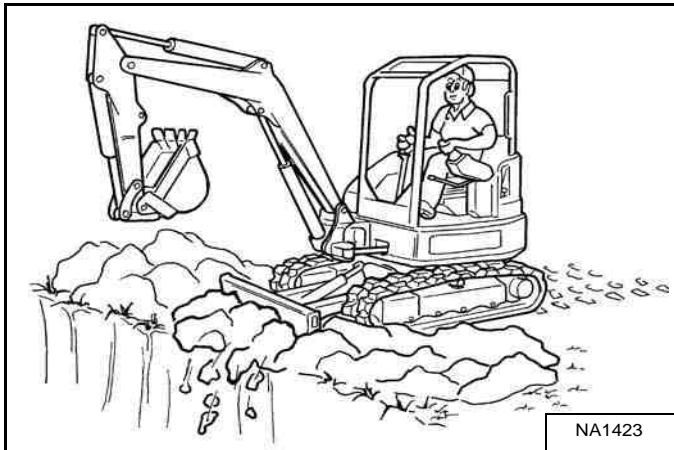

Use the blade to backfill the trench or hole after excavating [Figure 131].

Driving The Excavator

When operating on uneven ground, operate as slow as possible and avoid sudden changes in direction.

Avoid travelling over objects such as rocks, trees, stumps, etc.

When working on wet or soft ground, put planks on the ground to provide a solid base to travel on and prevent the excavator from getting stuck.

Figure 132

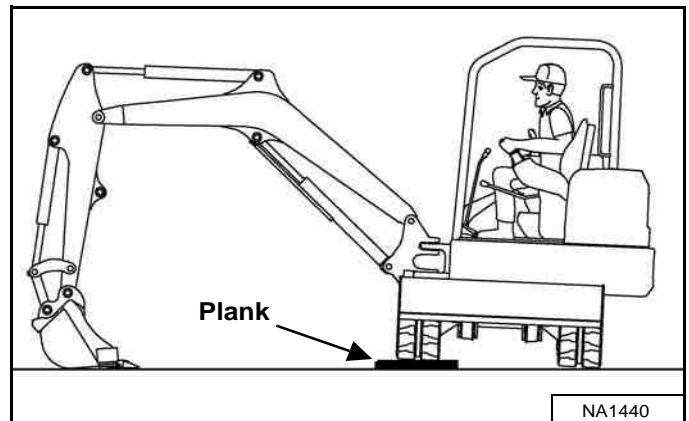

If one or both tracks have become stuck in soft or wet ground, raise one track at a time by turning the upperstructure and pushing the bucket against the ground [Figure 132].

Put planks under the tracks and drive the excavator to dry ground.

Figure 133

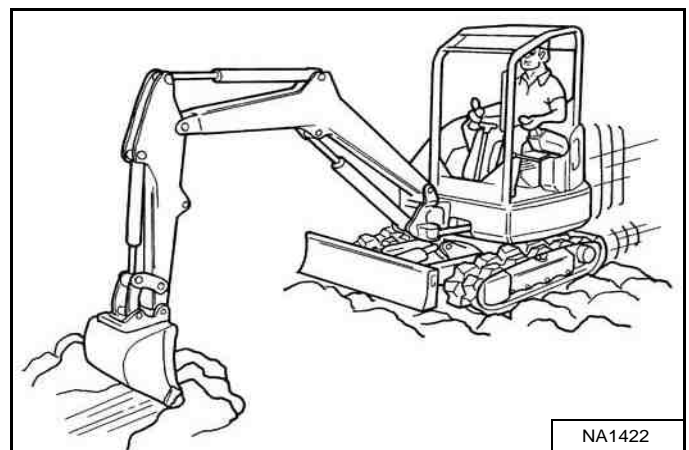

The bucket can also be used to pull the excavator. Raise the blade, extend the arm and lower the boom. Operate the boom and arm in a digging manner [Figure 133].

OPERATING PROCEDURE (CONT'D)

Operating On Slopes



AVOID INJURY OR DEATH

- Do not travel across or up slopes that are over 15 degrees.
- Do not travel down or back up slopes that exceed 25 degrees.
- Look in the direction of travel.

W-2497-0304

When going down a slope, control the speed with the steering levers and the speed control dial gauge.

Figure 134

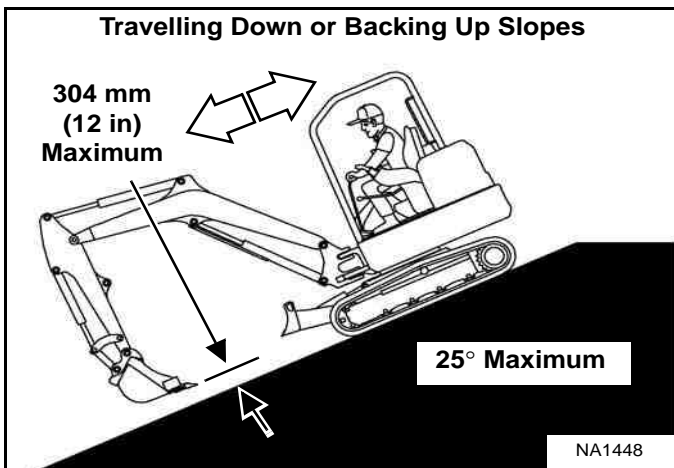

When going down grades that exceed 15 degrees, put the machine in the position shown, and run the engine slowly [Figure 134].

Operate as slow as possible and avoid sudden changes in lever direction.

Avoid travelling over objects such as rocks, trees, stumps, etc.

Stop the machine before moving the upper equipment controls. Never allow the blade to strike a solid object. Damage to the blade or hydraulic cylinder can result.



AVOID INJURY OR DEATH

- Avoid steep areas or banks that could break away.
- Keep boom centred and attachments as low as possible when travelling on slopes or in rough conditions. Look in the direction of travel.
- Always fasten seat belt.

W-2498-EN-1009

Figure 135

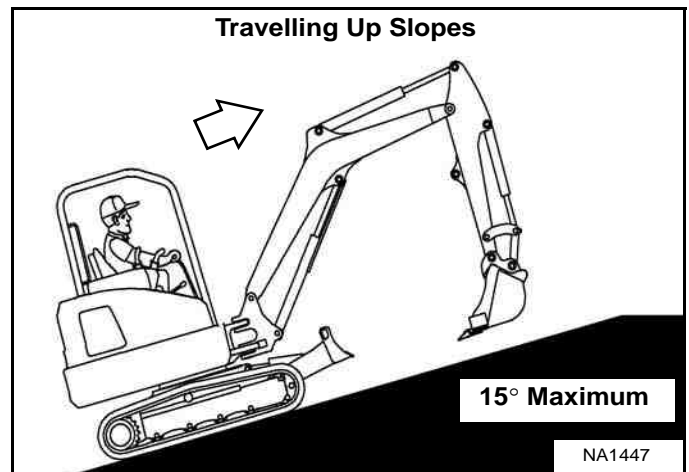
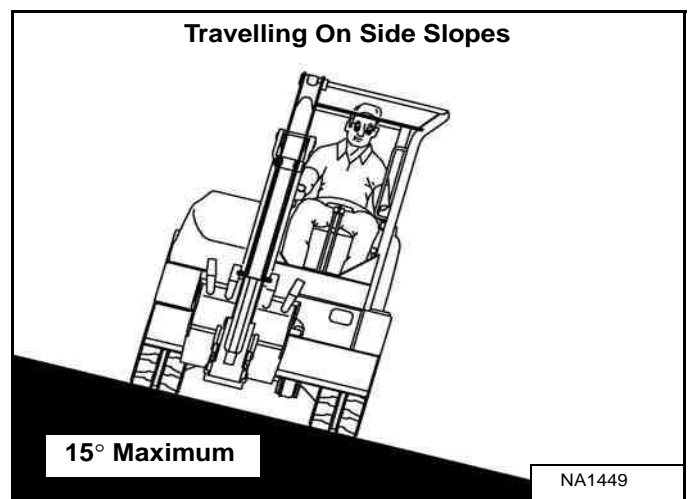

Figure 136



When travelling up slopes or on side slopes that are 15 degrees or less, position the machine as shown and run the engine slow [Figure 135] and [Figure 136].

OPERATING PROCEDURE (CONT'D)

Operating On Slopes (Cont'd)

Figure 137

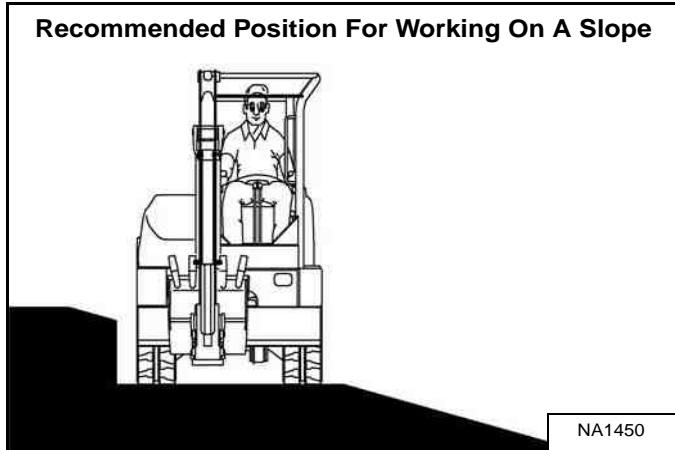

When operating on a slope, level the work area before beginning [Figure 137].

If this is not possible, the following procedures should be used:

Do not work on slopes which are over 15 degrees.

Use a slow work cycle.

Avoid working with the tracks across the slope. This will reduce stability and increase the tendency for the machine to slide. Position the excavator with the blade downhill and lowered.

Avoid swinging or extending the bucket more than necessary in a down hill direction. When you must swing the bucket downhill, keep the arm low and skid the bucket downhill.

When working with the bucket on the uphill side, keep the bucket as close to the ground as possible. Dump the spoil far enough away from the trench or hole to prevent the possibility of a cave in.

Figure 138

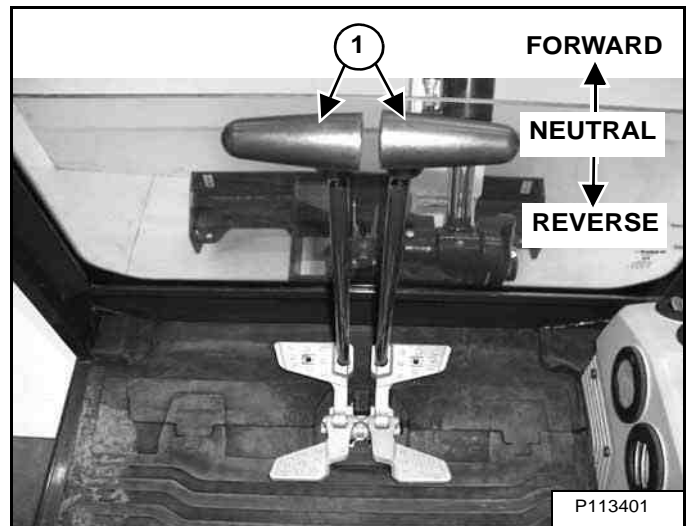

To brake the machine when going down a slope, move the steering levers (Item 1) [Figure 138] to the NEUTRAL position. This will engage the hydrostatic braking.

When the engine stops on a slope, move the steering levers to the NEUTRAL position. Lower the boom / bucket to the ground.

NOTE: If the engine stops, the boom / bucket (attachments) can be lowered to the ground using hydraulic pressure which is stored in the accumulator.

The console must be in the locked down position, and the key switch in the ON position.

Use the control lever to lower the boom.

Start the engine and resume operation.

OPERATING PROCEDURE (CONT'D)

Operating In Water

Mud and water should be removed from the machine before parking. In freezing temperatures, park the machine on boards or concrete to prevent the track or undercarriage from freezing to the ground and preventing machine movement.

Figure 139

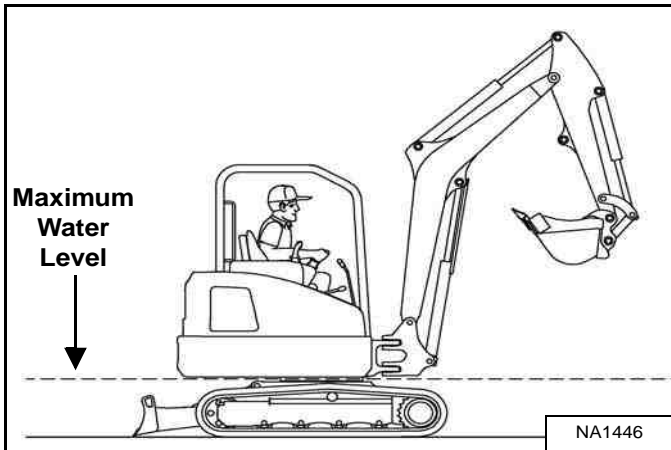

Do not operate or immerse the excavator in water higher than the bottom of the slew bearing **[Figure 139]**.

Grease the excavator when it has been operated or immersed in water for a period of time. Greasing forces the water out of the lubrication areas.

Water must be removed from the cylinder rods. If water freezes to the cylinder rod, the cylinder seals can be damaged when the rod is retracted.

OPERATING PROCEDURE (CONT'D)

Avoiding Track Damage

Mud and water should be removed from the machine before parking. In freezing temperatures, park the machine on boards or concrete to prevent the track or undercarriage from freezing to the ground and preventing machine movement.

Some Causes Of Track Damage:

Figure 140

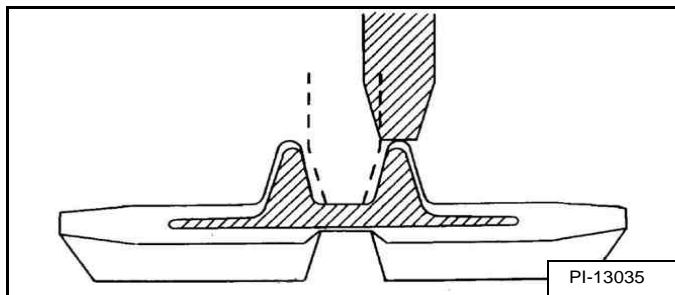

Incorrect track tension: When the rubber track is detracting, the idler or sprocket rides on the projections of the embedded metal **[Figure 140]** causing the embedded metal to be exposed to corrosion. (See TRACK TENSION on Page 134.)

If rubber track is clogged with stones or foreign objects, these can get wedged between the sprocket / rollers and cause detracting and track stress.

When moisture invades through cuts on the track, the embedded steel cords will corrode. The deterioration of the design strength can lead to the breaking of the steel cords.

Figure 141

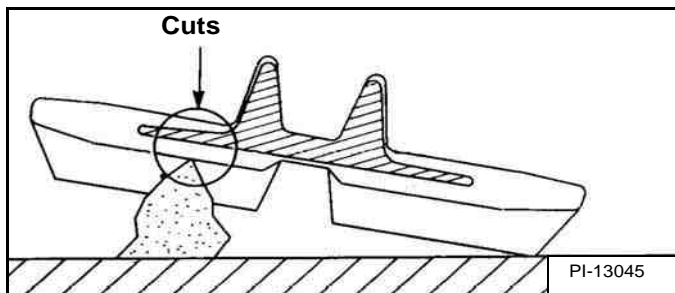

When rubber tracks drive over projections or sharp objects in the field, the concentrated forces applied cause cuts on the lug side rubber surface **[Figure 141]**. In case of making turns on projections, the lug side rubber surface will have an even higher chance to be cut. If the cuts run through the embedded steel cords, it might result in the steel cords' breakage due to their corrosion.

Avoid quick turns on bumpy and rocky fields.

Driving over sharp objects should be avoided. If this is impossible, do not make turns while driving over sharp objects.

Figure 142

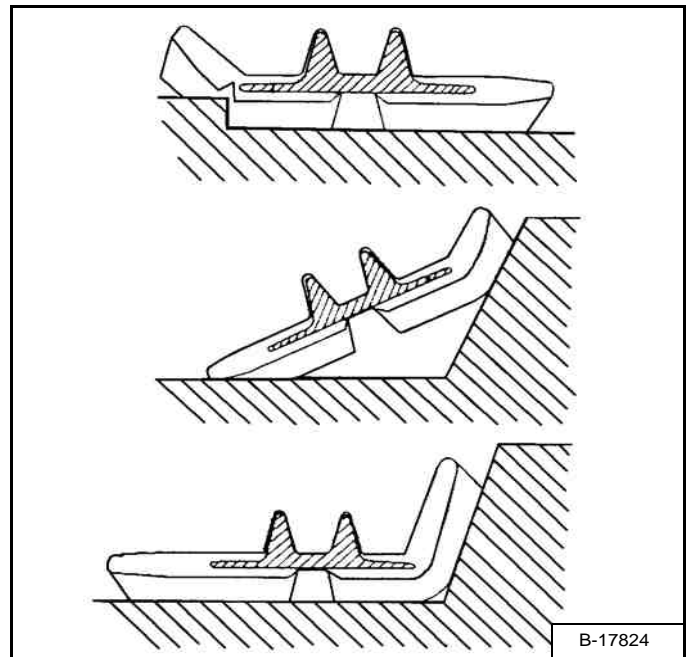

When rubber tracks drive over sharp projections, intensive stress is applied to the lug side rubber surface, especially at the edges of embedded metals, causing cracks and cuts in the area around the embedded metals **[Figure 142]**.

Avoid extensive stress applied to the lug root where metals are embedded. Operators should try to avoid driving over stumps and ridges.



TOWING THE EXCAVATOR

Procedure

There is not a recommended towing procedure for the excavators.

- The excavator can be lifted onto the transport vehicle.
- The excavator can be skidded a short distance for service (EXAMPLE: Move onto a transport vehicle) without damage to the hydraulic system. (The tracks will not turn.) There might be slight wear to the tracks when the excavator is skidded.
- The towing chain (or cable) must be rated at 1.5 times the weight of the excavator. (See Performance on Page 161.)

LIFTING THE EXCAVATOR

Procedure

Figure 143

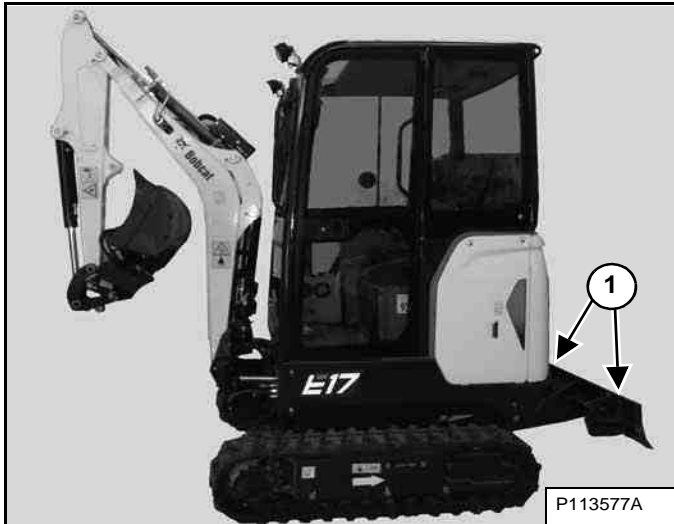

Fully extend the cylinders of the bucket, arm, and boom so that the excavator is in the position as shown [Figure 143].

Raise the blade all the way.

Put all the control levers in NEUTRAL.

WARNING

AVOID INJURY OR DEATH

- Use chains and lifting equipment with sufficient capacity for the weight of the excavator plus any added attachments.
- Maintain centre of gravity and balance when lifting.
- Do not swing boom or upperstructure.
- Never lift with operator on machine.
- Never lift with the blade angled (if equipped).

W-2800-EN-0210

Figure 144

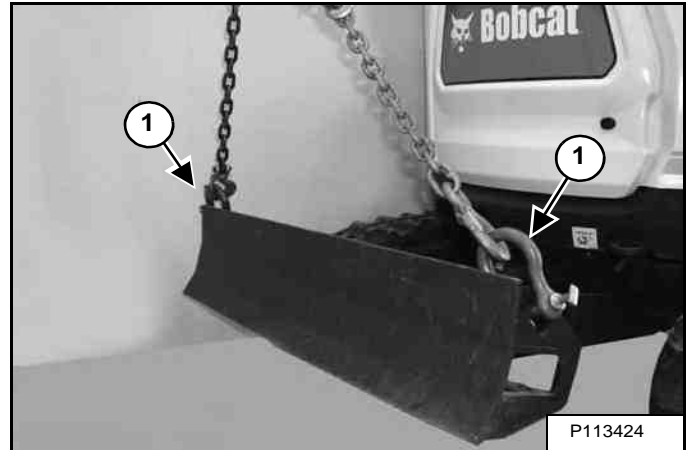
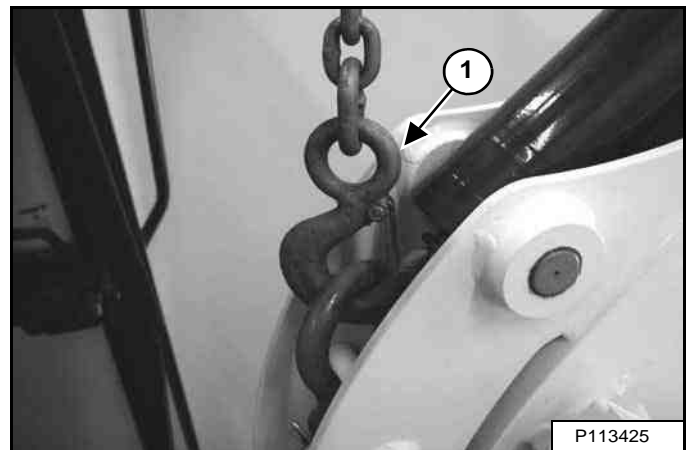

Figure 145



Fasten chains to the ends of the blade (Item 1) [Figure 143] and [Figure 144] and up to a lifting fixture above the canopy / cab. The lifting fixture must extend over the sides of the canopy / cab to prevent the chains from hitting the ROPS / TOPS.

Fasten a chain (Item 1) [Figure 145] from the rod to the lift fixture.

NOTE: Depending on the type of chain hooks, it may be necessary to install a clevis at the lift points and then hook to the clevis.

TRANSPORTING THE EXCAVATOR ON A TRAILER

Loading And Unloading

When transporting the machine, observe the rules, motor vehicle laws, and vehicle limit ordinances. Use a transport and towing vehicle of adequate length and capacity.

Secure the parking brakes and block the wheels of the transport vehicle.

Align the ramps with the centre of the transport vehicle. Secure the ramps to the truck bed and be sure ramp angle does not exceed 15 degrees.

Use metal loading ramps with a slip resistant surface.

Use ramps that are the correct length and width and can support the weight of the machine.

The rear of the trailer must be blocked or supported when loading or unloading the machine to prevent the front of the transport vehicle from raising.

Determine the direction of the track movement before moving the machine (blade forward).

Disengage the auto idle feature and move the two speed travel to the low range position.

Figure 146



Move the machine forward onto the transport vehicle [Figure 146].

Do not change direction of the machine while it is on the ramps.

Lower the boom, arm, bucket, and blade to the transport vehicle.

Stop the engine and remove the key (if equipped).

Put blocks at the front and rear of the tracks.

Fastening

Figure 147

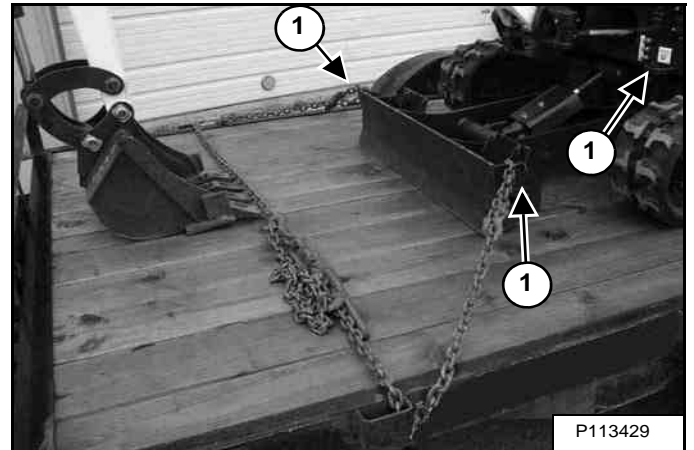
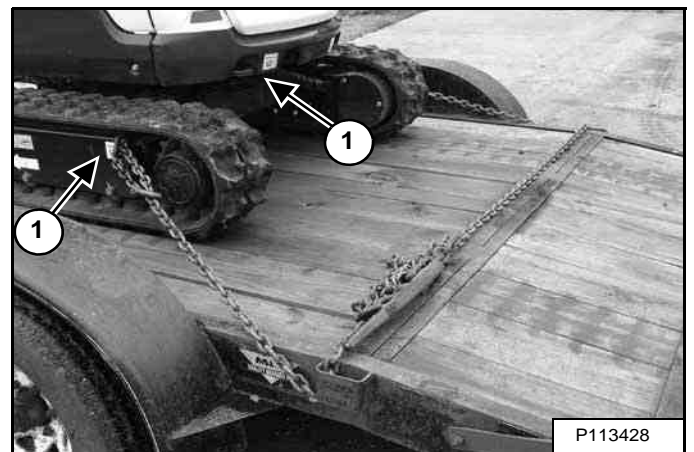

Figure 148



Fasten chains to the front corners of the blade (Item 1) [Figure 147] (or the front corner of the upperstructure) and to the tie down loop at both sides of the track frame (Item 1) [Figure 148] (or the tie down on the rear of the upperstructure) to prevent it from moving when going up or down slopes or during sudden stops.

Use chain binders to tighten the chains and then safely tie the chain binder levers to prevent loosening.



AVOID SERIOUS INJURY OR DEATH
Adequately designed ramps of sufficient strength are needed to support the weight of the machine when loading onto a transport vehicle. Wood ramps can break and cause personal injury.

W-2058-0807



Bobcat®



PREVENTIVE MAINTENANCE

MAINTENANCE SAFETY	101
SERVICE SCHEDULE	103
Maintenance Intervals	103
CONTROL CONSOLE LOCKOUTS	105
Inspection And Maintenance	105
SEAT BELT	106
Inspection And Maintenance	106
MOTION ALARM SYSTEM	107
Description	107
Inspecting	107
Adjusting Switch Position	108
TAILGATE	109
Opening And Closing	109
Adjusting The Latch	109
RIGHT SIDE COVER	110
Opening And Closing	110
CAB FILTERS	111
Cleaning And Maintenance	111
AIR CLEANER SERVICE	112
Daily Check	112
Replacing The Filter Elements	112
FUEL SYSTEM	114
Fuel Specifications	114
Biodiesel Blend Fuel	114
Filling The Fuel Tank	115
Fuel Filter	116
Draining The Fuel Tank	116
Removing Air From The Fuel System	117
ENGINE LUBRICATION SYSTEM	118
Checking And Adding Engine Oil	118
Engine Oil Chart	118
Removing And Replacing Oil And Filter	119
ENGINE COOLING SYSTEM	120
Cleaning	120
Checking Level	121
Removing And Replacing Coolant	122



ELECTRICAL SYSTEM	123
Description	123
Fuse And Relay Location / Identification	123
Battery Disconnect Switch	125
Battery Maintenance	126
Using A Booster Battery (Jump Starting)	126
Removing And Installing The Battery	128
HYDRAULIC SYSTEM	129
Checking And Adding Hydraulic Fluid	129
Hydraulic / Hydrostatic Fluid Chart	130
Removing And Replacing The Hydraulic Filters	130
Removing And Replacing The Hydraulic Fluid	131
SPARK ARRESTOR MUFFLER	132
Cleaning Procedure	132
TRACK TENSION	134
Checking Tension	134
Adjusting Tension	135
TRAVEL MOTOR	136
Checking And Adding Oil	136
Removing And Replacing Oil	136
ALTERNATOR AND FAN BELT	137
Belt Adjustment	137
Belt Replacement	137
QUICK COUPLER	138
Bucket Link And Attachment Coupler Inspection And Maintenance	138
TRACK ROLLER AND IDLER LUBRICATION	138
Procedure	138
LUBRICATION OF THE HYDRAULIC EXCAVATOR	139
Lubrication Locations	139
PIVOT PINS	142
Inspection And Maintenance	142
EXCAVATOR STORAGE AND RETURN TO SERVICE	143
Storage	143
Return To Service	143

MAINTENANCE SAFETY

WARNING

Instructions are necessary before operating or servicing machine. Read and understand the Operation & Maintenance Manual, Operator's Handbook and signs (decals) on machine. Follow warnings and instructions in the manuals when making repairs, adjustments or servicing. Check for correct function after adjustments, repairs or service. Untrained operators and failure to follow instructions can cause injury or death.

W-2003-0807

Safety Alert Symbol: This symbol with a warning statement, means: "Warning, be alert! Your safety is involved!" Carefully read the message that follows.

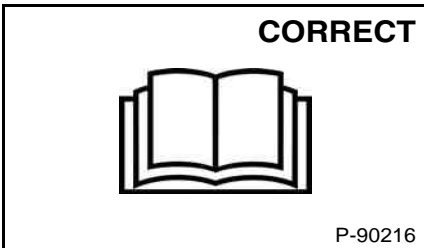

Never service the Bobcat Compact Excavator without instructions.

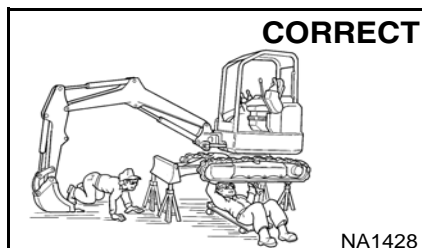

Use the correct procedure to lift and support the excavator.

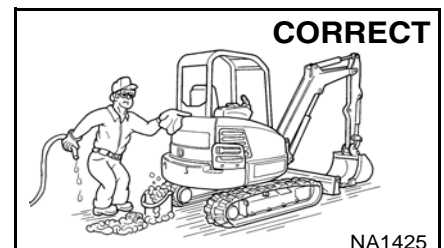

Cleaning and maintenance are required daily.

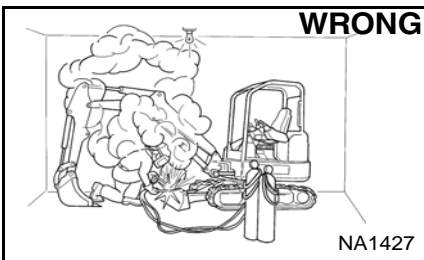

Have good ventilation when welding or grinding painted parts.
 Wear dust mask when grinding painted parts. Toxic dust and gas can be produced.

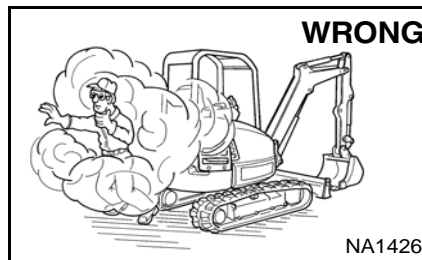

Vent exhaust to outside when engine must be run for service.
 Exhaust system must be tightly sealed. Exhaust fumes can kill without warning.

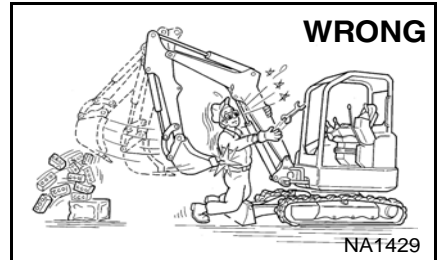

Always lower the bucket and blade to the ground before doing any maintenance.
 Never modify equipment or add attachments not approved by Bobcat Company.

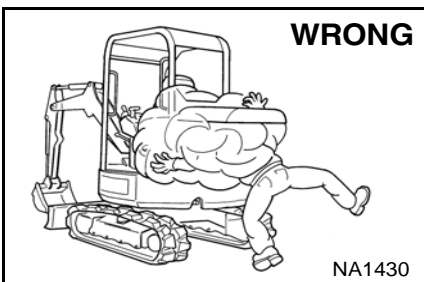

Stop, cool and clean engine of flammable materials before checking fluids.
 Never service or adjust machine with the engine running unless instructed to do so in the manual.
 Avoid contact with leaking hydraulic fluid or diesel fuel under pressure. It can penetrate the skin or eyes.
 Never fill fuel tank with engine running, while smoking, or when near open flame.

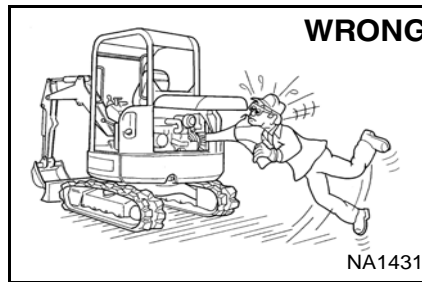

Keep body, jewelry and clothing away from moving parts, electrical contact, hot parts and exhaust.
 Wear eye protection to guard from battery acid, compressed springs, fluids under pressure and flying debris when engines are running or tools are used. Use eye protections approved for type of welding.
 Keep tailgate closed except for service. Close and latch tailgate before operating the excavator.

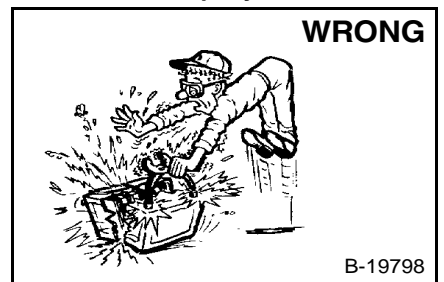

Lead-acid batteries produce flammable and explosive gases.
 Keep arcs, sparks, flames and lighted tobacco away from batteries.
 Batteries contain acid which burns eyes or skin on contact.
 Wear protective clothing. If acid contacts body, flush well with water. For eye contact flush well and get immediate medical attention.

Maintenance procedures which are given in the Operation & Maintenance Manual can be performed by the owner / operator without any specific technical training. Maintenance procedures which are **not** in the Operation & Maintenance Manual must be performed **ONLY BY QUALIFIED BOBCAT SERVICE PERSONNEL**. Always use genuine Bobcat replacement parts. The Service Safety Training Course is available from your Bobcat dealer.

MSW38-0409



Bobcat®



SERVICE SCHEDULE

Maintenance Intervals

Maintenance work must be done at regular intervals. Failure to do so will result in excessive wear and early failures.

The service schedule is a guide for correct maintenance of the Bobcat excavator.

WARNING

AVOID INJURY OR DEATH

Instructions are necessary before operating or servicing machine. Read and understand the **Operation & Maintenance Manual, Operator's Handbook** and signs (decals) on machine. Follow warnings and instructions in the manuals when making repairs, adjustments or servicing. Check for correct function after adjustments, repairs or service. Untrained operators and failure to follow instructions can cause injury or death.

W-2003-0807

Every 10 Hours (Before Starting The Excavator)

- **Engine Oil** - Check level and add as needed.
- **Engine Air Filters and Air System** - Check air clearer condition indicator. Service only when required. Check for leaks and damaged components.
- **Engine Cooling System** - Check coolant level COLD and add premixed coolant as needed.
- **Fuel Filters**- Check filters for moisture or contamination. Drain and replace as needed.
- **Hydraulic Fluid** - Check fluid level and add as needed.
- **Seat Belt, Seat Belt Retractors, Seat Belt Mounting hardware, Control Console Lockout** - Check the condition of seat belt and mounting hardware. Clean or replace seat belt retractors as needed. Check the control console lockout lever for proper operation. Clean dirt and debris from moving parts.
- **Motion Alarm** - Check for proper function.
- **Operator Cab** - Check the cab condition and mounting hardware.
- **Cab Heater Filters** - Clean filters (if equipped).
- **Indicators and Lights** - Check for correct operation of all indicators and lights.
- **Safety Signs** - Check for damaged signs (decals). Replace any signs that are damaged.
- **Console Lockout** - Check console lockout for proper operation.
- **Track Tension** - Check tension and adjust as needed.
- **Pivot Points** - Grease all machinery pivot points. Grease track expansion. Grease clamp (if equipped).
- **Attachment Coupler** - Check for damage or loose parts (if equipped).

Every 50 Hours

- **Swing Bearing** - Grease swing bearing and swing pinion. Service every 10 hours when operating in water.
- **Battery** - Check cables, connections, and electrolyte level; add distilled water as needed.
- **Fuel Tank** - Drain water and sediment from fuel tank and fuel filter.
- **Drive Belts (Alternator)** - Service at first 50 hours, then as scheduled.
- **Engine Oil and Filter** - Service at first 50 hours, then as scheduled. Replace oil and filter.

SS EXC E17-0416



SERVICE SCHEDULE (CONT'D)

Maintenance Intervals (Cont'd)

Every 100 Hours

- **Spark Arrester** - Empty spark chamber.
- **Hydraulic Filter and Hydraulic Reservoir Breather Cap** - Replace the hydraulic filter and the reservoir breather cap.
- **Alternator and Starter** - Check connections.
- **Travel Motors (Final Drive)** - Service at first 100 hours, then as scheduled. Replace fluid.

Every 250 Hours Or Every 12 Months

- **Fuel Filter** - Replace fuel filter.
- **Travel Motors (Final Drive)** - Check fluid level and add as needed.
- **Drive Belts (Alternator)** - Check condition. Replace as needed, then as scheduled.

Every 500 Hours Or Every 12 Months

- **Engine Oil and Filter** - Replace oil and filter.
- **Cooling System** - Clean debris from radiator / hydraulic fluid cooler.
- **Hydraulic Filter and Hydraulic Reservoir Breather Cap** - Replace the hydraulic filter and the reservoir breather cap.
- **Alternator and Starter** - Check connections.
- **Heater** - Clean housing and coils (if equipped).

Every 1000 Hours Or Every 12 Months

- **Hydraulic Fluid and Filters** - Replace hydraulic fluid and filters.
- **Engine Valves** - Adjust the engine valve clearance.
- **Travel Motors (Final Drive)** - Replace fluid.

Every 24 Months

- **Coolant** - Replace the coolant.

SS EXC E17-0416

CONTROL CONSOLE LOCKOUTS

Inspection And Maintenance

Figure 149

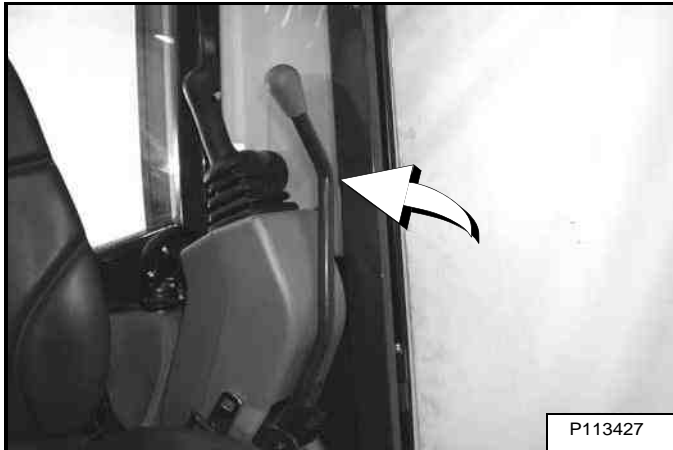

When the left console is raised **[Figure 149]**, the hydraulic control levers (joysticks) and traction system must not function.

Sit in the operator's seat, fasten the seat belt and start the engine.

Raise the left console **[Figure 149]**.

Move the joystick control levers. There should be no movement of the boom, arm, slew or bucket.

Move the steering control levers. There should be no movement of the excavator tracks.

Service the system if these controls do not deactivate when the left control console is raised. (See your Bobcat dealer for service.)

SEAT BELT

Inspection And Maintenance

! WARNING

Failure to properly inspect and maintain the seat belt can cause lack of operator restraint resulting in serious injury or death.

W-2466-0703

Check the seat belt daily for correct function.

Inspect the seat belt system thoroughly at least once each year or more often if the machine is exposed to severe environmental conditions or applications.

Any seat belt system that shows cuts, fraying, extreme or unusual wear, significant discolourations due to ultraviolet UV exposure, dusty / dirty conditions, abrasion to the seat belt webbing, or damage to the buckle, latch plate, retractor (if equipped), hardware or any other obvious problem should be replaced immediately.

The items below are referenced in **[Figure 150]**.

1. Check the webbing. If the system is equipped with a retractor, pull the webbing completely out and inspect the full length of the webbing. Look for cuts, wear, fraying, dirt and stiffness.
2. Check the buckle and latch for correct operation. Make sure latch plate is not excessively worn, deformed or buckle is not damaged or casing broken.
3. Check the retractor web storage device (if equipped) by extending webbing to determine if it looks correct and that it spools out and retracts webbing correctly.
4. Check webbing in areas exposed to ultraviolet (UV) rays from the sun or extreme dust or dirt. If the original colour of the webbing in these areas is extremely faded and / or the webbing is packed with dirt, the webbing strength can have deteriorated.

See your Bobcat dealer for seat belt system replacement parts for your machine.

Figure 150

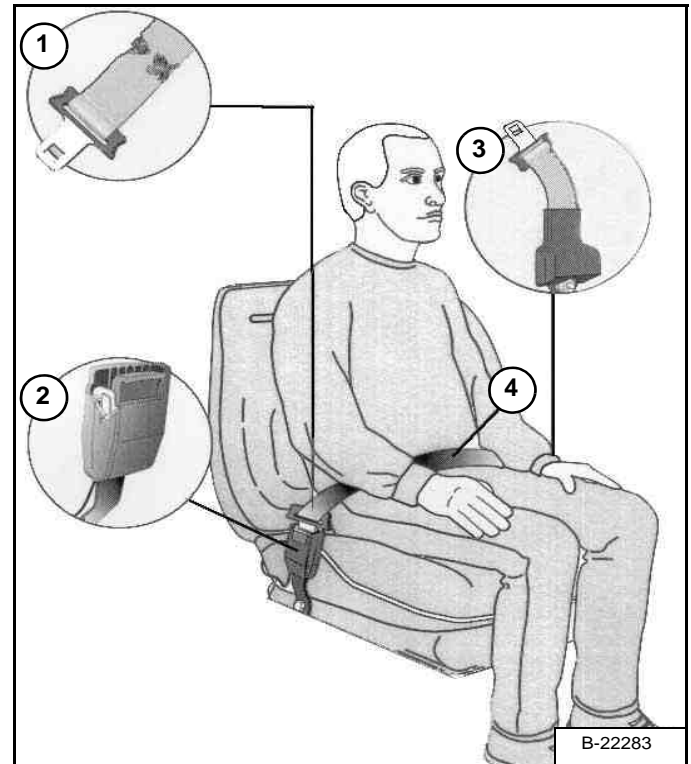

MOTION ALARM SYSTEM

Description

This excavator can be equipped with a motion alarm system. The motion alarm will sound when the operator moves the travel control levers in either the forward or reverse direction. Slight movement of the steering levers in either the forward or reverse direction is required with hydraulic components before the motion alarm will sound.

Inspecting

Figure 151



Figure 152

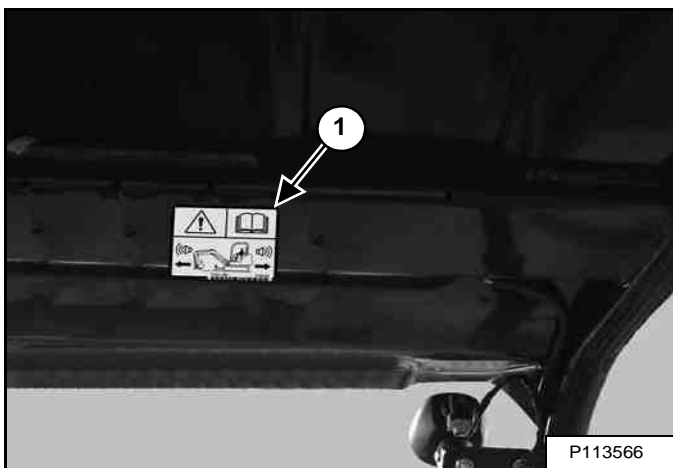

Inspect for damaged or missing motion alarm decal (Item 1) [Figure 151] (cab machine) or (Item 1) [Figure 152] (canopy machine). Replace if required.

NOTE: The excavator will need to be moved slightly in both the forward and reverse direction to test the motion alarm. Keep all bystanders away from machine during test.

WARNING

AVOID INJURY OR DEATH

When an engine is running in an enclosed area, fresh air must be added to avoid concentration of exhaust fumes. If the engine is stationary, vent the exhaust outside. Exhaust fumes contain odorless, invisible gases which can kill without warning.

W-2050-0807

Sit in the operator's seat and fasten the seat belt. Start the engine. (See PRE-STARTING PROCEDURE on Page 65.)

Move the travel control levers (one lever at a time) in the forward direction. The motion alarm must sound. Move the travel control levers (one lever at a time) in the reverse direction. The motion alarm must sound.

Return both levers to NEUTRAL and turn excavator key to OFF position. Exit the excavator. (See STOPPING THE ENGINE AND LEAVING THE EXCAVATOR on Page 72.)

MOTION ALARM SYSTEM (CONT'D)

Inspecting (Cont'd)

Figure 153

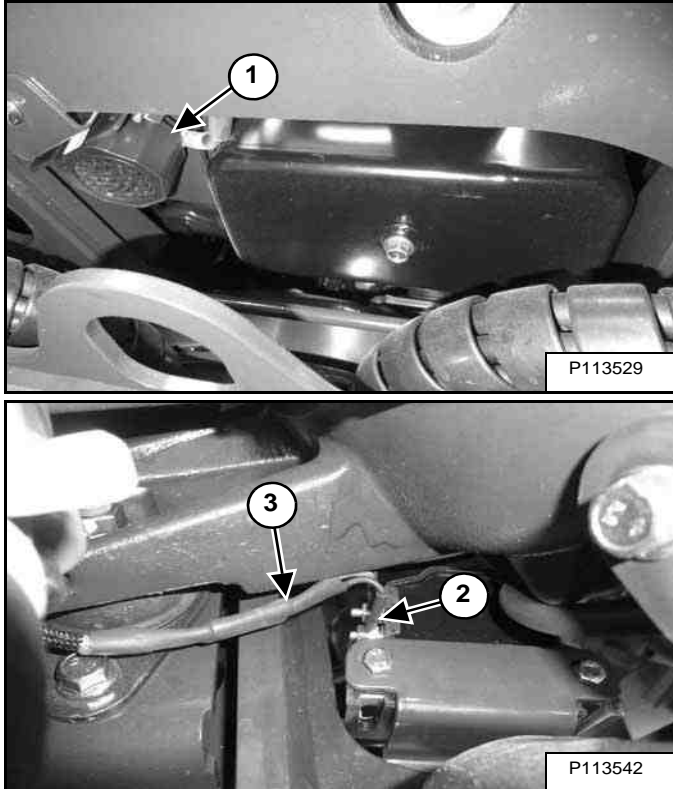

The motion alarm (Item 1) [Figure 153] is mounted to the bottom rear of the excavator. (Next to the engine oil pan.)

Inspect the motion alarm electrical connections (Item 2), wire harness (Item 3) [Figure 153] and motion alarm switch (Item 1) [Figure 154] for tightness and damage. Repair or replace any damaged components.

The motion alarm switch are non-adjustable, see the following information.

WARNING

This machine is equipped with a motion alarm.
ALARM MUST SOUND!
when operating forward or backward.

Failure to maintain a clear view in the direction of travel could result in serious injury or death.

The operator is responsible for the safe operation of this machine.

W-2786-0309

Adjusting Switch Position

The two motion alarm switches are located in the two travel control sections of the control valve that is located under the floorplate. Remove the floor mat and the floorplate. (See the Service Manual for the correct procedure.)

Figure 154

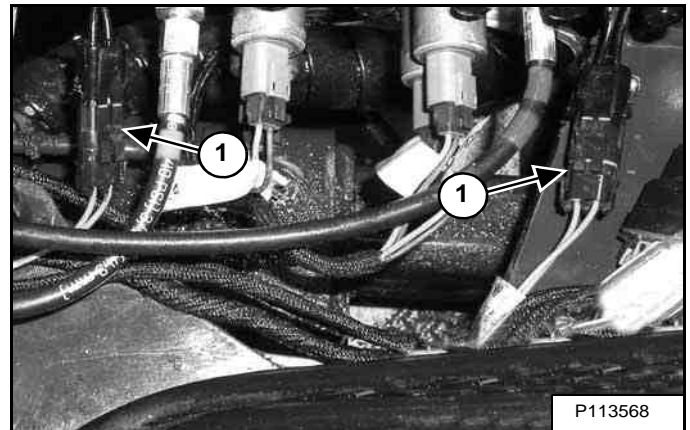

The two switches are non-adjustable.

Inspect the motion alarm electrical connections (Item 1) [Figure 154] and wire harness for damage. Repair or replace any damaged components.

Inspect the motion alarm system for proper function after switch replacement.

TAILGATE

Opening And Closing



AVOID INJURY OR DEATH

Never service or adjust the machine when the engine is running unless instructed to do so in the manual.

W-2012-0497



Keep the rear door closed when operating the machine. Failure to do so could seriously injure a bystander.

W-2020-1285

Figure 155

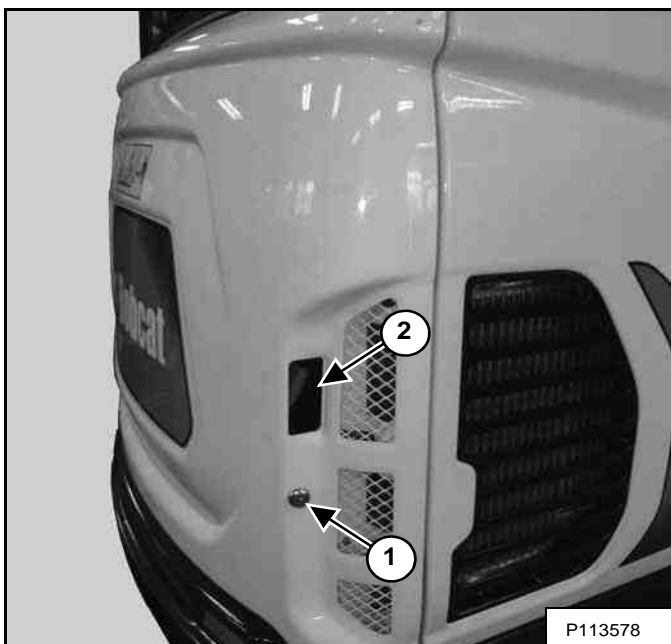

The tailgate can be locked (Item 1) [Figure 155] with the same key as the starter switch.

Pull on the latch (Item 2) [Figure 155] and open the tailgate.

Open the tailgate and rotate outward until it is held open by the latch (Item 1) [Figure 156].

Figure 156

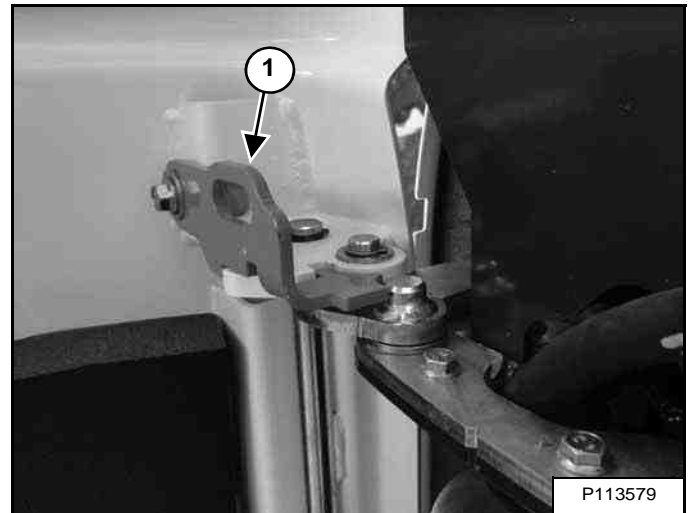

To close the tailgate, lift up on the latch (Item 1) [Figure 156] and slowly start to close the tailgate.

Push firmly to close the tailgate.

Adjusting The Latch

Figure 157

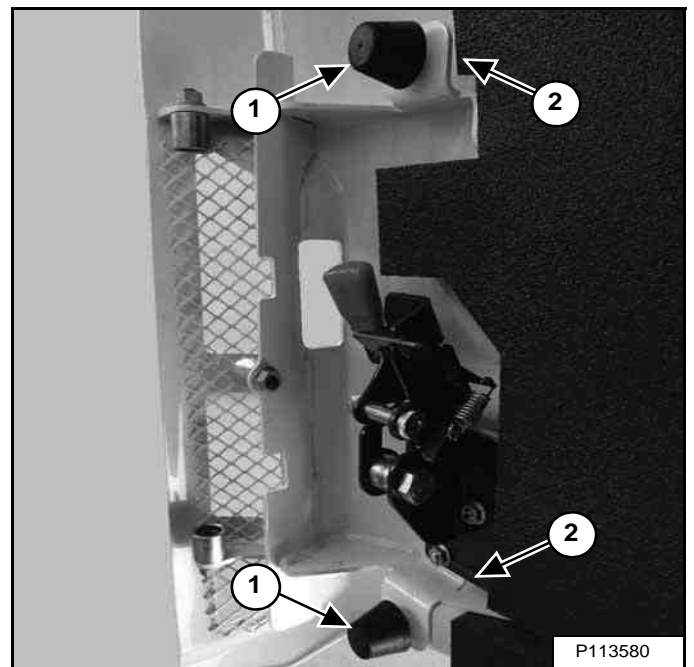

The tailgate can be adjusted at the two rubber bumpers (Item 1). Loosen the four nuts (Item 2) [Figure 157] and adjust the bumpers until the tailgate does not vibrate. Tighten the nuts securely after adjustment is completed.

Close the tailgate before operating the excavator.

RIGHT SIDE COVER

Opening And Closing

Right Side

Figure 158

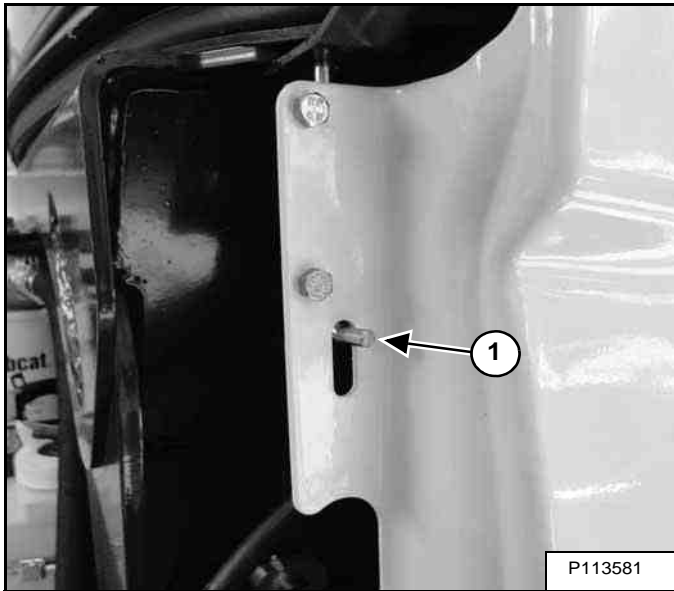

Open the tailgate to access the right side cover latch (Item 1) [Figure 158].

Pull the lever (Item 1) [Figure 158] down and open the right side cover.

Figure 159

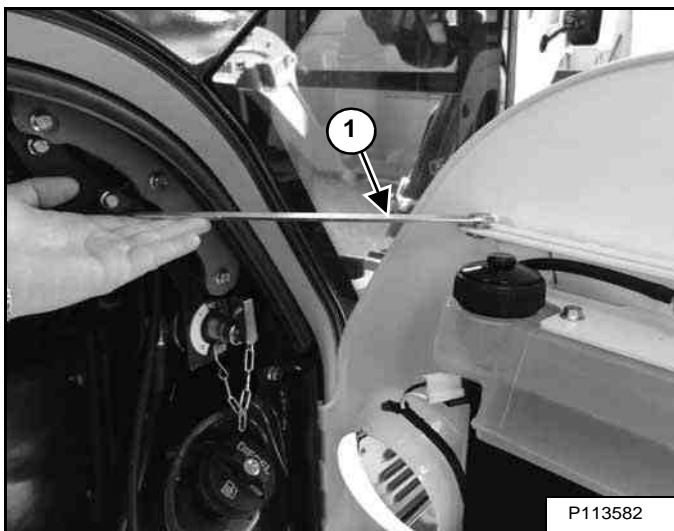

Open the right side cover and rotate forward until it is held open by the latch (Item 1) [Figure 159].

To close the tailgate, lift up on the latch (Item 1) [Figure 159] and slowly start to close the tailgate.

CAB FILTERS

Cleaning And Maintenance

Fresh Air Filter

The fresh air filter must be cleaned regularly. (See SERVICE SCHEDULE on Page 103.)

The fresh air filter is located on the right front corner of the cab.

Figure 160

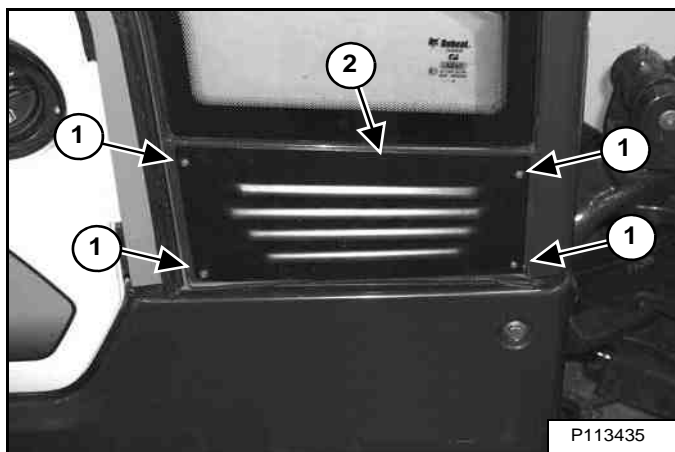

Remove the four screws (Item 1) and remove the cover (Item 2) [Figure 160].

Figure 161

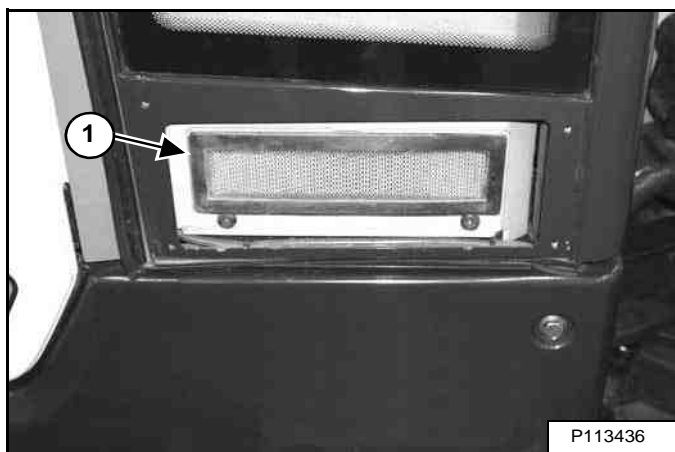

Pull the filter (Item 1) [Figure 161] out of the housing.

Use low air pressure to clean the filter. Replace the filter when very dirty.

Reinstall the cover (Item 2) and the four screws (Item 1) [Figure 160].

AIR CLEANER SERVICE

See the service schedule for the correct service interval. (See SERVICE SCHEDULE on Page 103.)

Daily Check

The air cleaner is located in the engine compartment. Open the tailgate to access the air cleaner for service. (See TAILGATE on Page 109.)

Figure 162

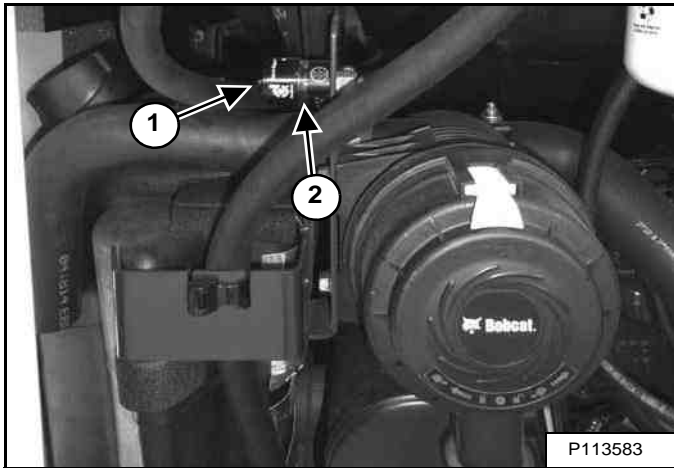

Check the condition indicator (Item 1). If the red ring (Item 2) [Figure 162] shows in the condition indicator, the filter needs to be replaced.

Replace the inner filter every third time the outer filter is replaced or as indicated.

Replacing The Filter Elements

Outer Filter

Figure 163

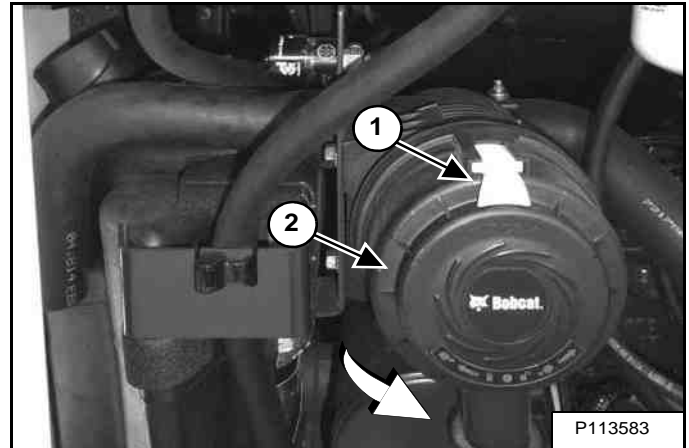

Pull out on the latch (Item 1). Rotate the cover anticlockwise and remove the dust cover (Item 2) [Figure 163].

Figure 164

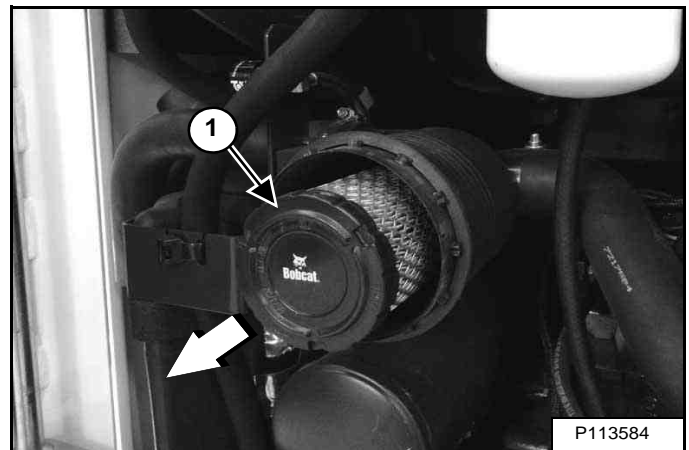

Slightly rotate the filter and pull the outer filter (Item 1) [Figure 164] from the air cleaner housing.

Check the housing for damage.

Clean the housing and the seal surface. DO NOT use compressed air.

Install a new filter.

AIR CLEANER SERVICE (CONT'D)

Replacing The Filter Elements (Cont'd)

Figure 165

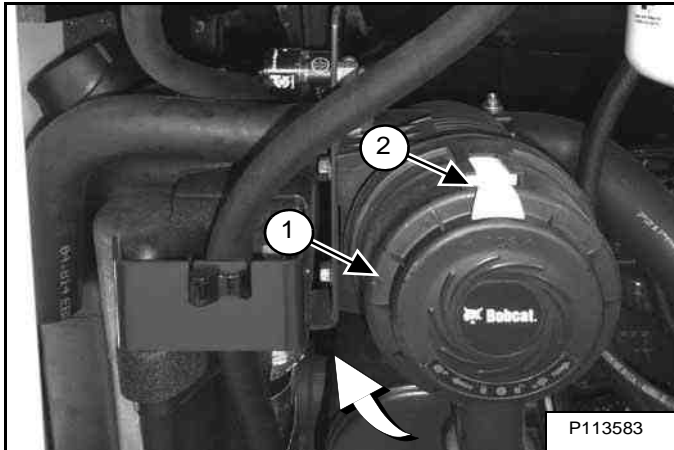

Position the dust cover (Item 1) [Figure 165] to the housing. Rotate the housing clockwise until the latch is at the top as shown.

Secure the dust cover (Item 1) and by pushing in on the latch (Item 2) [Figure 165].

Check the air intake hose and the air cleaner housing for damage. Make sure all connections are tight.

After the outer filter has been replaced, press the button (Item 2) [Figure 162] on the end of the condition indicator.

Start the engine. Run at full rpm, then reduce engine speed and stop the engine.

If the red ring (Item 1) [Figure 162] shows in the condition indicator, replace the inner filter.

Inner Filter

Only replace the inner filter under the following conditions:

- Replace the inner filter every *third* time the outer filter is replaced.
- After the outer filter has been replaced, press the button (Item 2) [Figure 162] on the condition indicator and start the engine. Run at full rpm, then reduce engine speed and stop the engine. If the red ring shows in the condition indicator, replace the inner filter.

Figure 166

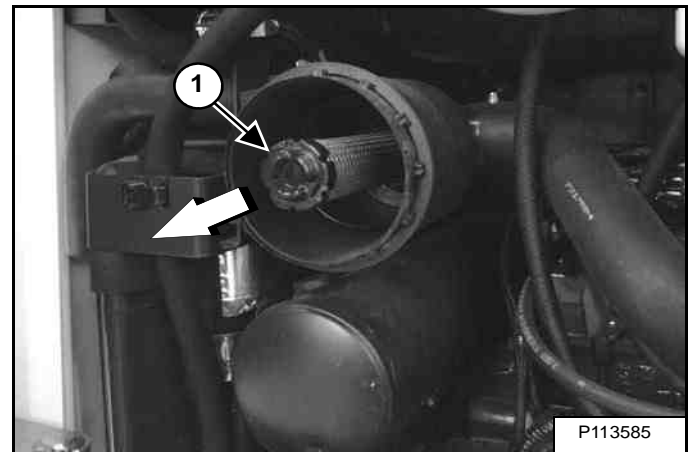

Remove the dust cover, outer filter and inner filter (Item 1) [Figure 166].

NOTE: Make sure all sealing surfaces are free of dirt and debris.

Install the new inner filter.

Install the outer filter and the dust cover.

Press the button on the condition indicator to reset the red ring.



FUEL SYSTEM

Fuel Specifications

Ultra low sulfur diesel fuel must be used in this machine. Ultra low sulfur is defined as 15 mg/kg (15 ppm) sulfur maximum.

Use only clean, high quality diesel fuel, Grade Number 2-D or Grade Number 1-D.

The following is one suggested blending guideline that should prevent fuel gelling during cold temperatures:

TEMPERATURE	GRADE 2-D	GRADE 1-D
Above -9°C (+15°F)	100%	0%
Down to -21°C (-5°F)	50%	50%
Below -21°C (-5°F)	0%	100%

NOTE: Contact your local fuel supplier to receive specific recommendations for your region.

NOTE: Biodiesel blend fuel may also be used in this machine. Biodiesel blend fuel must contain no more than five percent biodiesel mixed with ultra low sulfur petroleum based diesel. This biodiesel blend fuel is commonly marketed as B5 blended diesel fuel. B5 blended diesel fuel must meet ASTM D975 (US Standard) or EN590 (EU Standard) specifications.

Biodiesel Blend Fuel

Biodiesel blend fuel has unique qualities that should be considered before using in this machine:

- Cold weather conditions can lead to plugged fuel system components and hard starting.
- Biodiesel blend fuel is an excellent medium for microbial growth and contamination that can cause corrosion and plugging of fuel system components.
- Use of biodiesel blend fuel may result in premature failure of fuel system components, such as: plugged fuel filters and deteriorated fuel lines.
- Shorter maintenance intervals may be required, such as: cleaning the fuel system and replacing fuel filters and fuel lines.
- Using biodiesel blended fuels containing more than five percent biodiesel can affect engine life and cause deterioration of hoses, tubelines, injectors, injector pump, and seals.

Apply the following guidelines if biodiesel blend fuel is used:

- Ensure the fuel tank is as full as possible at all times to prevent moisture from collecting in the fuel tank.
- Ensure that the fuel tank cap is securely tightened.
- Biodiesel blend fuel can damage painted surfaces, remove all spilled fuel from painted surfaces immediately.
- Drain all water from the fuel filter daily before operating the machine.
- Do not exceed engine oil change interval. Extended oil change intervals can cause engine damage.
- Before machine storage; drain the fuel tank, refill with 100% petroleum diesel fuel, add fuel stabilizer, and operate the engine for at least 30 minutes.

NOTE: Biodiesel blend fuel does not have long term stability and should not be stored for more than 3 months.

FUEL SYSTEM (CONT'D)

Filling The Fuel Tank

Figure 167

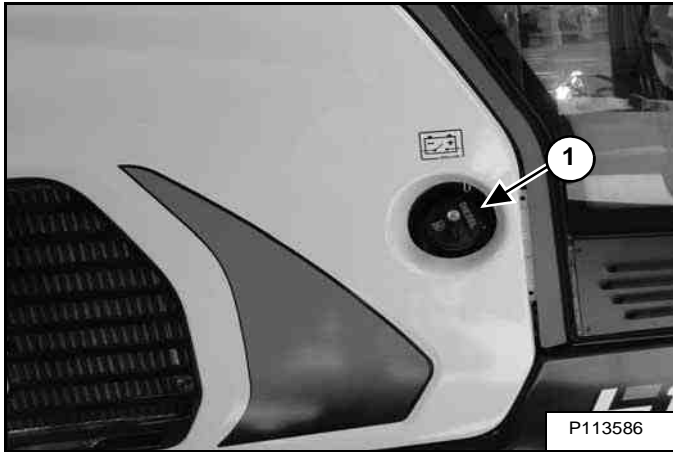

The fuel cap uses the start key to unlock the fuel cap.

Remove the fuel fill cap (Item 1) [Figure 167].

Use a clean, approved safety container to add fuel. Add fuel only in an area that has a free movement of air and no flames or sparks. **NO SMOKING!**

Install and tighten the fuel fill cap.

Clean up any spilled fuel.

See the service schedule for the service interval when to remove water from or replace the fuel filter. (See SERVICE SCHEDULE on Page 103.)

NOTE: When filling the fuel tank, with the left console raised, turn the start switch to the ON position. As fuel is added to the tank, a buzzer will beep and the closer the tank gets to full, the quicker the beeps. When the tank is full, the buzzer will sound continuously. Stop fuelling when buzzer sounds continuously. Turn the start switch OFF.

WARNING

AVOID INJURY OR DEATH

Stop and cool the engine before adding fuel. **NO SMOKING!** Failure to obey warnings can cause an explosion or fire.

W-2063-0807

WARNING

AVOID INJURY OR DEATH

Always clean up spilled fuel or oil. Keep heat, flames, sparks or lighted tobacco away from fuel and oil. Failure to use care around combustibles can cause explosion or fire.

W-2103-0508

FUEL SYSTEM (CONT'D)

Fuel Filter

Removing Water

Open the tailgate. (See TAILGATE on Page 109.)

Figure 168

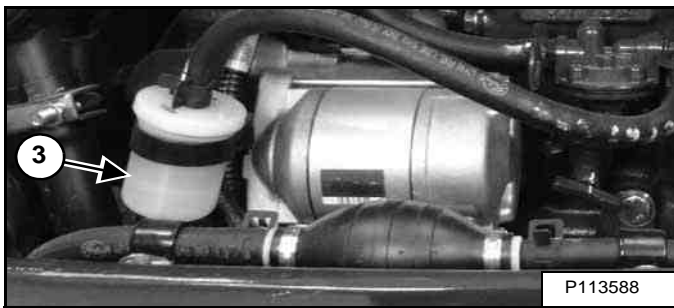
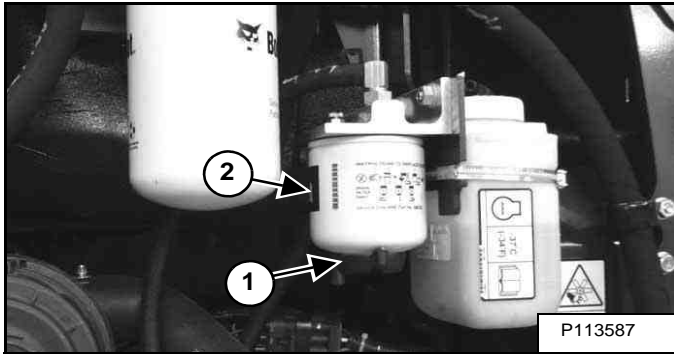

Loosen the drain (Item 1) [Figure 168] at the bottom of the filter to drain water from the filter into a container.

Inspect the fuel pre-filter (Item 3) [Figure 168] daily for moisture and contamination. Replace as necessary.

Clean up any spilled fuel.

Replacing Elements

Remove and replace the fuel pre-filter (Item 3) [Figure 168].

Remove the filter (Item 2) [Figure 168].

Clean the area around the filter housing. Put clean oil on the seal of the new filter. Install the fuel filter and hand tighten.

Remove the air from the fuel system. (See Removing Air From The Fuel System on Page 117.)

WARNING

AVOID INJURY OR DEATH

Diesel fuel or hydraulic fluid under pressure can penetrate skin or eyes, causing serious injury or death. Fluid leaks under pressure may not be visible. Use a piece of cardboard or wood to find leaks. Do not use your bare hand. Wear safety goggles. If fluid enters skin or eyes, get immediate medical attention from a doctor familiar with this injury.

W-2072-EN-0909

Draining The Fuel Tank

See the service schedule for the correct service interval. (See SERVICE SCHEDULE on Page 103.)

The fuel tank can be drained in several ways. See below.

Figure 169

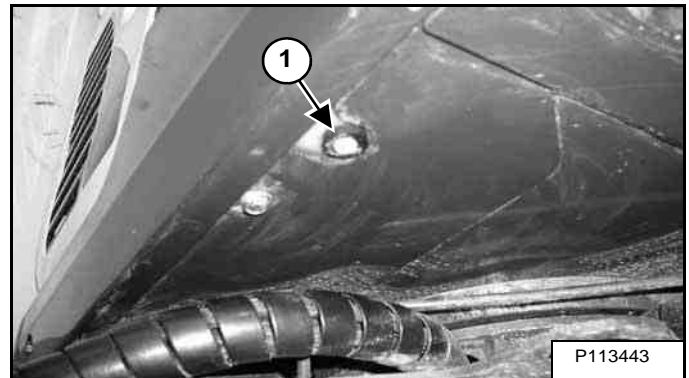

Rotate the upperstructure so the fuel tank drain plug (Item 1) is located between the rear tracks. Remove the drain plug (Item 1) [Figure 169].

Drain the fuel into the container.

Reuse, recycle or dispose of fuel in an environmentally safe manner.

Reinstall the drain plug.

Figure 170

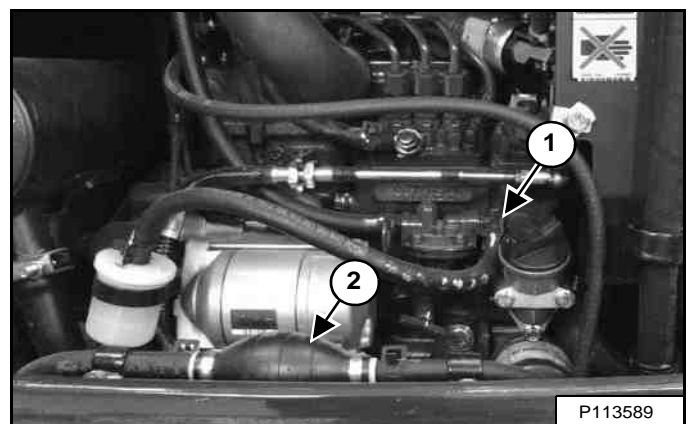

Second option for draining tank. Remove the fuel hose (Item 1) at the fuel pump. Route the hose out of the engine compartment and into a container. Squeeze the primer bulb (Item 2) [Figure 170] to start a siphon and drain the tank.

Reinstall the fuel hose (Item 1) [Figure 170].

FUEL SYSTEM (CONT'D)

Removing Air From The Fuel System

After replacing the fuel filter or when the fuel tank has run out of fuel, air must be removed from the fuel system before starting the engine.

Open the tailgate. (See Opening And Closing on Page 109.)

Figure 171

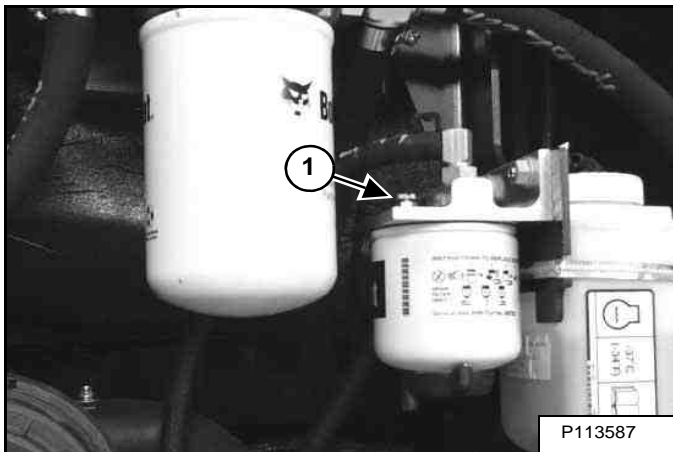
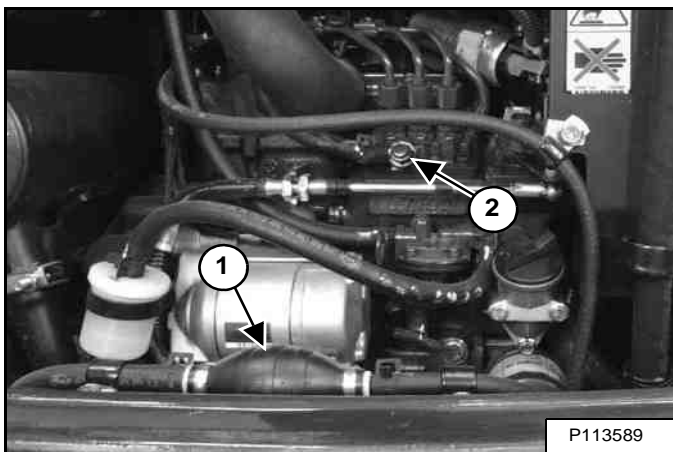

Figure 172



Open the fuel filter vent (Item 1) [Figure 171] and operate the hand pump (priming bulb) (Item 1) [Figure 172] until the fuel flows from the vent (Item 1) [Figure 171] with no air bubbles.

Close the vent (Item 1) [Figure 171].

Start the engine. It may be necessary to open the vent (Item 2) [Figure 172] (at the fuel injection pump) briefly until the engine runs smoothly.

WARNING

AVOID INJURY OR DEATH

Diesel fuel or hydraulic fluid under pressure can penetrate skin or eyes, causing serious injury or death. Fluid leaks under pressure may not be visible. Use a piece of cardboard or wood to find leaks. Do not use your bare hand. Wear safety goggles. If fluid enters skin or eyes, get immediate medical attention from a doctor familiar with this injury.

W-2072-EN-0909

ENGINE LUBRICATION SYSTEM

Checking And Adding Engine Oil

Check the engine oil after every 8 - 10 hours of operation and before starting the engine. (See SERVICE SCHEDULE on Page 103.)

Figure 173

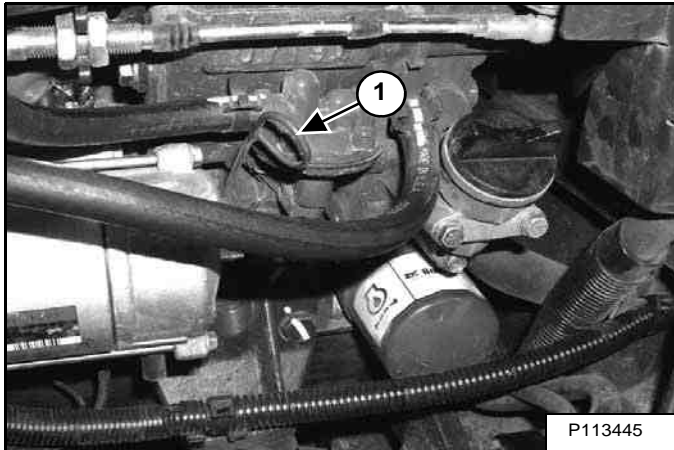

Open the tailgate and remove the dipstick (Item 1) [Figure 173].

Keep the oil level between the marks on the dipstick.

Use a good quality motor oil that meets the correct API Service Classification.

Engine Oil Chart

Figure 174

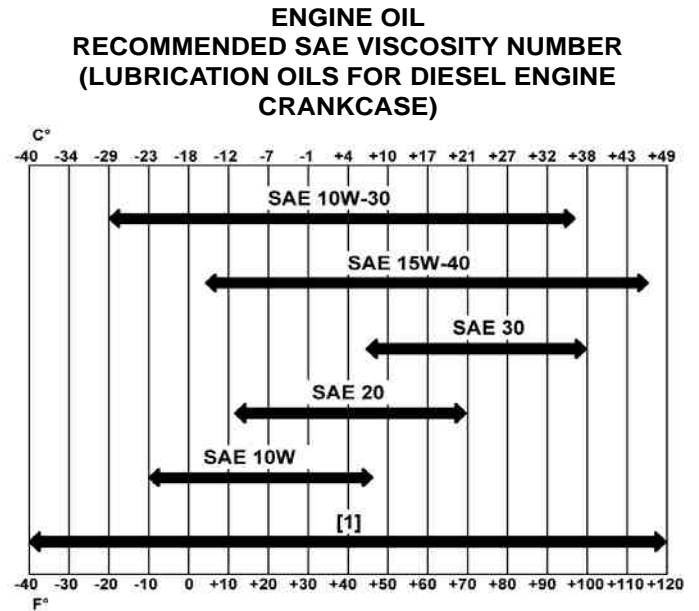

**TEMPERATURE RANGE ANTICIPATED BEFORE
NEXT OIL CHANGE (DIESEL ENGINES MUST USE API
CLASSIFICATION CI-4 OR BETTER)**

[1] Synthetic Oil - Use recommendation from Synthetic Oil Manufacturer.

Use good quality engine oil that meets API Service Classification of CI-4 or better [Figure 174].



AVOID INJURY OR DEATH

Always clean up spilled fuel or oil. Keep heat, flames, sparks or lighted tobacco away from fuel and oil. Failure to use care around combustibles can cause explosion or fire.

W-2103-0508

ENGINE LUBRICATION SYSTEM (CONT'D)

Removing And Replacing Oil And Filter

See the service schedule for the service interval for replacing the engine oil and filter. (See SERVICE SCHEDULE on Page 103.)

Rotate upperstructure so that the oil drain plug is between the rear tracks.

Run the engine until it is at operating temperature. Stop the engine.

Open the tailgate. (See Opening And Closing on Page 109.)

Figure 175

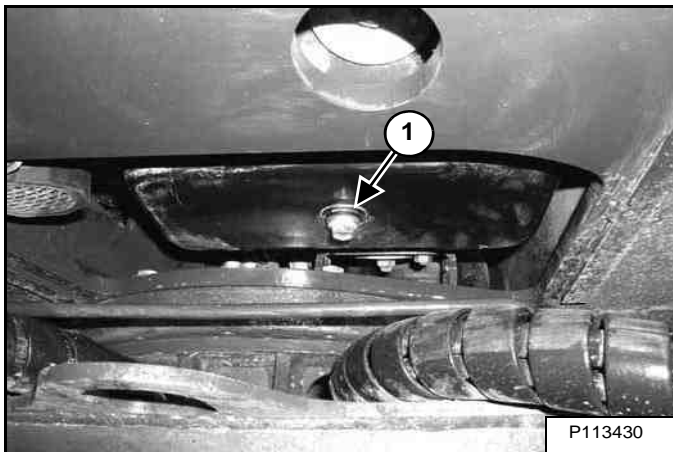

Place a container under the oil pan. Remove the drain plug (Item 1) [Figure 175] from the bottom of the engine oil pan.

Recycle or dispose of used oil in an environmentally safe manner.

Figure 176

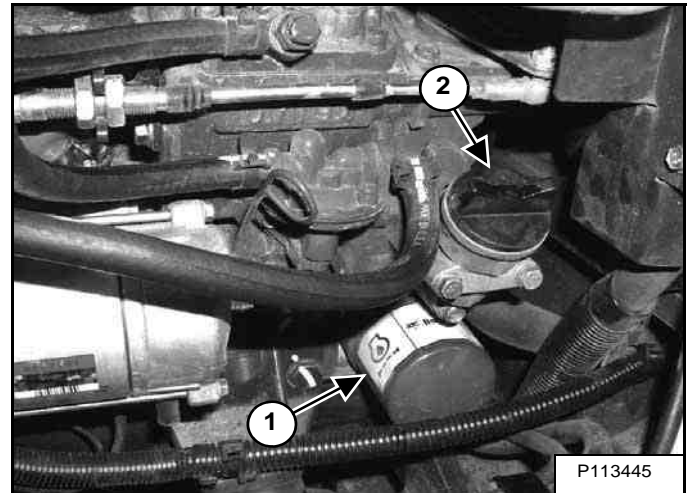

Remove the oil filter (Item 1) [Figure 176] and clean the filter housing surface.

Use a genuine Bobcat replacement filter. Put clean oil on the filter gasket. Install the filter and hand tighten.

Install and tighten the drain plug (Item 1) [Figure 175].

Remove the fill cap (Item 1) [Figure 176].

Put oil in the engine. (See Checking And Adding Engine Oil on Page 118.)

Install the fill cap (Item 1) [Figure 176].

Start the engine and let it run for several minutes.

Stop the engine. Check for leaks at the oil filter. Check the oil level.

Add oil as needed if it is not at the top mark on the dipstick.



ENGINE COOLING SYSTEM

Check the cooling system every day to prevent overheating, loss of performance or engine damage. (See SERVICE SCHEDULE on Page 103.)

Cleaning

NOTE: This excavator uses a pusher fan so flow through the radiator / oil cooler will be from inside the engine compartment to outside the right cover. When cleaning the radiator, clean both the inside and outside surfaces of the radiator / oil cooler.

Open the tailgate. (See Opening And Closing on Page 109.)

Open the right side cover. (See Opening And Closing on Page 110.)

NOTE: Allow the cooling system and engine to cool before servicing or cleaning the cooling system.

Figure 177

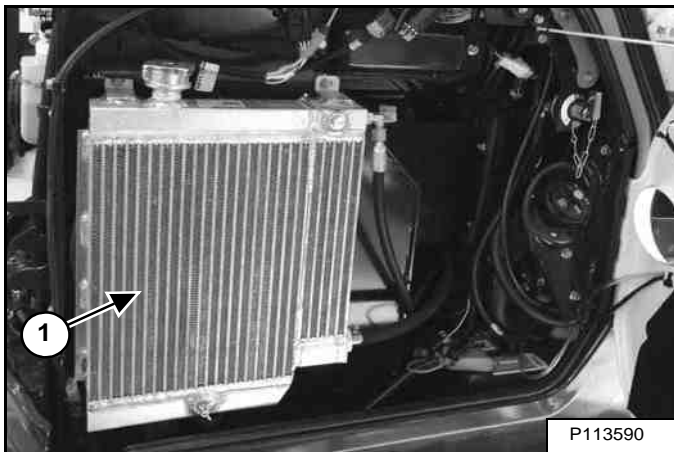

Use air pressure or water pressure to clean the radiator / oil cooler (Item 1) [Figure 177] (both inside and outside surfaces). Be careful not to damage fins when cleaning.

Close the right side cover. (See Opening And Closing on Page 110.)

Close the tailgate. (See Opening And Closing on Page 109.)

ENGINE COOLING SYSTEM (CONT'D)

Checking Level

! WARNING

AVOID BURNS

Do not remove radiator cap when the engine is hot. You can be seriously burned.

W-2070-1203

! WARNING

AVOID INJURY OR DEATH

Wear safety glasses to prevent eye injury when any of the following conditions exist:

- When fluids are under pressure.
- Flying debris or loose material is present.
- Engine is running.
- Tools are being used.

W-2019-0907

IMPORTANT

AVOID ENGINE DAMAGE

Always use the correct ratio of water to antifreeze.

Too much antifreeze reduces cooling system efficiency and may cause serious premature engine damage.

Too little antifreeze reduces the additives which protect the internal engine components; reduces the boiling point and freeze protection of the system.

Always add a premixed solution. Adding full strength concentrated coolant can cause serious premature engine damage.

I-2124-0497

Open the tailgate. (See Opening And Closing on Page 109.)

Figure 178

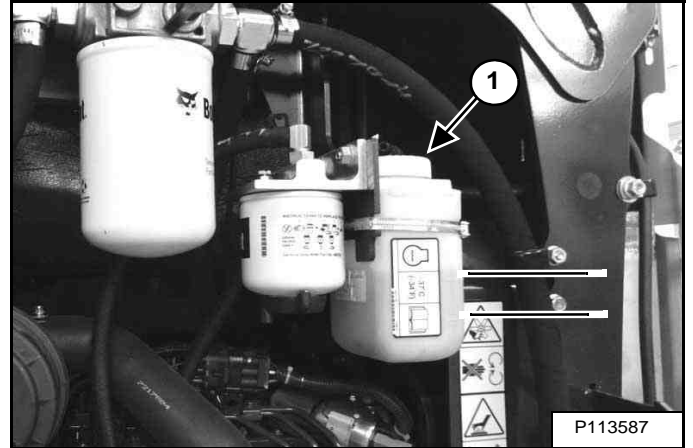

Check the coolant level in the coolant recovery tank (Item 1) [Figure 178].

The coolant level must be filled so it is within the MAX / MIN line marked the coolant recovery tank.

NOTE: The cooling system is factory filled with propylene glycol (purple colour). **DO NOT** mix propylene glycol with ethylene glycol.

ENGINE COOLING SYSTEM (CONT'D)

Removing And Replacing Coolant

See the service schedule for correct service intervals. (See SERVICE SCHEDULE on Page 103.)

Stop the engine. Open the tight side cover. (See Opening And Closing on Page 110.)

! WARNING

AVOID BURNS

Do not remove radiator cap when the engine is hot. You can be seriously burned.

W-2070-1203

Figure 179

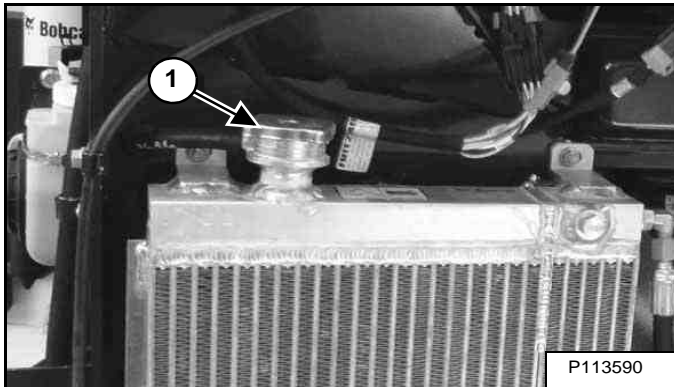

When the engine is cool, loosen and remove the coolant fill cap (Item 1) [Figure 179].

Figure 180

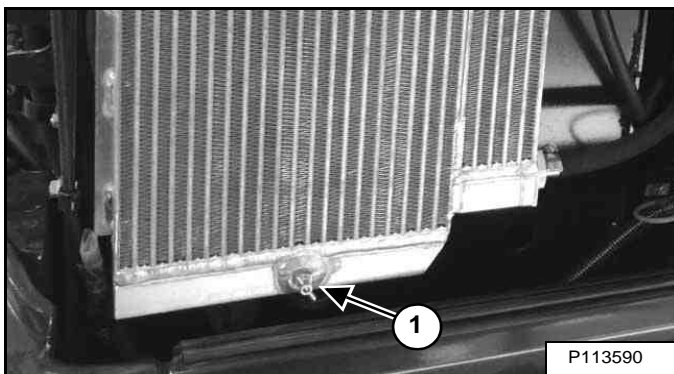

Install a hose on the drain valve at the bottom of the radiator. Open the drain valve (Item 1) [Figure 180] and drain the coolant into a container.

Figure 181

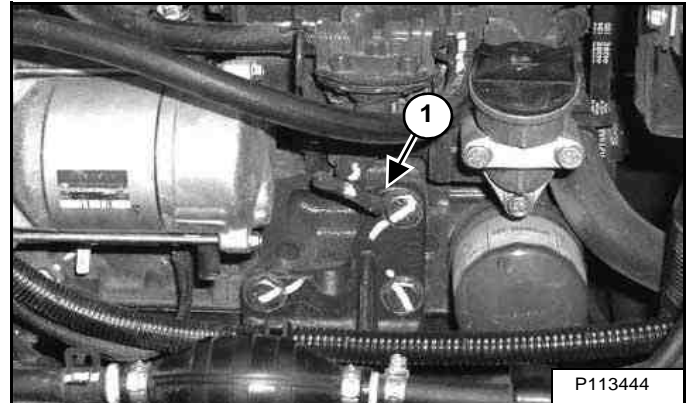

Install a hose on the drain valve located at the engine block by the end of the started. Open the drain valve (Item 1) [Figure 181] and drain the coolant into a container.

After all the coolant is removed, close both drain valves.

Recycle or dispose of the used coolant in an environmentally safe manner.

Mix the coolant in a separate container. (See Capacities on Page 164.)

NOTE: The cooling system is factory filled with propylene glycol (purple colour). DO NOT mix propylene glycol with ethylene glycol.

The correct mixture of coolant to provide a -37°C (-34°F) freeze protection is 5 L propylene glycol mixed with 4,4 L of water **OR** 1 U.S. gal propylene glycol mixed with 3.5 qt of water.

Add premixed coolant, 47% water and 53% propylene glycol to the coolant tank until the coolant level reaches the lower marker on the tank.

Use a refractometer to check the condition of propylene glycol in your cooling system.

Add premixed coolant until the level is correct. Install the coolant fill cap.

Run the engine until it is at operating temperature. Stop the engine. Check the coolant level when cool. Add coolant as needed. Install the coolant fill cap.

Close the tailgate.

ELECTRICAL SYSTEM

Description

Figure 182

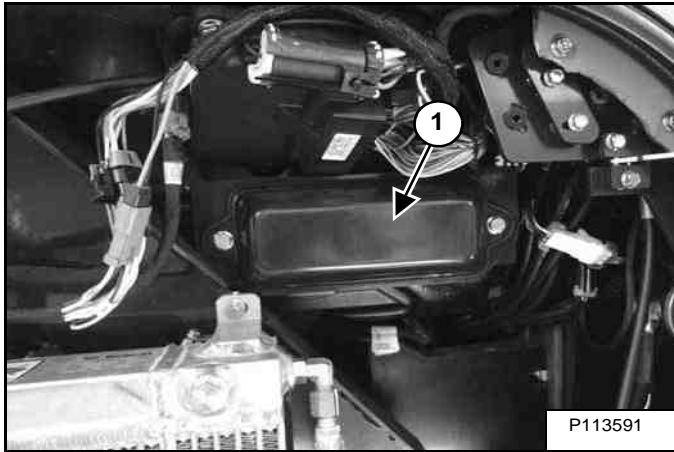

The excavator has a 12 volt, negative earth electrical system. The electrical system is protected by fuses located under the right side cover of the excavator (Item 1) **[Figure 182]**. The fuses will protect the electrical system when there is an electrical overload. The reason for the overload must be found and corrected before starting the engine again.

The battery cables must be clean and tight. Check the electrolyte level in the battery. Add distilled water as needed. Remove acid or corrosion from the battery and cables with a sodium bicarbonate and water solution.

Put Battery Saver P/N 6664458 or grease on the battery terminals and cable ends to prevent corrosion.



AVOID INJURY OR DEATH

Batteries contain acid which burns eyes and skin on contact. Wear goggles, protective clothing and rubber gloves to keep acid off body.

In case of acid contact, wash immediately with water. In case of eye contact get prompt medical attention and wash eye with clean, cool water for at least 15 minutes.

If electrolyte is taken internally drink large quantities of water or milk! DO NOT induce vomiting. Get prompt medical attention.

W-2065-0807

Fuse And Relay Location / Identification

A decal is inside the fuse cover to show location and amp ratings.

Remove the cover to check or replace the fuses and relays.

The location and amperage ratings are shown in **[Figure 183]**.

Always replace fuses using the same type and capacity.



ELECTRICAL SYSTEM (CONT'D)

Fuse And Relay Location / Identification (Cont'd)

Figure 183

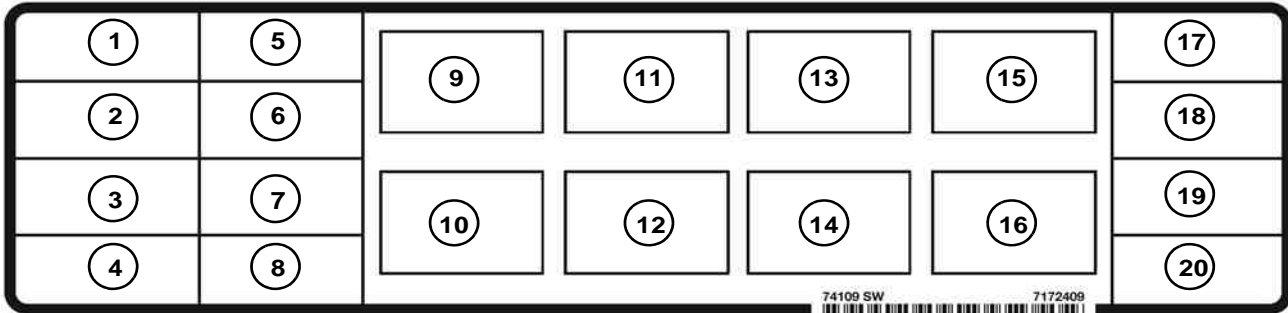

The location and amperage ratings are shown in the table below and on the decal [Figure 183]. Relays are identified by the letter “R” in the AMP column.

REF	ICON	DESCRIPTION	AMP	REF	ICON	DESCRIPTION	AMP	REF	ICON	DESCRIPTION	AMP
1		NOT USED		9		Switched Power	R	17		Panel / Display Controller	25
2		NOT USED		10		Fuel Shutoff	R	18		ACD Unswitched Power	25
3		Start Key	5	11		Heater Fan	R	19		Lights	25
4		Fuel Shutoff	25	12		Lights	R	20		Power Port	15
5		Wiper / Washer	10	13		Hydraulic By-Pass / Power Beyond	R				
6		Switched Power	20	14		Glow Plugs	R				
7		Alternator Excite / Heater	25	15		NOT USED	R				
8		ACD Switched Power	25	16		Starter	R				

ELECTRICAL SYSTEM (CONT'D)

Battery Disconnect Switch

When disconnecting or connecting the battery cables, turn the disconnect switch to the OFF position first.

Open the right side cover. (See RIGHT SIDE COVER on Page 110.)

Figure 184

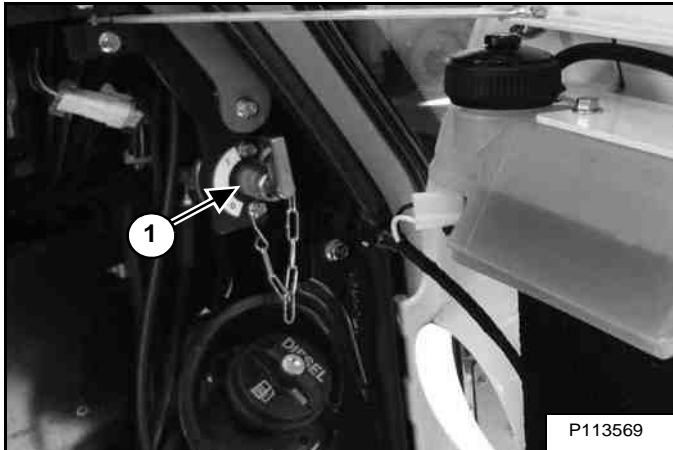

The disconnect switch (Item 1) **[Figure 184]** is located under the right side cover, above the fuel fill cap.

Rotate the switch (Item 1) **[Figure 184]** anticlockwise to turn the switch to the OFF position, clockwise to turn to the ON position (shown in ON position).

NOTE: In the OFF position the shut-off switch key can be removed from the switch. The key is secured to the switch mount with a chain.

ELECTRICAL SYSTEM (CONT'D)

Battery Maintenance

Open the right side cover. (See Opening And Closing on Page 110.)

Figure 185

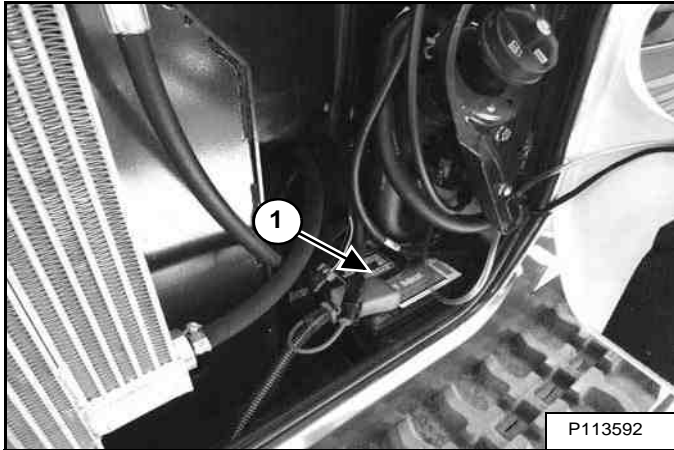

The battery (Item 1) [Figure 185] is located in the right side upperstructure below the oil cooler.

Figure 186

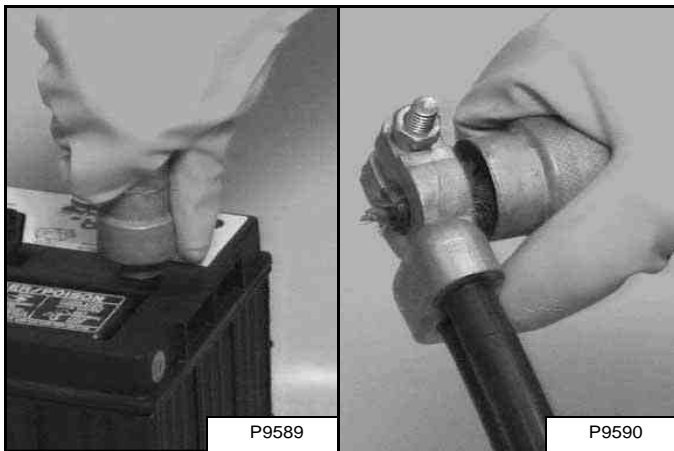

The battery cables must be clean and tight [Figure 186]. Remove acid or corrosion from the battery and cables using a sodium bicarbonate and water solution. Cover the battery terminals and cable ends with battery saver grease to prevent corrosion.

Check for broken or loose connections.

If the battery cables are to be removed for any reason, disconnect the negative (-) cable first. When installing the battery cables, make the last connection the negative (-) cable to the battery.

The original equipment battery is maintenance free. If a replacement battery is installed, check the electrolyte level in the battery.

If the electrolyte level is lower than 13 mm (0.50 in) above the plates, add distilled water only.

! WARNING

AVOID INJURY OR DEATH

Batteries contain acid which burns eyes and skin on contact. Wear goggles, protective clothing and rubber gloves to keep acid off body.

In case of acid contact, wash immediately with water. In case of eye contact get prompt medical attention and wash eye with clean, cool water for at least 15 minutes.

If electrolyte is taken internally drink large quantities of water or milk! DO NOT induce vomiting. Get prompt medical attention.

W-2065-0807

Using A Booster Battery (Jump Starting)

IMPORTANT

If jump starting the excavator from a second machine:

When jump starting the excavator from a battery installed in a second machine, make sure the engine is NOT running while using the glow plugs. High voltage spikes from a running machine can burn out the glow plugs.

I-2060-0906

If it is necessary to use a booster battery to start the engine, BE CAREFUL! There must be one person in the operator's seat and one person to connect and disconnect the battery cables.

Be sure the key switch is OFF. The booster battery must be 12 volt.

Open the tailgate. (See Opening And Closing on Page 109.)

ELECTRICAL SYSTEM (CONT'D)

Using A Booster Battery (Jump Starting) (Cont'd)

NOTE: To access the battery for jump starting, the battery hold-down will need to be removed and the battery moved outward to access the positive battery post.

Figure 187

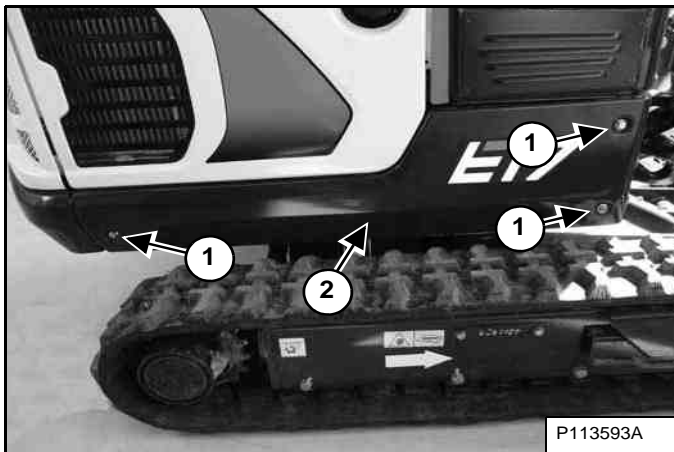

Remove the three bolts (Item 1) and remove the right side lower cover (Item 2) [Figure 187].

Open the right side cover. (See Opening And Closing on Page 110.)

Figure 188

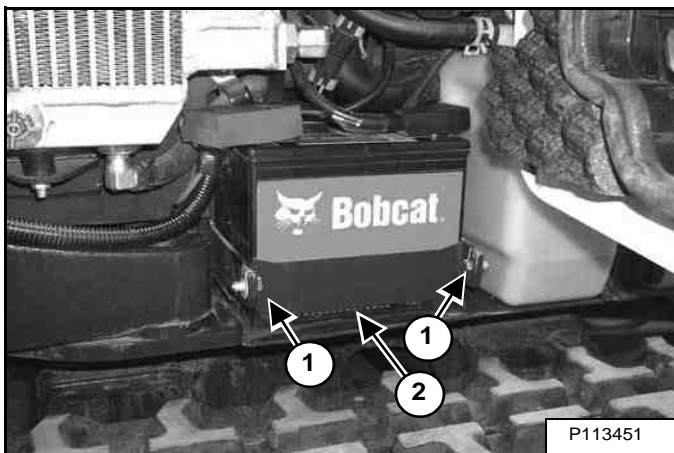

Remove the two bolts (Item 1) and remove the battery hold-down plate (Item 2) [Figure 187].

Figure 189

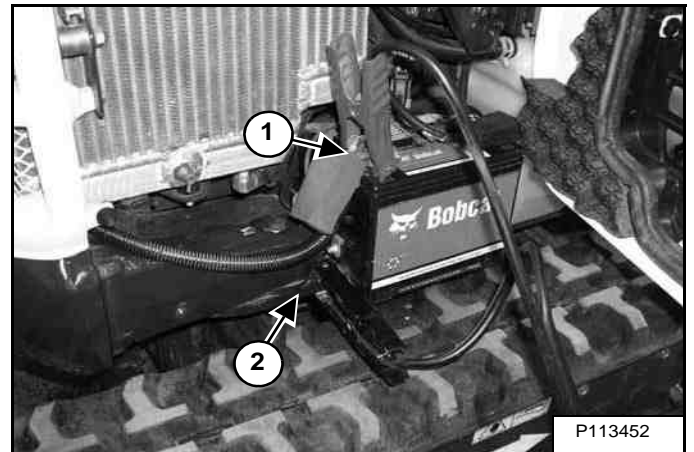

Connect one end of the first cable to the positive (+) terminal of the booster battery. Connect the other end of the same cable to the positive (+) terminal (Item 1) [Figure 187] of the excavator battery.

Connect one end of the second cable to the negative (-) terminal of the booster battery. Connect the other end of the same cable to a frame earth point (Item 2) [Figure 189].

Start the engine. After the engine has started, remove the negative (-) cable first (Item 1) [Figure 189].

Disconnect the cable from the excavator starter (Item 1) [Figure 187].

Replace the positive battery cable cover and push the battery in fully. Reinstall the battery hold-down plate (Item 2) and the two bolts (Item 1) [Figure 188].

Reinstall the lower right side cover [Figure 187].

NOTE: (See Cold Temperature Starting on Page 70.)

IMPORTANT

Damage to the alternator can occur if:

- Engine is operated with battery cables disconnected.
- Battery cables are connected when using a fast charger or when welding on the excavator. (Remove both cables from the battery.)
- Extra battery cables (booster cables) are connected wrong.

I-2223-0903

ELECTRICAL SYSTEM (CONT'D)

Removing And Installing The Battery

Figure 190

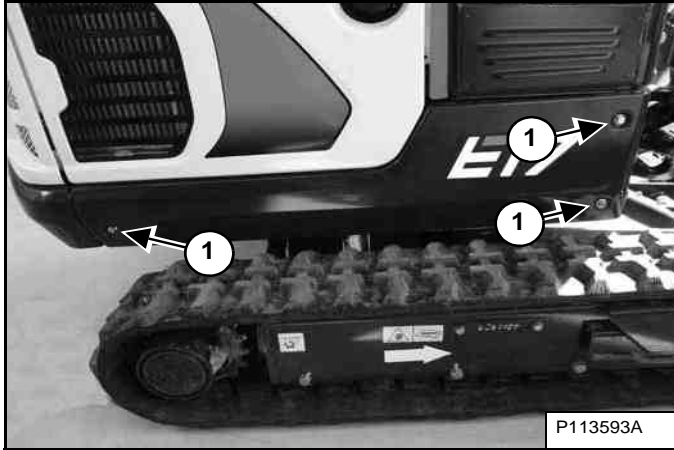

Remove the three bolts (Item 1) and remove the right side lower cover (Item 2) [Figure 190].

Open the right side cover. (See Opening And Closing on Page 110.)

Turn the battery disconnect switch to the OFF position. (See Battery Disconnect Switch on Page 125.)

Figure 191

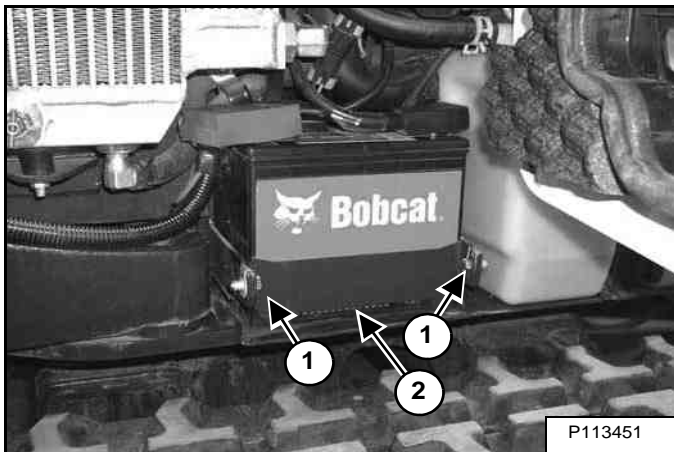

Remove the two bolts (Item 1) and remove the battery hold-down plate (Item 2) [Figure 191].

Slide the battery to the right to access the battery cables.

Figure 192

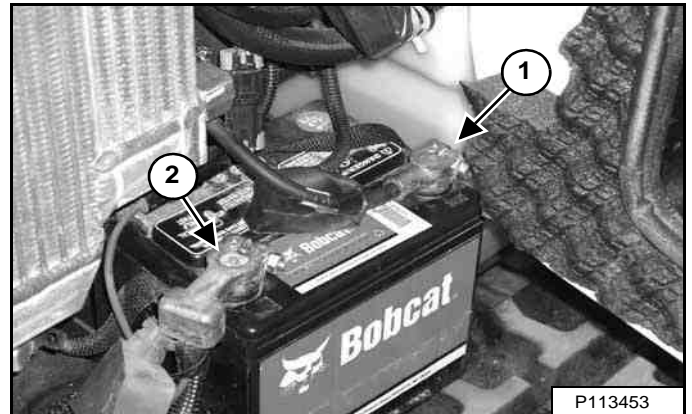

Disconnect the negative (-) cable (Item 1) [Figure 192] first.

Disconnect the positive (+) cable (Item 2) [Figure 192].

Remove the battery.

Always clean the terminals and the cable ends, even when installing a new battery.

Position the battery into the battery box.

Connect the battery cables. Connect the negative (-) cable (Item 1) [Figure 192] last to prevent sparks. Reinstall the battery post covers and slide the battery in fully.

Tighten the terminal clamp nuts to 7 N•m (5 ft-lb) torque.

Install the hold-down plate (Item 2) and the two bolts (Item 1) [Figure 187]. Reinstall the lower cover [Figure 190].

Turn the battery disconnect switch to the ON position. (See Battery Disconnect Switch on Page 125.)

WARNING

AVOID INJURY OR DEATH

Batteries contain acid which burns eyes and skin on contact. Wear goggles, protective clothing and rubber gloves to keep acid off body.

In case of acid contact, wash immediately with water. In case of eye contact get prompt medical attention and wash eye with clean, cool water for at least 15 minutes.

If electrolyte is taken internally drink large quantities of water or milk! DO NOT induce vomiting. Get prompt medical attention.

W-2065-0807

HYDRAULIC SYSTEM

Checking And Adding Hydraulic Fluid

Put the machine on a flat level surface.

Retract the arm and bucket cylinders, put the bucket on the ground and lower the blade. Stop the engine.

Open the right side cover. (See Opening And Closing on Page 110.)

Figure 193

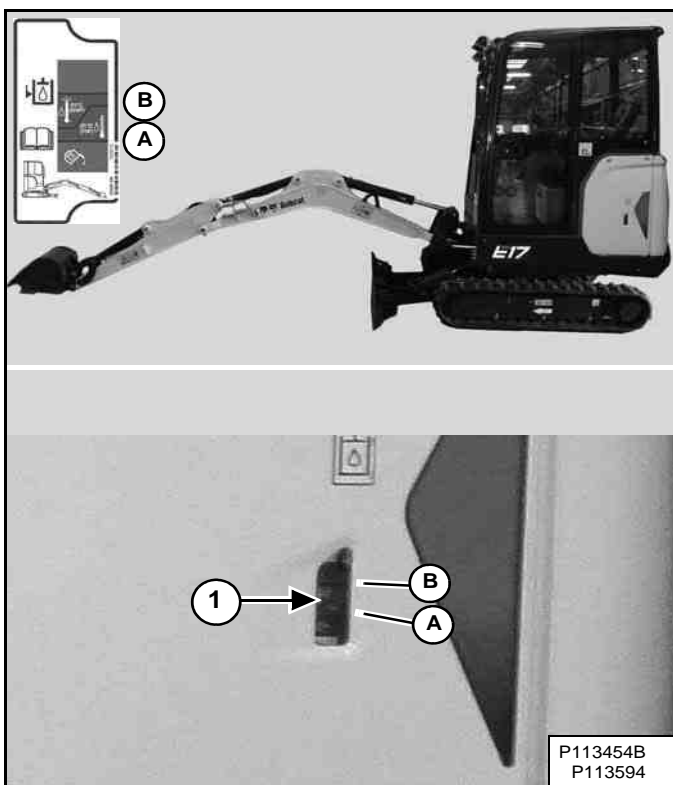

Park the machine in the position shown [Figure 193]. (The preferred method is to check the hydraulic fluid when it is cold.)

Check the hydraulic fluid level, it must be visible in the sight gauge (Item 1) [Figure 193]. The decal on the hydraulic tank shows the correct fill level.

- A - Correct Oil Level COLD (Preferred)
- B - Correct Oil Level HOT (Optional)



AVOID INJURY OR DEATH

Always clean up spilled fuel or oil. Keep heat, flames, sparks or lighted tobacco away from fuel and oil. Failure to use care around combustibles can cause explosion or fire.

W-2103-0508

Figure 194

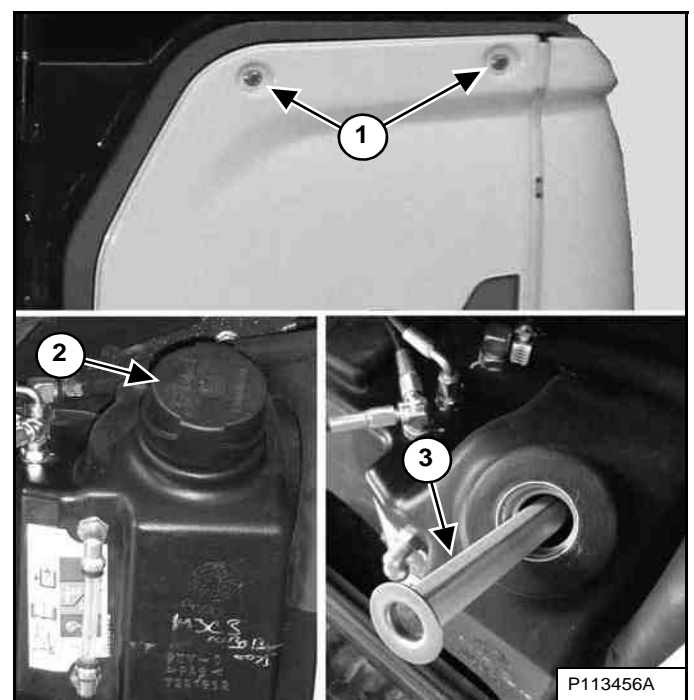

Remove the two screw (Item 1) [Figure 194] from the top of the left side cover and remove the cover.

Clean the surface around the reservoir cap (Item 2) [Figure 194] and remove the cap.

Check the condition of the fill strainer screen (Item 3) [Figure 194]. Clean or replace as necessary.

Be sure the screen is installed before adding fluid.

Add the correct fluid to the reservoir until it is visible in the sight gauge.

Check the cap and clean as necessary. Replace the cap if damaged.

Install the cap.

Close the right side cover and tailgate

HYDRAULIC SYSTEM (CONT'D)

Hydraulic / Hydrostatic Fluid Chart

Figure 195

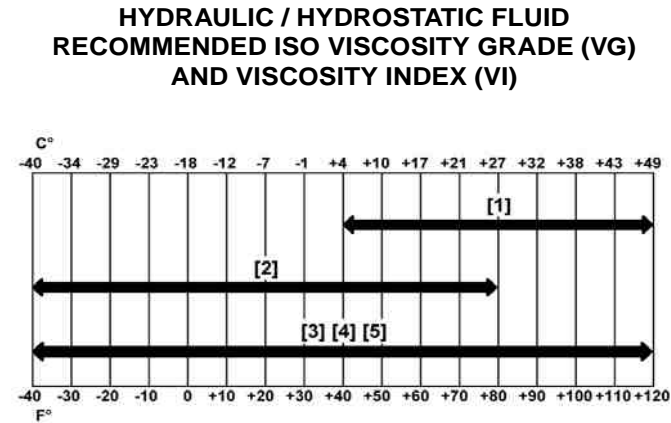

**TEMPERATURE RANGE ANTICIPATED
DURING MACHINE USE**

- [1] VG 100; Minimum VI 130
- [2] VG 46; Minimum VI 150
- [3] BOBCAT All-Season Fluid
- [4] BOBCAT Synthetic Fluid
- [5] BOBCAT Biodegradable Hydraulic / Hydrostatic Fluid (Unlike biodegradable fluids that are vegetable based, Bobcat biodegradable fluid is formulated to prevent oxidation and thermal breakdown at operating temperatures.)

Install the oil fill cap.

Removing And Replacing The Hydraulic Filters



AVOID INJURY OR DEATH

Always clean up spilled fuel or oil. Keep heat, flames, sparks or lighted tobacco away from fuel and oil. Failure to use care around combustibles can cause explosion or fire.

W-2103-0508

Hydraulic Filter

See the service schedule for the correct service interval. (See SERVICE SCHEDULE on Page 103.)

Open the tailgate. (See Opening And Closing on Page 109.)

Figure 196

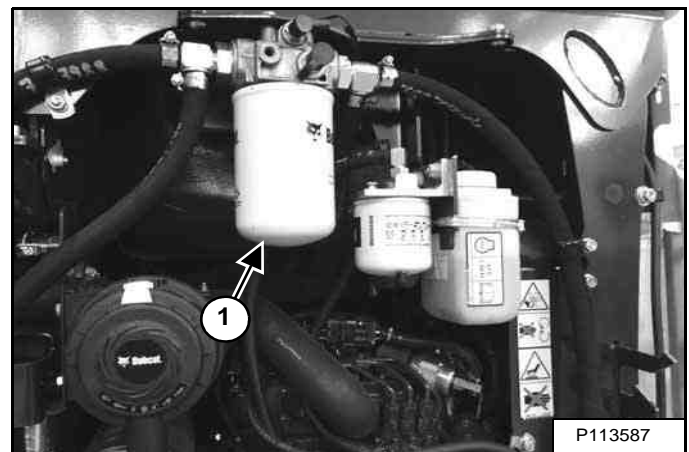

Remove the hydraulic filter (Item 1) [Figure 196].

Clean the housing where the filter gasket makes contact.

Put clean hydraulic fluid on the gasket. Install the new filter and hand tighten only. Use a genuine Bobcat replacement filter.



AVOID INJURY OR DEATH

Always clean up spilled fuel or oil. Keep heat, flames, sparks or lighted tobacco away from fuel and oil. Failure to use care around combustibles can cause explosion or fire.

W-2103-0508

HYDRAULIC SYSTEM (CONT'D)

Removing And Replacing The Hydraulic Fluid

See the service schedule for the correct service interval. (See SERVICE SCHEDULE on Page 103.)



AVOID INJURY OR DEATH

Diesel fuel or hydraulic fluid under pressure can penetrate skin or eyes, causing serious injury or death. Fluid leaks under pressure may not be visible. Use a piece of cardboard or wood to find leaks. Do not use your bare hand. Wear safety goggles. If fluid enters skin or eyes, get immediate medical attention from a doctor familiar with this injury.

W-2072-EN-0909

Retract the arm and bucket cylinders, lower the bucket to the ground. Stop the engine.

Open the tailgate. (See Opening And Closing on Page 109.)

Remove the left side cover [Figure 194].

Figure 197

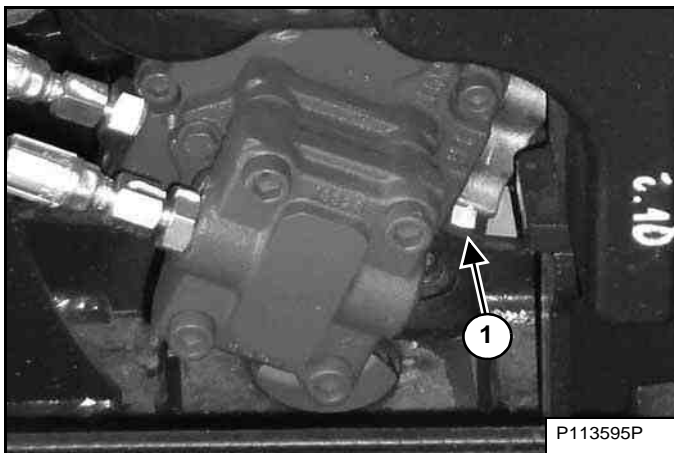

The hydraulic fluid drain plug (Item 1) [Figure 197] is located on the hydraulic pump inlet fitting.

Remove the plug (Item 1) [Figure 197].

Drain the fluid into a container.

Recycle or dispose of the fluid in an environmentally safe manner.

Install the plug (Item 1) [Figure 197].

Add fluid to the reservoir. (See Checking And Adding Hydraulic Fluid on Page 129.)

Figure 198

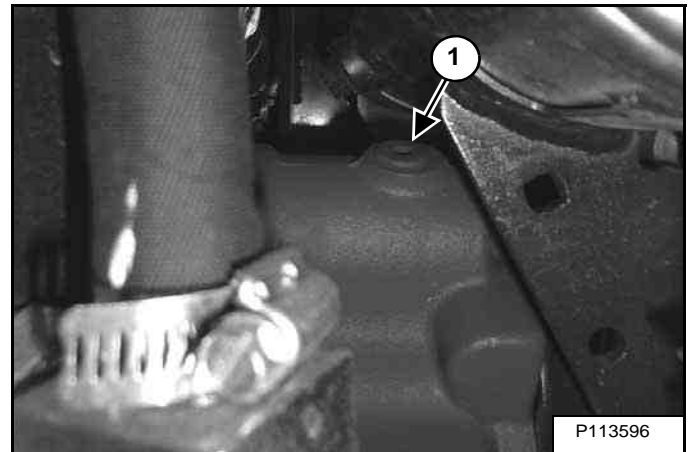

With the engine OFF, loosen the plug (Item 1) [Figure 198] on the hydraulic pump. Tighten the plug after a steady stream of hydraulic fluid, free of any air bubbles, drains from the plug. **DO NOT RUN THE MACHINE WITH THE PLUG OPEN.** Tighten the plug to 30 - 34 N•m (22 - 25 ft-lb) torque.

Figure 199

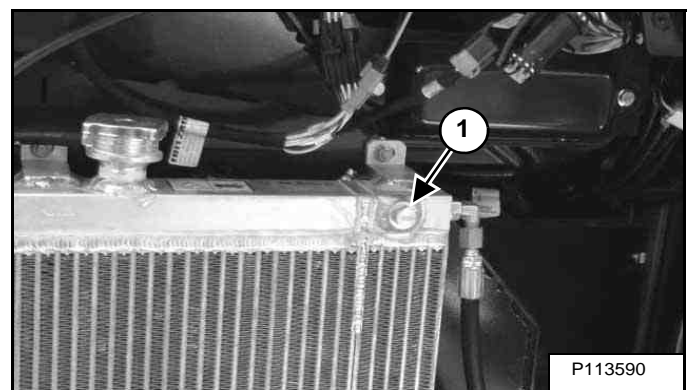

There is also a plug (Item 1) [Figure 199] on the hydraulic cooler for bleeding air. Install a container under the plug and slowly loosen the plug until hydraulic fluid, free of air seeps from the plug. Tighten the plug.

Recycle or dispose of the fluid in an environmentally safe manner.

Start the engine and operate the machine through the hydraulic functions. Stop the engine. Check the fluid level and add as needed.



SPARK ARRESTOR MUFFLER

Cleaning Procedure

See the SERVICE SCHEDULE for the correct service interval. (See SERVICE SCHEDULE on Page 103.)

! WARNING

AVOID INJURY OR DEATH

When an engine is running in an enclosed area, fresh air must be added to avoid concentration of exhaust fumes. If the engine is stationary, vent the exhaust outside. Exhaust fumes contain odorless, invisible gases which can kill without warning.

W-2050-0807

! WARNING

Stop engine and allow the muffler to cool before cleaning the spark chamber. Wear safety goggles. Failure to obey can cause serious injury.

W-2011-1285

! WARNING

Never use machine in atmosphere with explosive dust or gases or where exhaust can contact flammable material. Failure to obey warnings can cause injury or death.

W-2068-1285

! WARNING

When the engine is running during service, the steering levers must be in neutral.

Failure to do so can cause injury or death.

W-2203-0595

IMPORTANT

This machine is factory equipped with a spark arrester exhaust system.

The spark arrester muffler, if equipped, must be cleaned to keep it in working condition. The spark arrester muffler must be serviced by dumping the spark chamber every 100 hours of operation.

On some models, the turbocharger functions as the spark arrester and must operate correctly for proper spark arrester function.

If this machine is operated on flammable forest, brush, or grass covered land, a spark arrester attached to the exhaust system may be required and must be maintained in working order. Refer to local laws and regulations for spark arrester requirements.

I-2284-EN-0909

Do not operate the excavator with a defective exhaust system.

Stop the engine. Open the tailgate. (See TAILGATE on Page 109.)

Remove the left side cover.

SPARK ARRESTOR MUFFLER (CONT'D)

Cleaning Procedure (Cont'd)

Figure 200

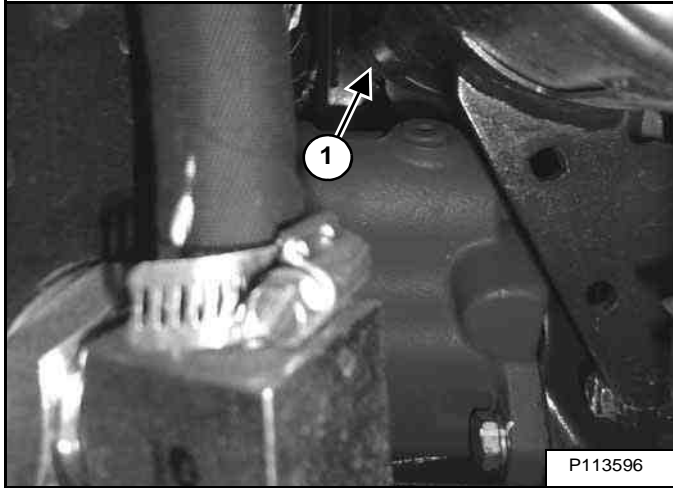

Remove the plug (Item 1) **[Figure 200]** from the bottom of the muffler.

Start the engine and run for about 10 seconds while a second person, wearing safety glasses, holds a piece of wood over the outlet of the muffler. The carbon deposits will be forced out of the muffler plug hole (Item 1) **[Figure 200]**.

Stop the engine. Install and tighten the plug.

Close the tailgate.

TRACK TENSION

Checking Tension

NOTE: The wear of the pins and bushings on the undercarriage vary with the working conditions and the different types of soil conditions. It is necessary to inspect track tension and maintain the correct tension. See service schedule for the correct service interval. (See **SERVICE SCHEDULE** on Page 103.)

Raise the side of the machine (approximately 102 mm [4 in]) using the boom and arm.

Figure 201

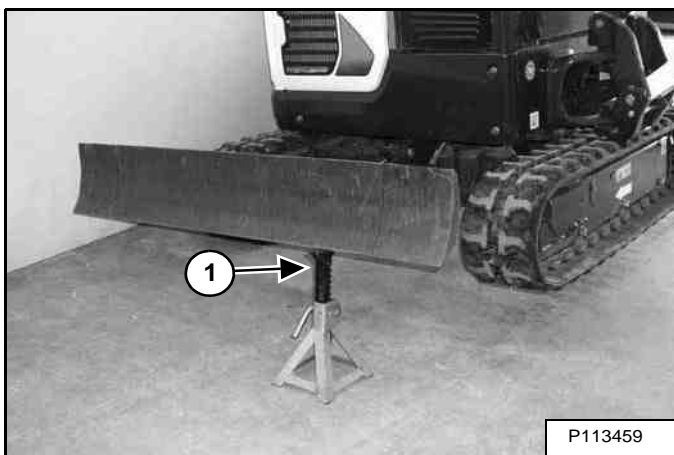
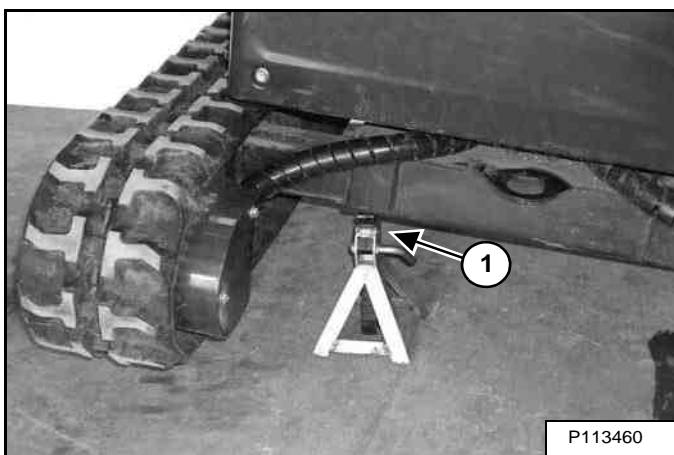

Figure 202



Raise the blade fully and install jackstands under the blade and track frame (Item 1) [Figure 201] and [Figure 202]. Raise the boom until all machine weight is on the jackstands.

Stop the engine.



AVOID INJURY

Keep fingers and hands out of pinch points when checking the track tension.

W-2142-0903

Track Clearance

Figure 203

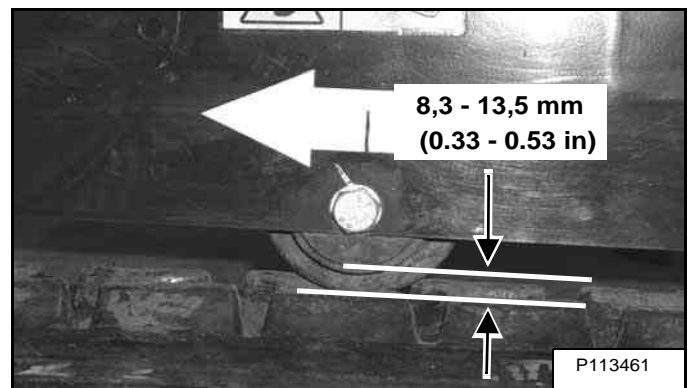
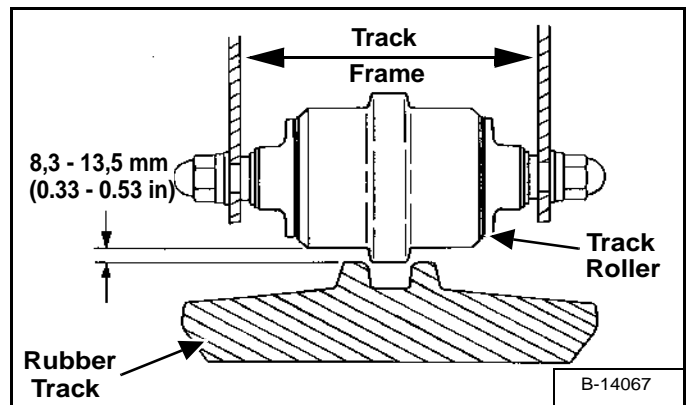

Figure 204



Measure the clearance at either middle track roller. Do not get fingers into pinch points between the track and the track roller. Use a bolt or a dowel of the appropriate size to check the gap between the contact edge of the roller and the top edge of the track guide [Figure 203] and [Figure 204].

Track Clearance	8,3 - 13,5 mm (0.33 - 0.53 in)
-----------------	-----------------------------------

TRACK TENSION (CONT'D)

Adjusting Tension

Figure 205

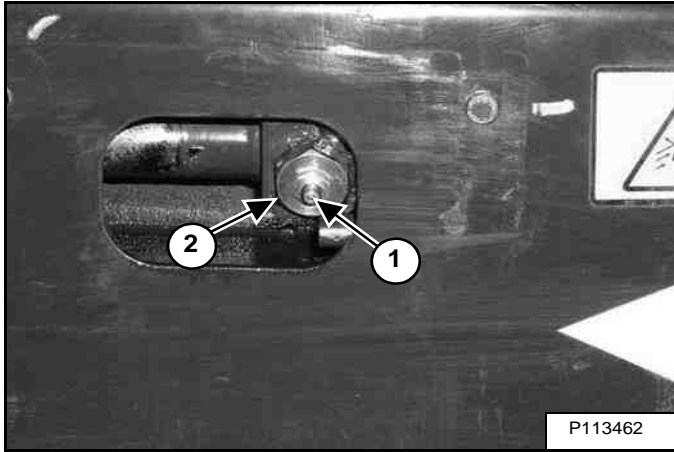

Loosen the access cover bolts and pivot the access cover open [Figure 205].

Increase Track Tension

Add grease to the fitting (Item 1) [Figure 205] until the track tension is correct.

Decrease Track Tension

WARNING

AVOID INJURY OR DEATH

If grease fitting is removed before pressure is released, the fitting can come off with great force and cause serious injury or death.

W-2490-0104

Pressure must be released from the grease cylinder to decrease track tension.

Loosen the bleed fitting (NOT the grease fitting) (Item 2) [Figure 205] and release pressure until the track tension is correct.

NOTE: DO NOT loosen the bleed fitting (Item 2) [Figure 205] for more than eight turns.

Tighten the bleed fitting to 80 - 100 N•m (59 - 74 ft-lb) torque.

Pivot the access cover closed and tighten the access cover bolts.

Raise the machine and remove the jackstands.

Repeat the procedure for the other side.

Dispose of grease in an environmentally safe manner.

TRAVEL MOTOR

Checking And Adding Oil

Figure 206

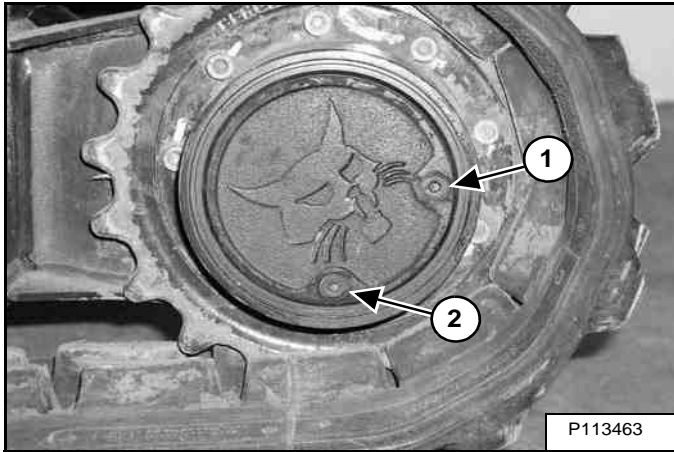

Park the excavator on a level surface with the plugs (Items 1 and 2) [Figure 206] in the position as shown.

Remove the plug (Item 1) [Figure 206]. The fluid level must be at the bottom edge of the hole.

Add lubricant (SAE 80W90) through the hole if the fluid level is low.

Removing And Replacing Oil

See the service schedule for the correct service interval. (See SERVICE SCHEDULE on Page 103.)

Park the excavator on a level surface with plugs (Items 1 and 2) [Figure 206] in the position shown. Remove both plugs and drain the lubricant into a container.

WARNING

AVOID INJURY OR DEATH

Always clean up spilled fuel or oil. Keep heat, flames, sparks or lighted tobacco away from fuel and oil. Failure to use care around combustibles can cause explosion or fire.

W-2103-0508

Install the bottom plug (Item 2) [Figure 206]. Add fluid through the centre plug hole until the fluid level is at the bottom edge of the hole.

Install the plug (Item 1) [Figure 206].

ALTERNATOR AND FAN BELT

Belt Adjustment

Stop the engine and open the tailgate. (See Opening And Closing on Page 109.)

Figure 207

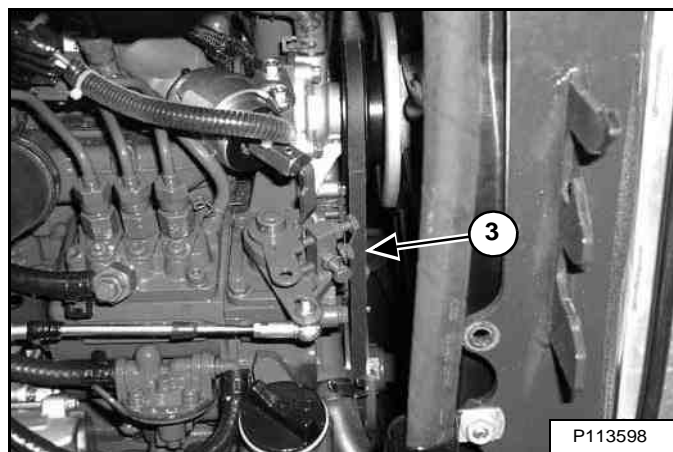
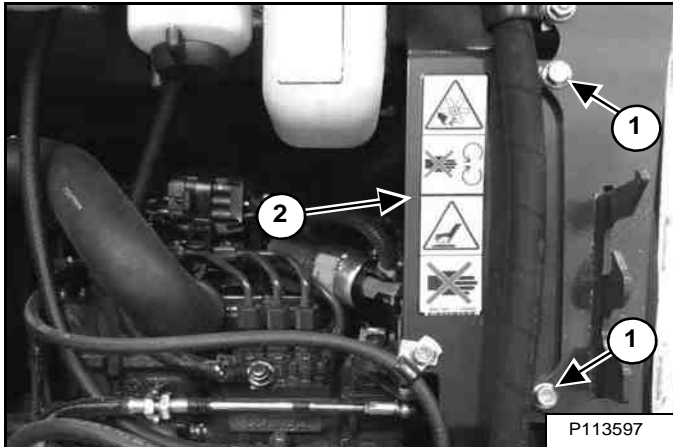

Remove the two bolts (Item 1) and reposition the belt guard (Item 2) [Figure 207] out of the way.

Measure the belt (Item 3) [Figure 207] tension at the middle of the belt span.

If a belt tension tool is available, the correct belt tension is; (new belt = 272 - 292 N [61 - 65 lbf] or used belt = 233 - 252 N [53 - 57 lbf]) tension.

If a belt tension tool is not available, the correct belt tension is; 8,0 mm (5/16 in) movement at the middle of the belt span with 66 N (15 lbf) of force.

Reinstall the belt guard (Item 2) and the two bolts (Item 1) [Figure 207].

Figure 208

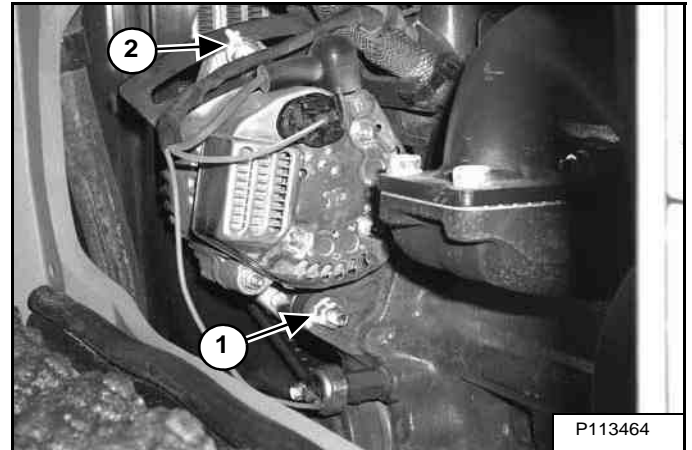

NOTE: The seat is shown removed for photo clarity. The storage box below the seat can be removed to access the engine from below the seat.

NOTE: The alternator adjusting bolts can be accessed by removing the belt guard (Item 2) [Figure 207] and reaching around the engine.

If the belt tension is not correct, loosen the bolt and nut (Item 1) and the bolt (Item 2) [Figure 208] until the alternator can be rotated for adjustment.

Adjust belt tension to correct specifications [Figure 207].

Tighten the mounting and adjustment bolts. Recheck the belt tension to confirm it did not change while tightening the alternator bolts.

Reinstall the belt guard (Item 2) [Figure 207].

Close the tailgate.

Belt Replacement

Loosen the bolt and nut (Item 1) and the bolt (Item 2) [Figure 208] until the alternator can be moved toward the engine.

Remove the old belt and install a new belt.

Adjust belt tension to correct specifications [Figure 207].

Tighten the mounting and adjustment bolts. Recheck the belt tension to confirm it did not change while tightening the alternator bolts.

Reinstall the belt guard (Item 2) [Figure 207].

Close the tailgate.

QUICK COUPLER

Bucket Link And Attachment Coupler Inspection And Maintenance

Figure 209

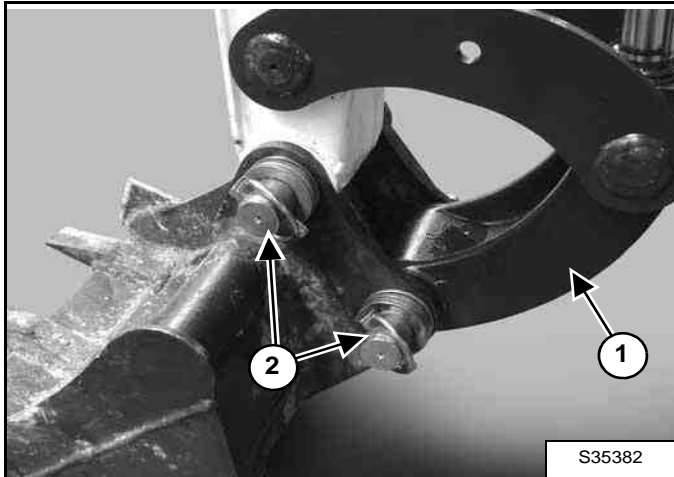

Inspect the bucket link (Item 1) for wear or damage. Inspect the attachment pins (Item 2) [Figure 209] for wear or damage.

Repair or replace damaged parts.

Figure 210

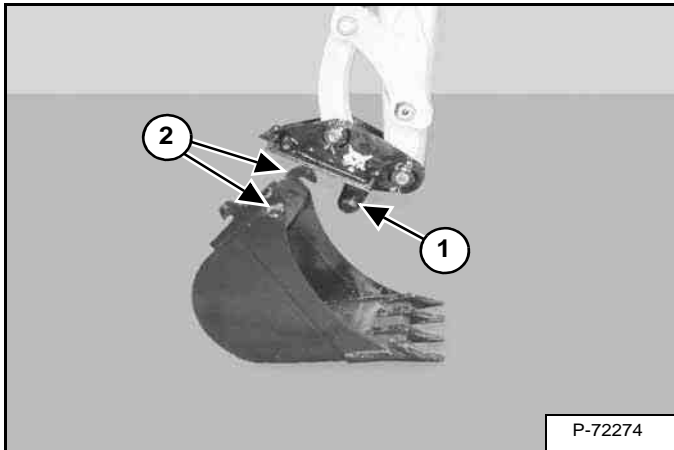

Inspect the quick coupler for wear or damage. Inspect the quick coupler pins (Item 1) and the hooks (Item 2) [Figure 210] (on the attachment) for wear or damage

Repair or replace damaged parts.

TRACK ROLLER AND IDLER LUBRICATION

Procedure

The track rollers and idlers require no maintenance. The bearings are a sealed design.

LUBRICATION OF THE HYDRAULIC EXCAVATOR

Lubrication Locations

Lubricate the excavator as specified in the service schedule for the best performance of the machine. (See SERVICE SCHEDULE on Page 103.)

Always use a good quality lithium based multipurpose grease when lubricating the machine. Apply the lubricant until extra grease shows.

Lubricate the following locations on the excavator **EVERY 8 - 10 HOURS**:

Figure 211

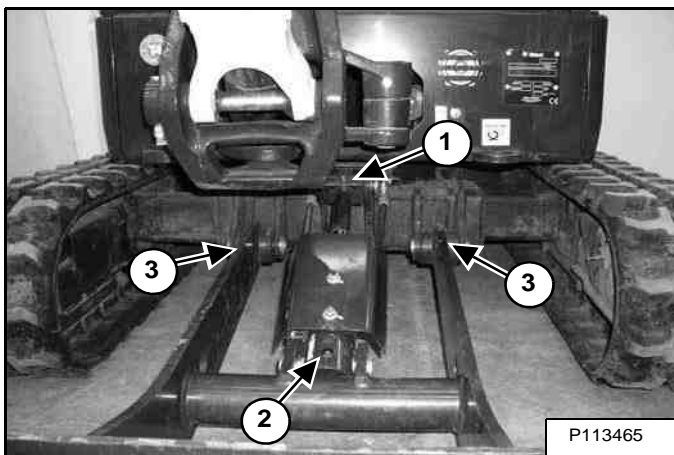

Ref Description (# of Fittings)

1. Blade Cylinder Rod End (1) [Figure 211]
2. Blade Cylinder Base End (1) [Figure 211]
3. Blade Pivots (2) [Figure 211]

Figure 212

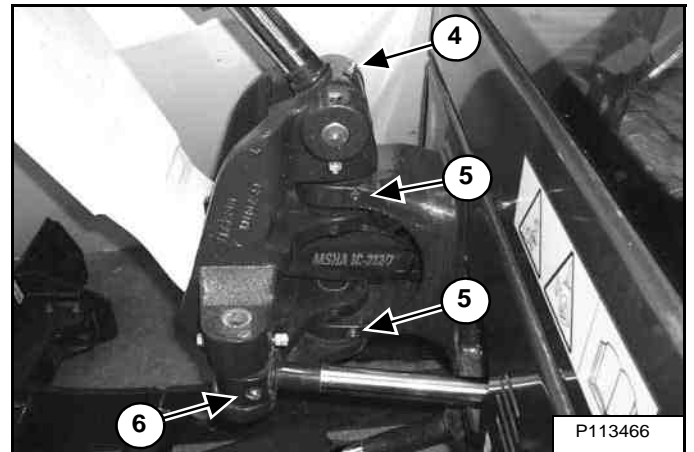

4. Boom Cylinder Rod End (1) [Figure 212]
5. Boom Swing Pivot (3) [Figure 212]
6. Boom Swing Cylinder Rod End (1) [Figure 212]

Figure 213

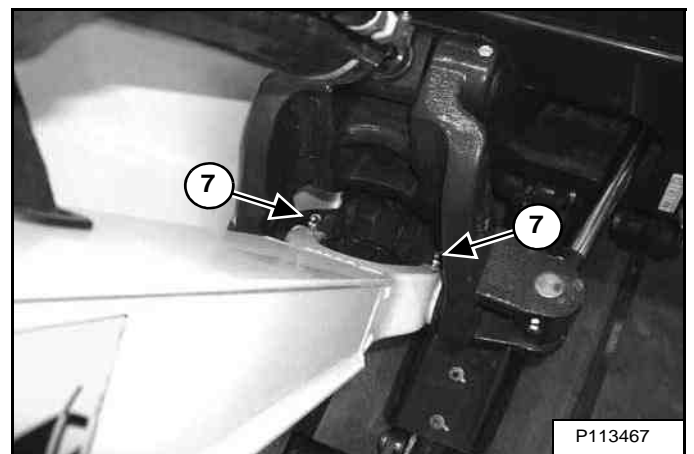

7. Boom Pivot (2) [Figure 213]

LUBRICATION OF THE HYDRAULIC EXCAVATOR (CONT'D)

Lubrication Locations (Cont'd)

Figure 214

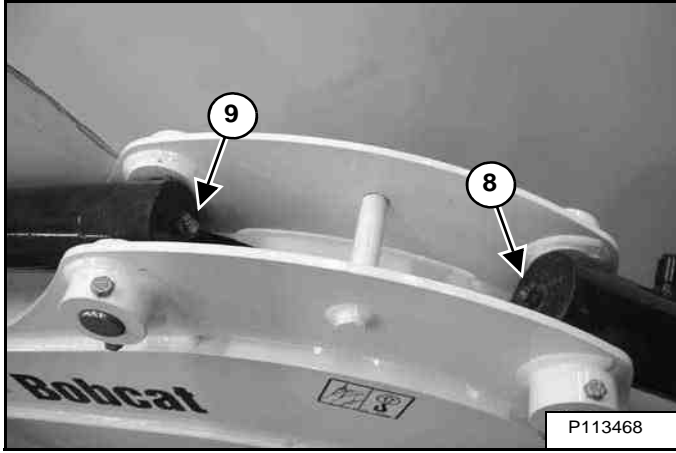

8. Boom Cylinder Base End (1) [Figure 214]

9. Arm Cylinder Base End (1) [Figure 214]

Figure 215

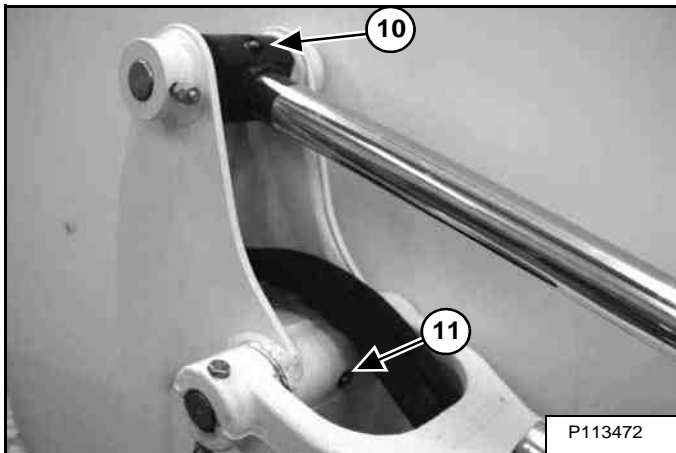

10. Arm Cylinder Rod End (1) [Figure 215]

11. Arm Pivot (1) [Figure 215]

Figure 216

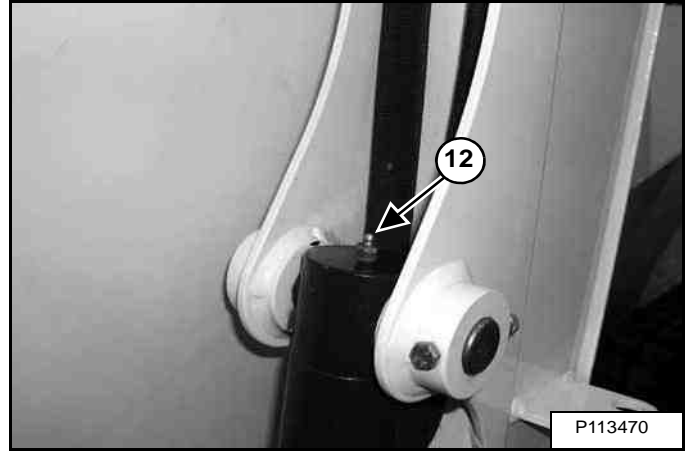

12. Bucket Cylinder Base End (1) [Figure 216]

Figure 217

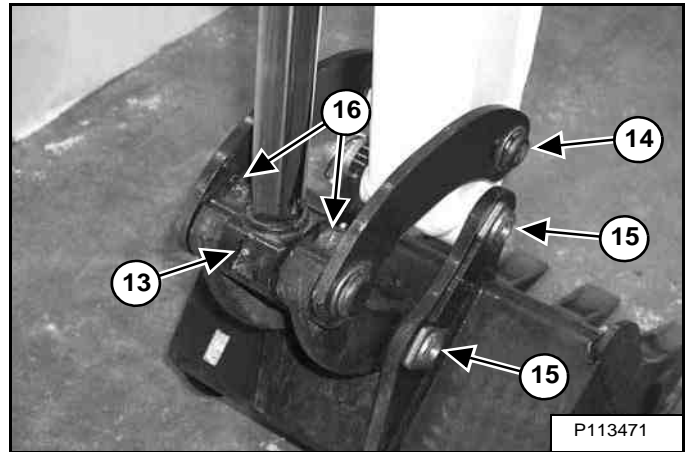

13. Bucket Cylinder Rod End (1) [Figure 217]

14. Bucket Link Pin (1) [Figure 217]

15. Bucket Pivot (2) [Figure 217]

16. Bucket Link (2) [Figure 217]

LUBRICATION OF THE HYDRAULIC EXCAVATOR (CONT'D)

Lubrication Locations (Cont'd)

Figure 218

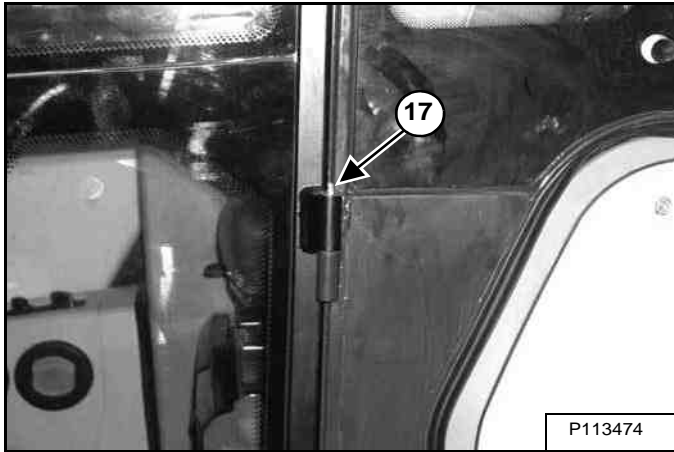

17. Cab Door hinges (3) **[Figure 218]** (If Equipped)

Figure 219

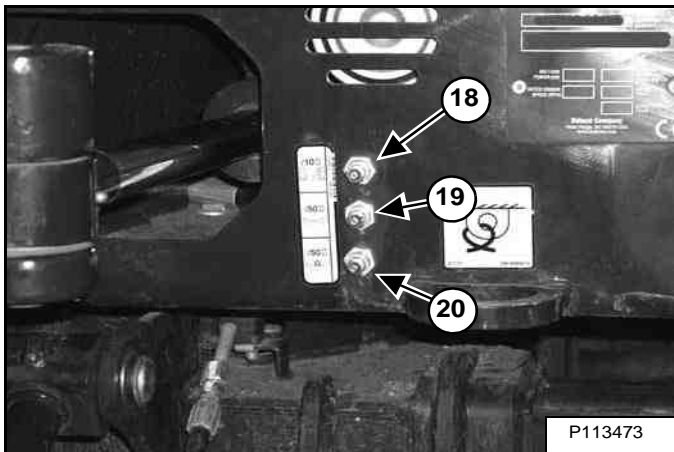

18. Boom Swing Cylinder Base (1) **[Figure 219]**

Lubricate the following locations on the hydraulic excavator **EVERY 50 HOURS**:

19. Slew Circle (1) **[Figure 219]**

20. Slew Pinion (1) **[Figure 219]**. (Install three to four pumps of grease then rotate the upperstructure 90°. Install three to four pumps of grease and again rotate the upperstructure 90°. Repeat this until the slew pinion has been greased at four positions.)

PIVOT PINS

Inspection And Maintenance

Figure 220

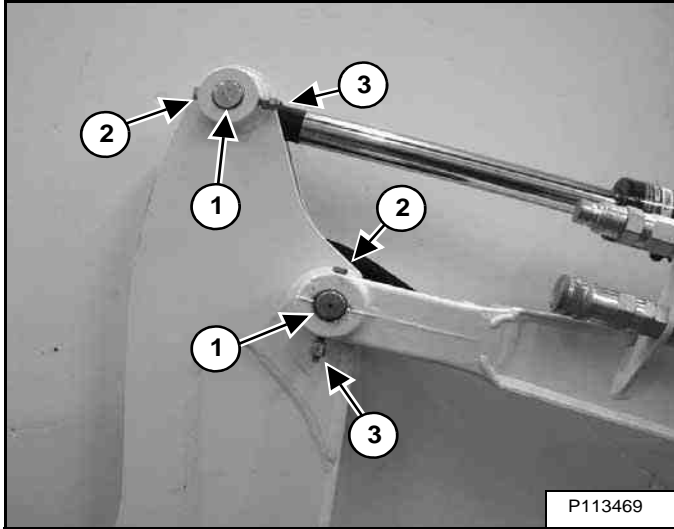

The pivots and cylinders (Item 1) have a large pin held in position with a bolt (Item 2) and double nuts (Item 3) [Figure 220] securing the pin.

The two nuts (Item 3) are used as jam nuts to hold the bolt (Item 2) without tightening the bolt (Item 2) to the pin boss. After the nuts (Item 3) are tightened together, the bolt (Item 2) [Figure 220] should be free to spin. See your Bobcat dealer for replacement parts.



EXCAVATOR STORAGE AND RETURN TO SERVICE

Storage

Sometimes it can be necessary to store your Bobcat excavator for an extend period of time. Below is a list of items to perform before storage.

- Thoroughly clean the excavator including the engine compartment.
- Lubricate the excavator.
- Replace worn or damaged parts.
- Drive the excavator onto planks in a dry protected shelter.
- Lower the boom fully with the bucket flat on the ground.
- Put grease on any exposed cylinder rods.
- Put fuel stabiliser in the fuel tank and run the engine a few minutes to circulate the stabiliser to the pump and fuel injectors.
- Drain and flush the cooling system. Refill with premixed coolant.
- Replace all fluids and filters (engine, hydraulic).
- Replace all filters (For example: air cleaner, heater, etc.).
- Put all controls in neutral position.
- Remove the battery. Be sure the electrolyte level is correct then charge the battery. Store it in a cool dry place above freezing temperatures and charge it periodically during storage.
- Cover the exhaust pipe opening.
- Tag the machine to indicate that it is in storage condition.

Return To Service

After the Bobcat excavator has been in storage, it is necessary to follow a list of items to return the excavator to service.

- Check the engine and hydraulic fluid levels; check coolant level.
- Install a fully charged battery.
- Remove grease from exposed cylinder rods.
- Check all belt tensions.
- Be sure all shields and guards are in place.
- Lubricate the excavator.
- Remove cover from exhaust pipe opening.
- Start the engine and let run for a few minutes while observing the instrument panels and systems for correct operation.
- Drive the excavator off of the planks.
- Operate machine, check for correct function.
- Stop the engine and check for leaks. Repair as needed.



Bobcat®



SYSTEM SETUP AND ANALYSIS

DIAGNOSTIC SERVICE CODES	147
Viewing Service Codes	147
Number Codes List	148
PASSWORD SETUP (KEYLESS START PANEL)	150
Password Description	150
Changing The Owner, User 1 and User 2 Password	150
Password Lockout Feature	151
PASSWORD SETUP (DELUXE INSTRUMENT PANEL)	152
Password Description	152
Changing The Owner Password	152
Changing The User Passwords	153
Password Lockout Feature	153
MAINTENANCE CLOCK	154
Description	154
Standard Instrument Panel	154
Setup	154
Reset	154



Bobcat®

DIAGNOSTIC SERVICE CODES

Viewing Service Codes

The Service Codes will aid your dealer in diagnosing conditions that can damage your machine.

Standard Instrument Panel

Figure 221



Press the Information button (Item 2) to cycle the data display (Item 1) [Figure 221] until the service code screen is displayed. If more than one service code is present, the codes will scroll on the data display.

When no service code is present, [NONE] is displayed [Figure 221].

NOTE: Corroded or loose earth can cause multiple service codes and / or abnormal symptoms. All instrument panel lights flashing, alarm sounding, headlights and taillights flashing, can indicate a bad earth. The same symptoms can apply if the voltage is low, such as loose or corroded battery cables. If you observe these symptoms, check earth and positive leads first.



DIAGNOSTIC SERVICE CODES (CONT'D)

Number Codes List

CODE		CODE	
L0102	Lights Button Error On	M1402	Fuel Pull Solenoid Error On
L0202	Auto Idle Button Error On	M1403	Fuel Pull Solenoid Error Off
L0302	Auxiliary Button Error On	M1407	Fuel Pull Solenoid Open Circuit
L0402	Information Button Error On		
L7404	Gateway Controller No Communication	M1605	Hydraulics Bypass Solenoid Short to Battery
L7672	Display Panel Programming Error	M1606	Hydraulics Bypass Solenoid Short to Ground
		M1607	Hydraulics Bypass Solenoid Open Circuit
M0216	Hydraulic Filter Not Connected	M1632	Hydraulics Bypass Solenoid Overcurrent
M0217	Hydraulic Filter Plugged		
		M1705	Hydraulics Enable Solenoid Short to Battery
M0309	Battery Voltage Low	M1706	Hydraulics Enable Solenoid Short to Ground
M0310	Battery Voltage High	M1707	Hydraulics Enable Solenoid Open Circuit
M0311	Battery Voltage Extremely High	M1732	Hydraulics Enable Solenoid Overcurrent
M0314	Battery Voltage Extremely Low		
M0322	Battery Voltage Out of Range Low	M1802	Power Beyond Relay Error On
		M1803	Power Beyond Relay Error Off
M0414	Engine Oil Pressure Extremely Low	M1807	Power Beyond Output Open Circuit
M0415	Engine Oil Pressure in Shutdown		
		M1902	PB Valve Relay Error On
M0610	Engine Speed High	M1903	PB Valve Relay Error Off
M0611	Engine Speed Extremely High		
M0613	Engine Speed No Signal	M2005	Two Speed Solenoid Short to Battery
M0615	Engine Speed Shutdown	M2006	Two Speed Solenoid Short to Ground
M0618	Engine Speed Out of Range	M2007	Two Speed Solenoid Open Circuit
M0810	Engine Coolant Temperature High	M2102	Glow Plug Output Error On
M0811	Engine Coolant Temperature Extremely High	M2103	Glow Plug Output Error Off
M0815	Engine Coolant Temperature Shutdown	M2107	Glow Plug Output Open Circuit
M0821	Engine Coolant Temperature Out of Range High	M2128	Glow Plug Output Failure
M0822	Engine Coolant Temperature Out of Range Low		
		M2202	Starter Output Error On
M0909	Fuel Level Low	M2203	Starter Output Error Off
M0921	Fuel Level Out of Range High	M2207	Starter Output Open Circuit
M0922	Fuel Level Out of Range Low		
		M2302	Starter Relay Error On
M1121	Console Sensor Out of Range High	M2303	Starter Relay Error Off
M1122	Console Sensor Out of Range Low		
M1128	Console Sensor Failure	M2402	Fuel Pull Relay Error On
		M2403	Fuel Pull Relay Error Off
M1305	Fuel Hold Solenoid Short to Battery		
M1306	Fuel Hold Solenoid Short to Ground	M2521	Load Sense Sensor Out of Range High
M1307	Fuel Hold Solenoid Open Circuit	M2522	Load Sense Sensor Out of Range Low



DIAGNOSTICS SERVICE CODE (CONT'D)

Number Codes List (Cont'd)

CODE		CODE	
M2521	Load Sense Sensor Out of Range High	M5605	Auxiliary Rod Solenoid Short to Battery
M2522	Load Sense Sensor Out of Range Low	M5606	Auxiliary Rod Solenoid Short to Ground
		M5607	Auxiliary Rod Solenoid Open Circuit
M2602	Glow Plug Relay Error On	M5632	Auxiliary Rod Solenoid Overcurrent
M2603	Glow Plug Relay Error Off		
		M5721	Auxiliary Control Switch Out of Range High
M3128	Interrupted Power Failure	M5722	Auxiliary Control Switch Out of Range Low
		M5724	Auxiliary Control Switch Out of Neutral
M4109	Alternator Low		
M4110	Alternator High	M6204	Load Moment Sensor In Error
		M6221	Load Moment Sensor Out of Range High
M4304	Keyless Start Panel No Communication	M6222	Load Moment Sensor Out of Range Low
M4404	Secondary Controller No Communication	M6402	Switched Power Relay Error On
		M6403	Switched Power Relay Error Off
M4621	5V Sensor Supply Out of Range High	M6407	Switched Power Relay Open Circuit
M4622	5V Sensor Supply Out of Range Low		
		M7002	Switched Power Output Error On
M4721	8V Sensor Supply Out of Range High	M7003	Switched Power Output Error Off
M4722	8V Sensor Supply Out of Range Low	M7007	Switched Power Output Open Circuit
		M7028	Switched Power Output Failure
M5002	Light Output Error On		
M5003	Light Output Error Off	M7423	Main Controller Not Programmed
		M7497	Main Controller Software Updated
M5205	Offset Base Solenoid Short to Battery		
M5206	Offset Base Solenoid Short to Ground	M7604	Standard Display Panel No Communication
M5207	Offset Base Solenoid Open Circuit		
M5232	Offset Base Solenoid Overcurrent	M7748	Key Switch Multiple
M5305	Offset Rod Solenoid Error On	M7839	Hourmeter Changed
M5306	Offset Rod Solenoid Short to Ground		
M5307	Offset Rod Solenoid Open Circuit	R7404	No Communication To Main Controller
M5332	Offset Rod Solenoid Overcurrent		
M5421	Offset Control Switch Out of Range High		
M5422	Offset Control Switch Out of Range Low		
M5424	Offset Control Switch Out of Neutral		
M5505	Auxiliary Base Solenoid Short to Battery		
M5506	Auxiliary Base Solenoid Short to Ground		
M5507	Auxiliary Base Solenoid Open Circuit		
M5532	Auxiliary Base Solenoid Overcurrent		

PASSWORD SETUP (KEYLESS START PANEL)

Password Description

Master Password:

A permanent, randomly selected password set at the factory that cannot be changed. This password is used for service by the Bobcat dealer if the owner password is not known or to change the owner password.

Owner Password:

Allows for full use of the excavator. Must be used to change the owner password, or User 1 / User 2 password.

User 1 and User 2 Passwords:

By default, User 1 and User 2 Passwords are not set.

NOTE: The User 1 and User 2 Password cannot be used to change a password or to switch between the Locked / Unlocked models.

Changing The Owner, User 1 and User 2 Password

Turn the start switch (Item 1) [Figure 222] to the ON position to turn on the excavators electrical system.

Enter the five digit owner password using the number keys (1 through 0) if locked.

Figure 222



Press and hold the lock (Item 2) and unlock (Item 3) [Figure 222] keys for 2 seconds.

The lock key red light or the unlock key green light will flash and the instrument panel display screen will show [CODE].

Enter a new five digit owner password using the number keys (1 through 0).

The display screen will show [OWNER] for two seconds. Press the unlock key (Item 3) [Figure 222] to navigate between [OWNER], [USER 1], and [USER 2].

After two seconds, the display screen will show [ENTER].

NOTE: The lock key (Item 2), red light and the unlock key (Item 3) [Figure 222], green light with flash during the procedure.

Enter a new five digit owner, user 1 or user 2 password using the number keys (1 through 0). An asterisk will show in the display screen for each key pass.

The display screen will show [AGAIN].

Enter the new five digit owner password again.

The display screen will show [ERROR] if:

- The second five digit owner, user 1 or user 2 password is different from the first one entered.
- or
- No number key was pressed for more than 20 seconds.
- or
- "00000" was entered as owner, user 1 or user 2 password.

NOTE: "00000" is not an acceptable owner, user 1 or user 2 password.

The system returns to its previous state. Either the lock key (Item 2), red light or the unlock key (Item 3) [Figure 222], green light will become solid.



**PASSWORD SETUP (KEYLESS START PANEL)
(CONT'D)**

Password Lockout Feature

This feature allows the owner to unlock the password feature so that a password does not need to be used every time the engine is started.

NOTE: The password lockout feature does not function with the user 1 or user 2 password.

Turn the start switch (Item 1) **[Figure 223]** to the ON position to turn on the excavators electrical system.

Enter the five digit owner password using the number keys (1 through 0).

Figure 223



Press the unlock key (Item 2) **[Figure 223]**.

The left panel display screen will show **[CODE]**.

Enter the five digit owner password using the number keys (1 through 0). The unlock key green light will flash, then become solid.

The excavator can now be started without using a password.

NOTE: Use the following procedure to reset the machine lock so that the excavator requires a password to start the engine.

Turn the start switch to the ON position to turn on the excavators electrical system.

Press the lock key (Item 3) **[Figure 223]**.

The lock key red light will flash and the left panel display screen will show **[CODE]**.

Enter the five digit owner password using the number keys (1 through 0). The unlock key green light will flash, then the lock key red light will become solid.

You must now enter the password every time to start the excavator.



PASSWORD SETUP (DELUXE INSTRUMENT PANEL)

Password Setup is available on machines with a Deluxe Instrument Panel.

Password Description

All new machines with a Deluxe Instrument Panel arrive at Bobcat dealerships with the keypad in locked mode. Locked mode means that a password must be used to start the engine.

For security purposes, your dealer may change the password and set the keypad in the locked mode. Your dealer will provide you with the password.

Master Password:

A permanent, randomly selected password set at the factory that cannot be changed. This password is used for service by the Bobcat dealer if the owner password is not known or to change the owner password.

Owner Password:

Allows for full use of the excavator and to set up the Deluxe Instrument Panel. There is only one owner password. The owner password must be used to change the owner or user passwords. Owner should change the password as soon as possible for security of the excavator.

User Password:

Allows starting and operating the excavator; cannot change password or any of the other setup features.

For the procedures to change passwords: (See Changing The Owner Password on Page 152.) and (See Changing The User Passwords on Page 153.)

Changing The Owner Password

	<p>Press a scroll button (Item 1) repeatedly until the Security screen icon (Inset) is highlighted.</p>
	<p>Select [1. PASSWORDS / LOCKOUTS].</p>
	<p>Enter owner password and press [ENTER].</p>
	<p>Select [1. USER SETTINGS].</p>
	<p>Select [1. OWNER].</p>
	<p>Select [2. CHANGE PASSWORD].</p>
	<p>Enter new owner password and press [ENTER]. You will be prompted to reenter the new owner password.</p>

PASSWORD SETUP (DELUXE INSTRUMENT PANEL) (CONT'D)

Changing The User Passwords

	<p>Press a scroll button (Item 1) repeatedly until the Security screen icon (Inset) is highlighted.</p>																														
	<p>Select [1. PASSWORDS / LOCKOUTS].</p>																														
	<p>Enter owner password and press [ENTER].</p>																														
	<p>Select [1. USER SETTINGS].</p>																														
<table border="1" data-bbox="98 1290 443 1509"> <thead> <tr> <th>NAME</th> <th>PASSWORD</th> <th>JOB CLOCK</th> </tr> </thead> <tbody> <tr> <td>1. SPENCER</td> <td>049881</td> <td>2.3</td> </tr> <tr> <td>2. TOMY</td> <td>-0123456789</td> <td>0000.0</td> </tr> <tr> <td>3. BRADY</td> <td>22222</td> <td>000.0</td> </tr> <tr> <td>4. NARY</td> <td>456789</td> <td>00.0</td> </tr> <tr> <td>5. AL</td> <td>01234</td> <td>400.0</td> </tr> <tr> <td>6. DEAN</td> <td>12345</td> <td>700.0</td> </tr> <tr> <td>7. MICHAEL</td> <td>98765</td> <td>100.0</td> </tr> <tr> <td>8. JOHN</td> <td>0000</td> <td>00.0</td> </tr> <tr> <td>9. TRAVIS</td> <td>0000</td> <td>00.0</td> </tr> </tbody> </table>	NAME	PASSWORD	JOB CLOCK	1. SPENCER	049881	2.3	2. TOMY	-0123456789	0000.0	3. BRADY	22222	000.0	4. NARY	456789	00.0	5. AL	01234	400.0	6. DEAN	12345	700.0	7. MICHAEL	98765	100.0	8. JOHN	0000	00.0	9. TRAVIS	0000	00.0	<p>Select user.</p>
NAME	PASSWORD	JOB CLOCK																													
1. SPENCER	049881	2.3																													
2. TOMY	-0123456789	0000.0																													
3. BRADY	22222	000.0																													
4. NARY	456789	00.0																													
5. AL	01234	400.0																													
6. DEAN	12345	700.0																													
7. MICHAEL	98765	100.0																													
8. JOHN	0000	00.0																													
9. TRAVIS	0000	00.0																													
	<p>Select [2. CHANGE PASSWORD].</p>																														
	<p>Enter new user password and press [ENTER].</p>																														

Password Lockout Feature

This feature allows the owner to unlock the password feature so that a password does not need to be used every time the engine is started.

	<p>Press a scroll button (Item 1) repeatedly until the Security screen icon (Inset) is highlighted.</p>
	<p>Select [1. PASSWORDS / LOCKOUTS].</p>
	<p>Enter owner password and press [ENTER].</p>
	<p>Select [2. MACHINE LOCK].</p>

NOTE: The procedure above can be followed to reset the machine lock so that the machine requires a password to start the engine.

NOTE: When the password is in UNLOCKED, no password is needed. The start switch is used to start the machine.

MAINTENANCE CLOCK

Description

The Maintenance Clock alerts the operator when the next service interval is due. *EXAMPLE:* The maintenance clock can be set to a 500 hour interval as a reminder for the next 500 hour planned maintenance.

Standard Instrument Panel

Figure 224

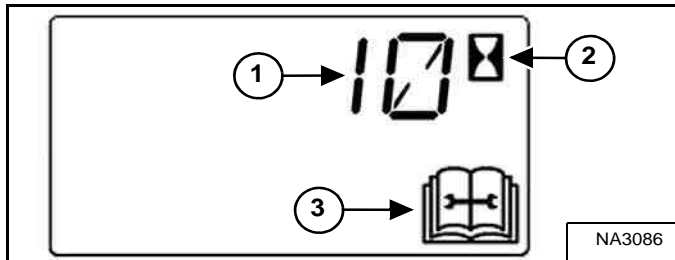

During machine operation, a 2 beep alarm will sound when there are less than 10 hours until the next planned maintenance.

The remaining hours before maintenance is required (Item 1) will appear in the data display for 5 seconds while the service icon (Item 3) and the hourmeter icon (Item 2) [Figure 224] flash.

NOTE: The display will show negative numbers after counting down to zero.

The display will revert to the previous display and will appear for 5 seconds every time the machine is started until the maintenance clock is reset.

Setup

See your Bobcat dealer about installation of this feature.

Reset

Figure 225



Press the Information button (Item 2) [Figure 225] until the display screen shows the maintenance clock.

Press and hold the Information button (Item 2) for 7 seconds until [RESET] (Item 1) [Figure 225] appears in the display screen.



SPECIFICATIONS

EXCAVATOR SPECIFICATIONS	157
Machine Dimensions	157
Rated Lift Capacity - Canopy	159
Rated Lift Capacity - Cab	160
Performance	161
Controls	161
Engine	162
Hydraulic System	162
Hydraulic Cylinders	163
Hydraulic Cycle Times	163
Electrical	163
Drive System	163
Slew System	164
Undercarriage	164
Capacities	164
Tracks	164
Ground Pressure	164
Environmental	165
Temperature Range	165



Bobcat®

EXCAVATOR SPECIFICATIONS

Machine Dimensions

- Where applicable, specification conform to SAE or ISO standards and are subject to change without notice.

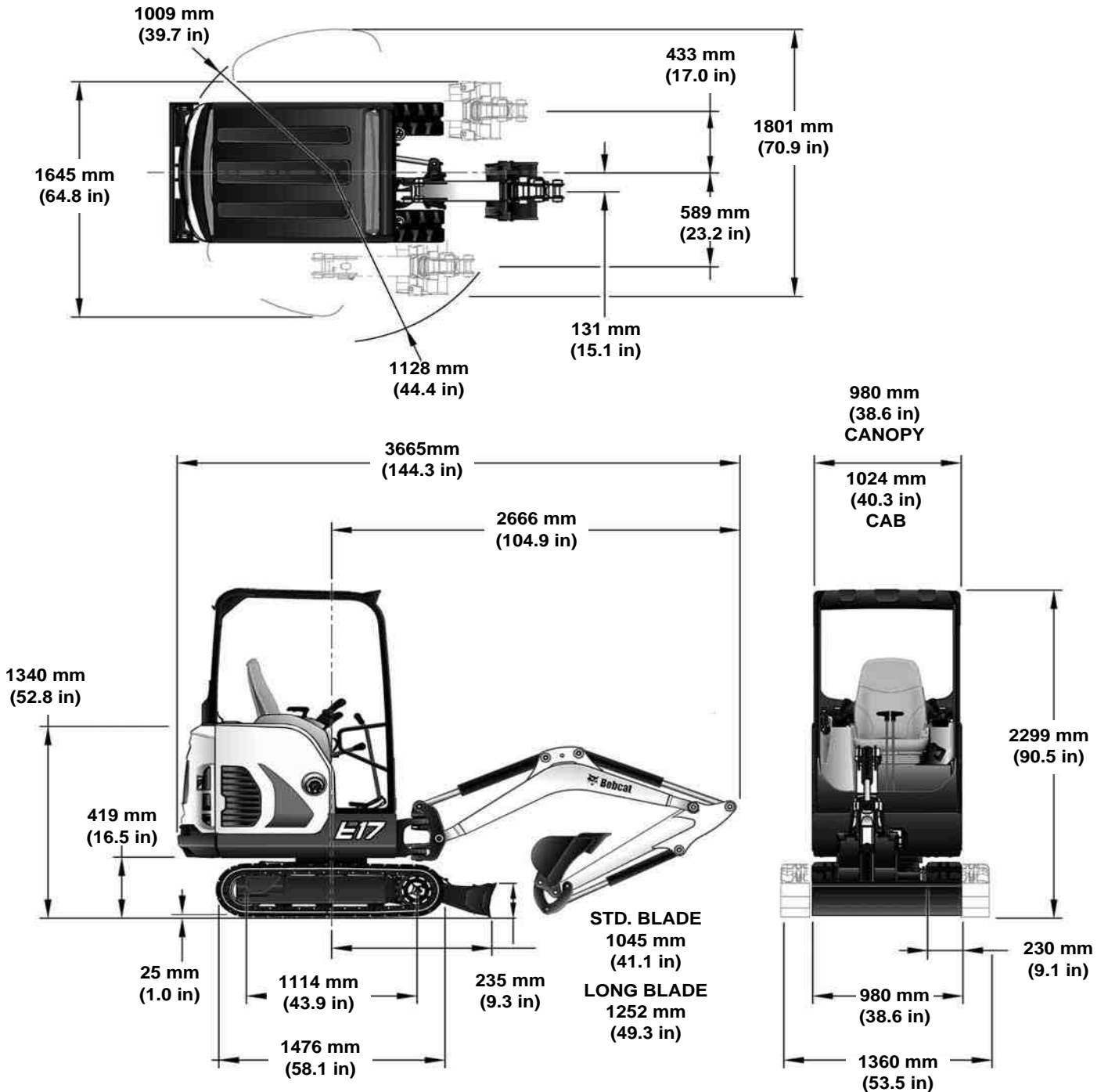

EXCAVATOR SPECIFICATIONS (CONT'D)

Machine Dimensions (Cont'd)

- Where applicable, specification conform to SAE or ISO standards and are subject to change without notice.

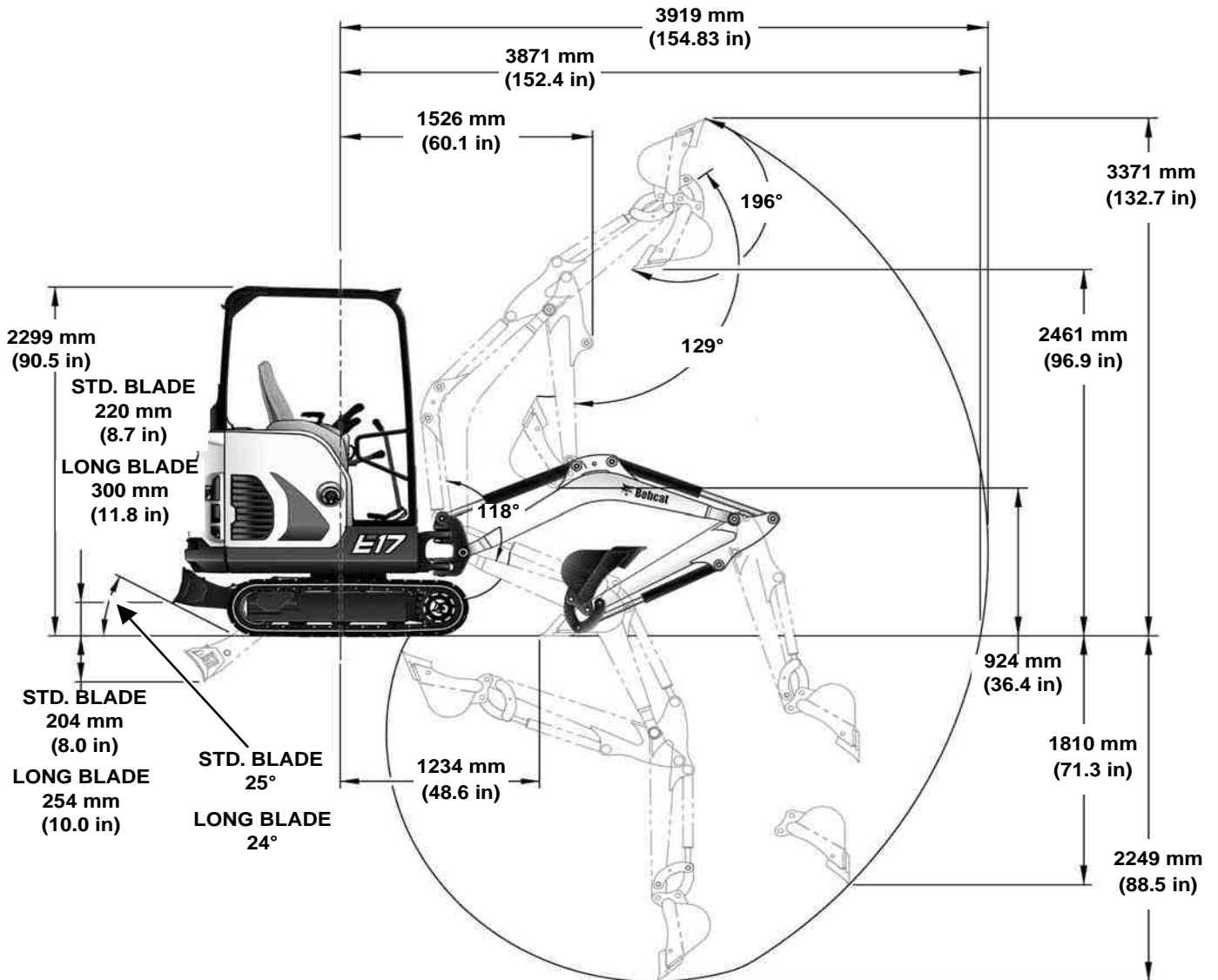



EXCAVATOR SPECIFICATIONS (CONT'D)

Rated Lift Capacity - Canopy

- Where applicable, specification conform to SAE or ISO standards and are subject to change without notice.

A	B		max. B		@	max. B
	2000 mm (79 in)	3000 mm (118 in)	2000 mm (79 in)	3000 mm (118 in)		
2000 mm (79 in)						180 kg @ 2960 mm (596 lb @ 117 in)
1000 mm (39 in)	*336 kg @ 2960 mm (740 lb @ 117 in)					304 kg @ 2960 mm (671 lb @ 117 in)
Ground	*330 kg @ 3338 mm (728 lb @ 131 in)	*448 kg (988 lb)	*448 kg (988 lb)	246 kg @ (542 lb)		246 kg @ 3338 mm (542 lb @ 131 in)
-1000 mm (-39 in)	*309 kg @ 2875 mm (681 lb @ 113 in)	*694 kg (1529 lb)	*409 kg (901 lb)	236 kg (521 lb)		241 kg @ 3310 mm (456 lb @ 130 in)
	*566 kg (1248 lb)	*694 kg (1529 lb)	*409 kg (901 lb)	415 kg (916 lb)		286 kg @ 2875 mm (631 lb @ 113 in)

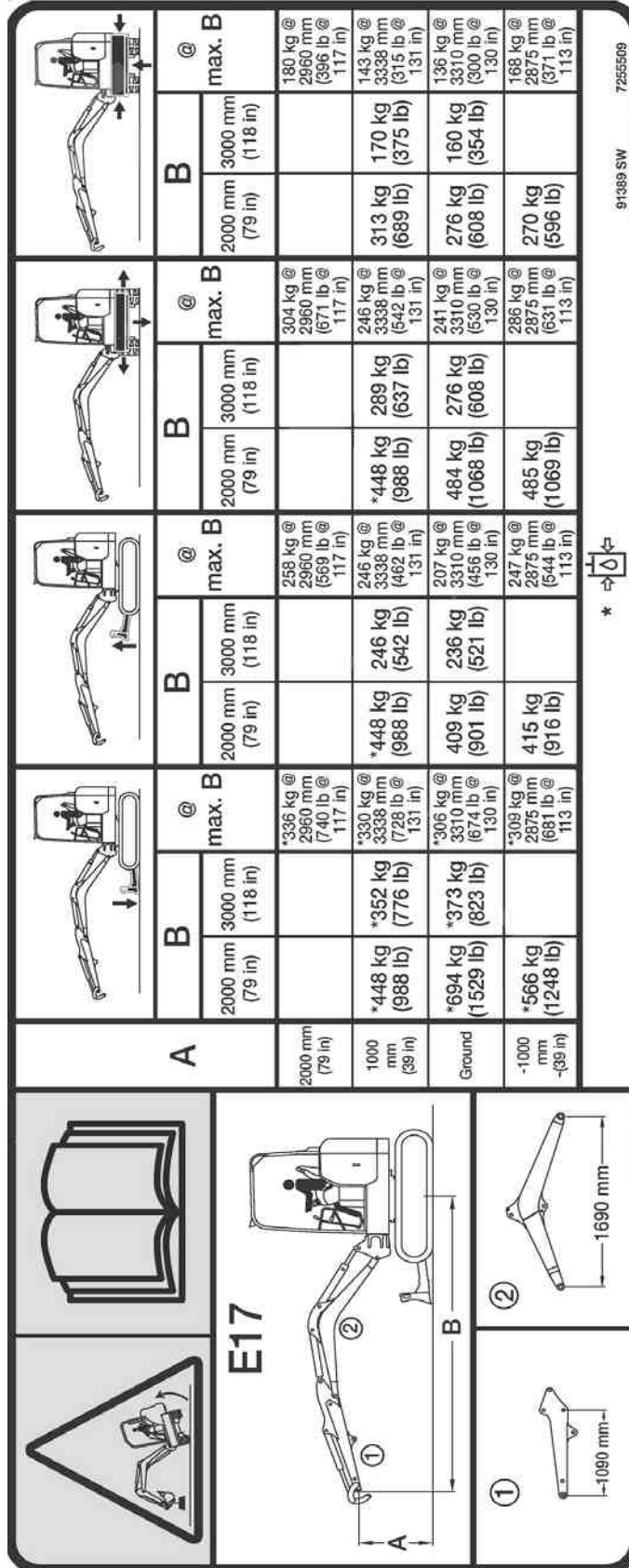

91389-SW
7255509

*



EXCAVATOR SPECIFICATIONS (CONT'D)

Rated Lift Capacity - Cab

- Where applicable, specification conform to SAE or ISO standards and are subject to change without notice.

A		B		B		B		B		B		B		B		B	
		2000 mm (79 in)	3000 mm (118 in)	2000 mm (79 in)	3000 mm (118 in)	2000 mm (79 in)	3000 mm (118 in)	2000 mm (79 in)	3000 mm (118 in)	2000 mm (79 in)	3000 mm (118 in)	2000 mm (79 in)	3000 mm (118 in)	2000 mm (79 in)	3000 mm (118 in)	2000 mm (79 in)	3000 mm (118 in)
2000 mm (79 in)	3000 mm (118 in)	*336 kg @ 2960 mm (740 lb @ 117 in)	330 kg @ 3338 mm (728 lb @ 131 in)	*306 kg @ 3310 mm (674 lb @ 130 in)	*309 kg @ 2875 mm (681 lb @ 113 in)	*448 kg (988 lb)	*352 kg (776 lb)	*694 kg (1529 lb)	*566 kg (1248 lb)	*448 kg (988 lb)	*448 kg (988 lb)	*448 kg (988 lb)	*448 kg (988 lb)	*448 kg (988 lb)	*448 kg (988 lb)	*448 kg (988 lb)	*448 kg (988 lb)
1000 mm (39 in)	Ground	1000 mm (39 in)	Ground	Ground	Ground	170 kg (375 lb)	313 kg (689 lb)	170 kg (375 lb)	313 kg (689 lb)	170 kg (375 lb)	313 kg (689 lb)	170 kg (375 lb)	313 kg (689 lb)	170 kg (375 lb)	313 kg (689 lb)	170 kg (375 lb)	313 kg (689 lb)
180 kg @ 2960 mm (396 lb @ 117 in)	143 kg @ 3338 mm (315 lb @ 131 in)	136 kg @ 3310 mm (300 lb @ 130 in)	168 kg @ 2875 mm (371 lb @ 113 in)	304 kg @ 2960 mm (671 lb @ 117 in)	246 kg @ 3338 mm (542 lb @ 131 in)	241 kg @ 3310 mm (530 lb @ 130 in)	286 kg @ 2875 mm (631 lb @ 113 in)	258 kg @ 2960 mm (569 lb @ 117 in)	210 kg @ 3338 mm (462 lb @ 131 in)	207 kg @ 3310 mm (456 lb @ 130 in)	247 kg @ 2875 mm (544 lb @ 113 in)	241 kg @ 2960 mm (530 lb @ 117 in)	246 kg @ 3338 mm (542 lb @ 131 in)	241 kg @ 3310 mm (530 lb @ 130 in)	286 kg @ 2875 mm (631 lb @ 113 in)	258 kg @ 2960 mm (569 lb @ 117 in)	210 kg @ 3338 mm (462 lb @ 131 in)

* 91389 SW 7255508

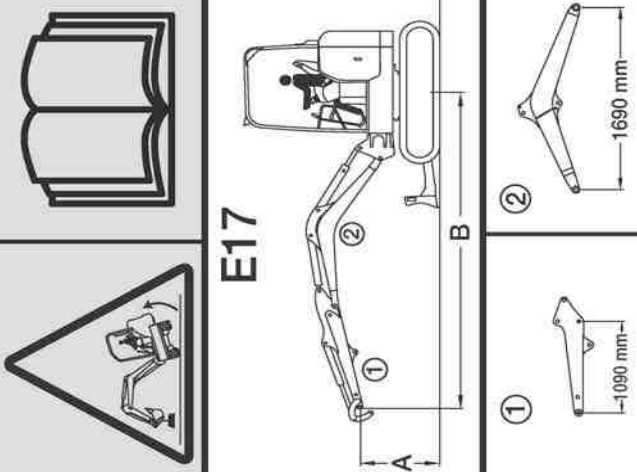

7255508



EXCAVATOR SPECIFICATIONS (CONT'D)

Performance

Operating weight (canopy w/ rubber tracks, counterweight, basic seat and standard bucket)	1711 kg (3772 lb)
If equipped with the following, add:	Cab w/ Heater, add 96 kg (211 lb); Long Blade, add 9 kg (20 lb) Additional Counter Weight, add 50 kg (110 lb) Standard Seat, add 8 kg (18 lb) Suspension Seat, add 14 kg (30 lb)
Maximum Approved Attachment Weight	350 kg (772 lb)
Travel Speed (Low / High)	2,0 km/h / 3,2 km/h (1.2 mph / 2.0 mph)
Digging Force (per ISO 6015)	
With Standard Arm	Arm - 9108 N (2048 lb) Bucket - 16177 N (3637 lb)

Controls

Steering	Two hand levers (optional foot pedals)
Hydraulics	Two hand operated levers (joysticks) control boom, bucket, arm and upperstructure slew
Blade	Hand lever
Two Speed	Switch on blade lever
Boom Swing	Electric switch in left joystick or R.H. foot pedal
Auxiliary Hydraulics	Electric switch in right joystick or L.H. foot pedal
Auxiliary Pressure Release	Electric switch in right joystick or L.H. foot pedal
Engine	Engine speed control lever, key type start switch
Starting Aid	Glow Plugs - activated by key switch
Brakes	
Travel	
Service and Parking	Hydraulic lock in motor circuit
Slew	
Service	Hydraulic lock on motor
Holding	Spring applied - hydraulic release



EXCAVATOR SPECIFICATIONS (CONT'D)

Engine

Make / Model	Kubota D722-E2B-BCZ-7 Tier II
Fuel / Cooling	Diesel NO.2-D / Liquid
Horsepower (SAE Net) @ 2500 rpm	9,9 kW (13,3 hp)
Torque @ 2000 rpm (SAE)	42,3 N•m (31.9 ft-lb)
Number Of Cylinders	3
Displacement	0,719 L (43.9 in ³)
Bore / Stroke	67 x 68 mm (2.64 x 2.68 in)
Lubrication	Forced Lubrication / Cartridge type
Crankcase Ventilation	Closed breathing
Air Cleaner	Dual dry replacement paper elements
Ignition	Diesel-Compression
Low Idle Speed	1200 ± 50 rpm
High Idle Speed	2650 ± 20 rpm
Engine Coolant	Propylene Glycol / water mixture (53% PG / 47% water)

Hydraulic System

Pump Type	Engine driven, dual outlet, variable displacement, load sensing, torque limited, piston pump with gear pump
Pump Capacity Piston Pump Gear Pump	2 x 11,25 L/min (2 x 2.97 U.S. gpm) 10,0 L/min (2.64 U.S. gpm)
Auxiliary Flow Standard Flow	32,5 L/min (8.58 U.S. gpm)
Hydraulic Filter	Full flow replaceable, 3 micron synthetic media element
Control Valve	9 spool, parallel series type, open centre.
System Relief Pressure Blade	20600 kPa (206 bar) (2987 psi)
Slew Relief Pressure	16900 kPa (169 bar) (2451 psi)
Boom Swing, Boom Arm, Bucket, and Travel	23097 kPa (231 bar) (3350 psi)
Joystick Control Pressure	3103 kPa (31 bar) (450 psi)
Auxiliary Relief	17995 kPa (180 bar) (2610 psi)
Arm Port Relief Base And Rod End	24994 kPa (250 bar) (3625 psi)
Boom Port Relief Base End, Boom Port Relief Rod End	21000 kPa (210 bar) (3046 psi) 24994 kPa (250 bar) (3625 psi)
Bucket Port Relief Base And Rod End	24994 kPa (250 bar) (3625 psi)
Blade Port Relief Base End and Track Expansion Port Relief Base End	29000 kPa (290 bar) (4206 psi)
Main Hydraulic Filter Bypass	345 kPa (3,4 bar) (50 psi)



EXCAVATOR SPECIFICATIONS (CONT'D)

Hydraulic Cylinders

Cylinder	Bore	Rod	Stroke
Boom (cushion up)	63,5 mm (2.5 in)	38,1 mm (1.50 in)	438,9 mm (17.3 in)
Arm (cushion retract / extend)	57,1 mm (2.25 in)	38,1 mm (1.50 in)	419,9 mm (16.63 in)
Bucket	50,8 mm (2.0 in)	38,1 mm (1.50 in)	385,0 mm (15.16 in)
Boom Swing	60,3 mm (2.375 in)	31,8 mm (1.25 in)	411,2 mm (16.19 in)
Blade	57,1 mm (2.25 in)	31,8 mm (1.25 in)	107,9 mm (4.25 in)
Track Expansion	44,5mm (1.75 in)	25,4 mm (1.00 in)	385,0 mm (15.16 in)

Hydraulic Cycle Times

Bucket Curl	2,10 seconds
Bucket Dump	1,33 seconds
Arm Retract	2,86 seconds
Arm Extend	1,84 seconds
Boom Raise	4,60 seconds
Boom Lower	3,82 seconds
Boom Swing Left (80°)	3,40 seconds
Boom Swing Right (60°)	3,70 seconds
Blade Raise	1,65 seconds
Blade Lower	1,80 seconds
Track Expand	4,10 seconds
Track Retract	3,50 seconds

Electrical

Starting Aid	Glow Plugs
Alternator	12 volt, 40 Amp open frame w/ internal regulator
Battery	12 volt - 530 CCA @ -18°C (0°F)
Starter	12 volt; gear reduction 1,4 kW (1.4 hp)
Instrumentation	Fuel gauge, audible alarm, visual warning for engine functions and hourmeter
Lights	
Work Lights	65 watt (2)
Boom Light (If Equipped)	35 watt

Drive System

Final Drive	Each track is driven by hydrostatic axial piston motor
Drive Reduction	23,04:1 two stage planetary
Gradeability	30°
Brakes	Hydraulic lock on motor
Maximum Drawbar Pull	14334 N (3339 lbf)



EXCAVATOR SPECIFICATIONS (CONT'D)

Slew System

Slew Drive	Orbital motor, direct drive
Slew Circle	Single row shear type ball bearings with internal gear
Gear Reduction	21.5:1
Brake	Spring applied, pressure released
Slew Speed	8,7 rpm

Undercarriage

Crawler Track Design With Expandable Undercarriage	Sealed track rollers with boxed section track roller frame, grease type track adjuster with shock absorbing recoil spring
Width of crawler - Retracted	980 mm (38.6 in)
Width of crawler - Expanded	1360 mm (53.5 in)

Capacities

Fuel Tank	19,0 L (5.0 U.S. gal)
Hydraulic Reservoir Only (Centre of Sight Glass)	Tank Cap. 14,3 L (3.78 U.S. gal)
Hydraulic System (with Reservoir)	17,0 L (4.5 U.S. gal)
Cooling System	3,3 L (0.87 U.S. gal)
Engine Oil and Filter	3,3 L (3.5 qt)
Final Drive (each)	0,4 L (0.11 qt)

Tracks

Type	Rubber
Width	230 mm (9.0 in)
Number Of Shoes	Single Assembly
Number of Track Rollers (per side)	3

Ground Pressure

Rubber Tracks	29,4 kPa (0,294 bar) (4.26 psi)
---------------	---------------------------------



EXCAVATOR SPECIFICATIONS (CONT'D)

Environmental

DECLARED SINGLE-NUMBER NOISE EMISSION VALUES In accordance with ISO 4871	
Noise level per Directive 2000/14/EC - L_{WA}	93 dB
Operator noise level per Directive 2006/42/EC — L_{pA}	79 dB

DECLARED VIBRATION EMISSION VALUES In accordance with EN 12096		
	Value	Uncertainty
Whole-body vibration per ISO 2631-1	0,74 m/s^2	0,37 m/s^2
Hand-arm vibration per ISO 5349-1	1,42 m/s^2	---

Temperature Range

Operation and storage	-17° - +43°C (-1.3° - +109.4°F)
-----------------------	---------------------------------



Bobcat®



WARRANTY

WARRANTY 169



Bobcat®

WARRANTY

WARRANTY

BOBCAT EXCAVATORS

DOOSAN BENELUX S.A. warrants to its authorised dealers who in turn warrant to the end-user / owner, that each new Bobcat excavator will be free from proven defects in material and workmanship for twelve months from the date of delivery to the end-user / owner or 2000 hours of machine usage, whichever occurs first, with the exception of tracks which are covered for the same initial period on a pro-rated basis based on the remaining depth of the track at the time any defect is discovered,

During the warranty period, the authorised selling Bobcat dealer shall repair or replace, at DOOSAN BENELUX S.A.'s option, without charge for parts, labour and travel time of mechanics, any part of the Bobcat product which fails because of defects in material and workmanship. The end-user / owner shall provide the authorised dealer with prompt written notice of the defect and allow reasonable time for replacement or repair. DOOSAN BENELUX S.A. may, at its option, request failed parts to be returned to the factory. Transportation of the Bobcat product to the authorised Bobcat Excavator dealer for warranty work is the responsibility of the end-user / owner.

Service schedules must be adhered to, documented and genuine parts / lubricants must be used. The warranty does not cover oils and lubricants, coolant fluids, filter elements, tune-up parts, bulbs, fuses, ignition system parts (glow plugs, fuel injection pumps, injectors), alternator fan belts, drive belts and other high-wear items. Pins and bushings are considered to be normal consumable items and are not warranted.

The warranty does not cover damages resulting from abuse, accidents, alterations, use of the Bobcat product with any bucket or attachment not approved by Bobcat, air flow obstructions, or failure to maintain or use the Bobcat product according to the instructions applicable to it.

DOOSAN BENELUX S.A. EXCLUDES OTHER CONDITIONS, WARRANTIES OR REPRESENTATIONS OF ALL KINDS, EXPRESSED OR IMPLIED, STATUTORY OR OTHERWISE (EXCEPT THAT OF TITLE) INCLUDING ALL IMPLIED WARRANTIES AND CONDITIONS RELATING TO MERCHANTABILITY, SATISFACTORY QUALITY AND FITNESS FOR A PARTICULAR PURPOSE.

CORRECTIONS BY DOOSAN BENELUX S.A. OF NONCONFORMITIES WHETHER PATENT OR LATENT, IN THE MANNER AND FOR THE TIME PERIOD PROVIDED ABOVE, SHALL CONSTITUTE FULFILMENT OF ALL LIABILITIES OF DOOSAN BENELUX S.A. FOR SUCH NONCONFORMITIES, WHETHER BASED ON CONTRACT, WARRANTY, TORT, NEGLIGENCE, INDEMNITY, STRICT LIABILITY OR OTHERWISE WITH RESPECT TO OR ARISING OUT OF SUCH PRODUCT.

THE REMEDIES OF THE END-USER / OWNER SET FORTH UNDER THE PROVISIONS OF THE WARRANTY OUTLINED ABOVE ARE EXCLUSIVE AND THE TOTAL LIABILITY OF DOOSAN BENELUX S.A. INCLUDING ANY HOLDING, SUBSIDIARY, ASSOCIATED OR AFFILIATED COMPANY OR DISTRIBUTOR WITH RESPECT TO THIS SALE OR THE PRODUCT AND SERVICE FURNISHED HEREUNDER IN CONNECTION WITH THE PERFORMANCE OR BREACH THEREOF, OR FROM DELIVERY, INSTALLATION, REPAIR OR TECHNICAL DIRECTION COVERED BY OR FURNISHED UNDER THIS SALE, WHETHER BASED ON CONTRACT, WARRANTY, TORT, NEGLIGENCE, INDEMNITY, STRICT LIABILITY OR OTHERWISE SHALL NOT EXCEED THE PURCHASE PRICE OF THE PRODUCT UPON WHICH SUCH LIABILITY IS BASED.

DOOSAN BENELUX S.A. INCLUDING ANY HOLDING, SUBSIDIARY, ASSOCIATED OR AFFILIATED COMPANY AND DISTRIBUTOR SHALL IN NO EVENT BE LIABLE TO THE END-USER / OWNER, ANY SUCCESSORS IN INTEREST OR ANY BENEFICIARY OR ASSIGNEE RELATING TO THIS SALE FOR ANY CONSEQUENTIAL, INCIDENTAL, INDIRECT, SPECIAL OR PUNITIVE DAMAGES ARISING OUT OF THIS SALE OR BY ANY BREACH THEREOF, OR ANY DEFECT IN, OR FAILURE OF, OR MALFUNCTION OF THE PRODUCT UNDER THIS SALE, WHETHER BASED UPON LOSS OF USE, LOST PROFITS OR REVENUE, INTEREST, LOST GOODWILL, WORK STOPPAGE, IMPAIRMENT OF OTHER GOODS, LOSS BY REASON OF SHUTDOWN OR NON-OPERATION, INCREASED EXPENSES OF OPERATION OR CLAIMS OF USER OR CUSTOMERS OF THE USER FOR SERVICE INTERRUPTION WHETHER OR NOT SUCH LOSS OR DAMAGE IS BASED ON CONTRACT, WARRANTY, TORT, NEGLIGENCE, INDEMNITY, STRICT LIABILITY OR OTHERWISE.





Bobcat®



ALPHABETICAL INDEX

AIR CLEANER SERVICE	112	PASSWORD SETUP (DELUXE INSTRUMENT PANEL)	152
ALTERNATOR AND FAN BELT	137	PASSWORD SETUP (KEYLESS START PANEL)	150
ARM LOAD HOLDING VALVE	61	PIVOT PINS	142
ATTACHMENTS	73	PRE-STARTING PROCEDURE	65
BLADE CONTROL LEVER	55	PUBLICATIONS AND TRAINING RESOURCES	21
BOBCAT COMPANY IS ISO 9001 CERTIFIED	9	QUICK COUPLER	138
BOOM LOAD HOLDING VALVE	59	REGULAR MAINTENANCE ITEMS	9
BOOM SWING	58	RIGHT SIDE COVER	110
CAB FILTERS	111	SAFETY INSTRUCTIONS	17
CONTROL CONSOLE LOCKOUTS	105	SEAT BELT	106
DAILY INSPECTION	64	SERIAL NUMBER LOCATIONS	11
DECLARATION OF CONFORMITY	7	SERVICE SCHEDULE	103
DELIVERY REPORT	11	SPARK ARRESTOR MUFFLER	132
DIAGNOSTIC SERVICE CODES	147	STARTING THE ENGINE	68
ELECTRICAL SYSTEM	123	STOPPING THE ENGINE AND LEAVING THE EXCAVATOR	72
EMERGENCY EXIT	47	TAILGATE	109
ENGINE COOLING SYSTEM	120	TOWING THE EXCAVATOR	95
ENGINE LUBRICATION SYSTEM	118	TRACK FRAME RETRACTION - EXPANSION	56
ENGINE SPEED CONTROL	55	TRACK ROLLER AND IDLER LUBRICATION	138
EXCAVATOR IDENTIFICATION	12	TRACK TENSION	134
EXCAVATOR SPECIFICATIONS	157	TRANSPORTING THE EXCAVATOR ON A TRAILER	97
EXCAVATOR STORAGE AND RETURN TO SERVICE	143	TRAVEL CONTROLS	49
FEATURES, ACCESSORIES AND ATTACHMENTS	13	TRAVEL MOTOR	136
FIRE PREVENTION	19	WARRANTY	169
FUEL SYSTEM	114		
HYDRAULIC CONTROLS	51		
HYDRAULIC SYSTEM	129		
INSTRUMENTS AND CONSOLES	33		
LIFTING THE EXCAVATOR	96		
LUBRICANTS AND FLUIDS	10		
LUBRICATION OF THE HYDRAULIC EXCAVATOR	139		
MACHINE SIGNS (DECALS)	22		
MAINTENANCE CLOCK	154		
MAINTENANCE SAFETY	101		
MONITORING THE DISPLAY PANELS	71		
MOTION ALARM SYSTEM	107		
MOTION ALARM SYSTEM	48		
OPERATING PROCEDURE	82		
OPERATOR CAB (ROPS / TOPS)	41		
OPERATOR CANOPY (ROPS / TOPS)	41		
OPERATOR SAFETY WARNING	1		
OVERLOAD WARNING DEVICE	63		



Bobcat®



