



Bobcat®

EN

Operation & Maintenance Manual S650 Skid-Steer Loader

S/N A3NW11001 & Above

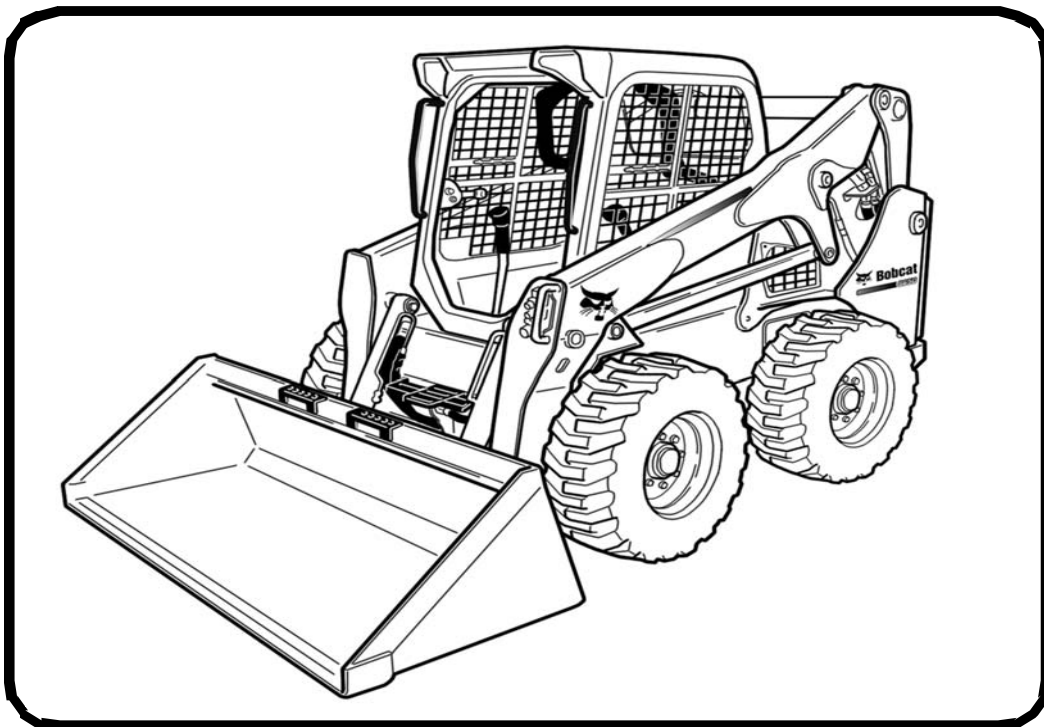

EQUIPPED WITH
BOBCAT INTERLOCK
CONTROL SYSTEM (BICS™)

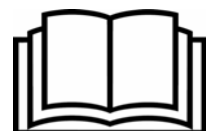





OPERATOR SAFETY WARNINGS

WARNING

Operator must have instructions before operating the machine. Untrained operators can cause injury or death.

W-2001-0502

CORRECT

P-90216

⚠ Never use the loader without instructions. See machine signs (decals), Operation & Maintenance Manual, and Operator's Handbook.

⚠ **Safety Alert Symbol:** This symbol with a warning statement, means: "Warning, be alert! Your safety is involved!" Carefully read the message that follows.

CORRECT

NA1254

⚠ Always use the seat bar and fasten seat belt snugly.
⚠ Always keep feet on the foot pedals or footrests when operating loader.

CORRECT

NA1673

⚠ Never use loader without operator cab with ROPS and FOPS approval. Fasten your seat belt.

WRONG

NA1696

⚠ Never use loader as man lift or elevating device for personnel.

WRONG

NA1671

⚠ Do not use loader in atmosphere with explosive dust, explosive gas, or where exhaust can contact flammable material.

WRONG

NA1698

⚠ Never carry riders.
⚠ Keep bystanders away from work area.

WRONG

NA1675

⚠ Always carry bucket or attachments as low as possible.
⚠ Do not travel or turn with lift arms up.
⚠ Load, unload, and turn on flat level ground.

WRONG

NA1676A

⚠ Never exceed Rated Operating Capacity.

WRONG

NA1672

⚠ Never leave loader with engine running or with lift arms up.
⚠ To park, engage parking brake and put attachment flat on the ground.

WRONG

NA1677

⚠ Never modify equipment.
⚠ Use only attachments approved by Bobcat Company for this model loader.

SAFETY EQUIPMENT

The Bobcat Loader must be equipped with safety items necessary for each job. Ask your dealer for information on the safe use of attachments and accessories.

1. SEAT BELT: Check belt fasteners and check for damaged webbing or buckle.
2. SEAT BAR: When up, it must lock the loader controls.
3. OPERATOR CAB (ROPS and FOPS): It must be on the loader with all fasteners tight.
4. OPERATOR'S HANDBOOK: Must be in the cab.
5. SAFETY SIGNS (DECALS): Replace if damaged.
6. SAFETY TREADS: Replace if damaged.
7. GRAB HANDLES: Replace if damaged.
8. LIFT ARM SUPPORT DEVICE: Replace if damaged.
9. PARKING BRAKE
10. BOBCAT INTERLOCK CONTROL SYSTEM (BICS)

OSW68-0609



Bobcat®



CONTENTS

FOREWORD	5
SAFETY & TRAINING RESOURCES	17
OPERATING INSTRUCTIONS	37
PREVENTIVE MAINTENANCE	125
SYSTEM SETUP & ANALYSIS	185
SPECIFICATIONS	199
WARRANTY	207
ALPHABETICAL INDEX	211

REFERENCE INFORMATION

Write the correct information for YOUR Bobcat loader in the spaces below. Always use these numbers when referring to your Bobcat loader.

Loader Serial Number _____
Engine Serial Number _____

NOTES:

YOUR BOBCAT DEALER:

ADDRESS:

PHONE:



Bobcat Company
P.O. Box 128
Gwinner, ND 58040-0128
UNITED STATES OF AMERICA

Doosan Benelux SA
Drève Richelle 167
B-1410 Waterloo
BELGIUM



Bobcat®



FOREWORD

This Operation & Maintenance Manual was written to give the owner / operator instructions on the safe operation and maintenance of the Bobcat loader. READ AND UNDERSTAND THIS OPERATION & MAINTENANCE MANUAL BEFORE OPERATING YOUR BOBCAT LOADER. If you have any questions, see your Bobcat dealer. This manual may illustrate options and accessories not installed on your loader.

DECLARATION OF CONFORMITY	7
BOBCAT COMPANY IS ISO 9001 CERTIFIED	9
REGULAR MAINTENANCE ITEMS	9
LUBRICANTS AND FLUIDS	10
SERIAL NUMBER LOCATIONS	11
Loader Serial Number	11
Engine Serial Number	11
DELIVERY REPORT	11
LOADER IDENTIFICATION	12
FEATURES, ACCESSORIES AND ATTACHMENTS	13
Standard Items	13
Options And Accessories	13
Buckets Available	14
Attachments	14
High-Flow Attachments	14
Special Applications Kit	15
Special Applications Kit Inspection And Maintenance	15



Bobcat®



DECLARATION OF CONFORMITY

Contents of EC Declaration of Conformity

This information is provided in the operators manual to comply with clause 1.7.4.2(c) of Annex I of Machinery Directive 2006/42/EC.

The official EC Declaration of Conformity is supplied in a separate document.

<p>Manufacturer</p>  <p>Bobcat®</p> <p>Bobcat Company World Headquarters 250 East Beaton Drive West Fargo, ND 58078-6000 UNITED STATES OF AMERICA</p>	<p>Directive 2000/14/EC: Noise Emission in the Environment by Equipment For Use Outdoors</p> <p>Notified Body Technical and Test Institute for Construction Prague, Czech Republic Notified Body Number: 1020</p>				
<p>Technical Documentation Doosan Benelux SA Drève Richelle 167 B-1410 Waterloo BELGIUM</p>	<p>EC Certificate No. 1020-090-022395</p> <p>Conformity Assessment Procedure(s) 2000/14/EC, Annex VIII, Full Quality Assurance</p> <p>Sound Power Levels [Lw(A)]</p> <table data-bbox="836 1126 1513 1189"> <tr> <td>Measured Sound Power</td> <td style="text-align: right;">99 dBA</td> </tr> <tr> <td>Guaranteed Sound Power</td> <td style="text-align: right;">101 dBA</td> </tr> </table>	Measured Sound Power	99 dBA	Guaranteed Sound Power	101 dBA
Measured Sound Power	99 dBA				
Guaranteed Sound Power	101 dBA				
<p>Description of Equipment Type of Equipment: Wheeled Loader Model Name: S650 Model Code: A3NW Lot Series: 11001</p> <p>Engine Manufacturer: Kubota Engine Model: V3307-DI-T-EU3 Engine Power: 54,6 kW @ 2400 RPM</p>	<p>Equipment conforms to CE Directive(s) Listed Below 2006/42/EC: Machinery Directive 2004/108/EC: Electromagnetic Compatibility Directive</p>				
<p>Declaration of Conformance This equipment conforms to the requirements specified in all the EC Directives listed in this declaration.</p>					
<p>Effective From:</p> <p>25 May 2010</p>					



Bobcat®



BOBCAT COMPANY IS ISO 9001 CERTIFIED











ISO 9001 is an international standard that specifies requirements for a quality management system that controls the processes and procedures which we use to design, develop, manufacture and distribute Bobcat products.

British Standards Institute (**BSI**) is the Certified Registrar Bobcat Company chose to assess the Company's compliance with the ISO 9001 at Bobcat's manufacturing facilities in Gwinner and Bismarck, North Dakota (U.S.A.), Pontchateau (France), Dobris (Czech Republic) and the Bobcat corporate offices (Gwinner, Bismarck & West Fargo) in North Dakota. Only certified assessors, like BSI, can grant registrations.

ISO 9001 means that as a company we say what we do and do what we say. In other words, we have established procedures and policies, and we provide evidence that the procedures and policies are followed.

REGULAR MAINTENANCE ITEMS

	ENGINE OIL FILTER (6 Pack) 6678233		BATTERY 6665427
	FUEL FILTER 6667352		HYDRAULIC FILTER 7012314
	AIR FILTER, Outer 7008043		HYDRAULIC CHARGE FILTER 6692337
	AIR FILTER, Inner 7008044		HYDRAULIC FILL / BREATHER CAP 6727475

NOTE: Always verify Part Numbers with your Bobcat dealer.

SERIAL NUMBER LOCATIONS

Always use the serial number of the loader when requesting service information or when ordering parts. Early or later models (identification made by serial number) may use different parts, or it may be necessary to use a different procedure in doing a specific service operation.

Loader Serial Number

Figure 1

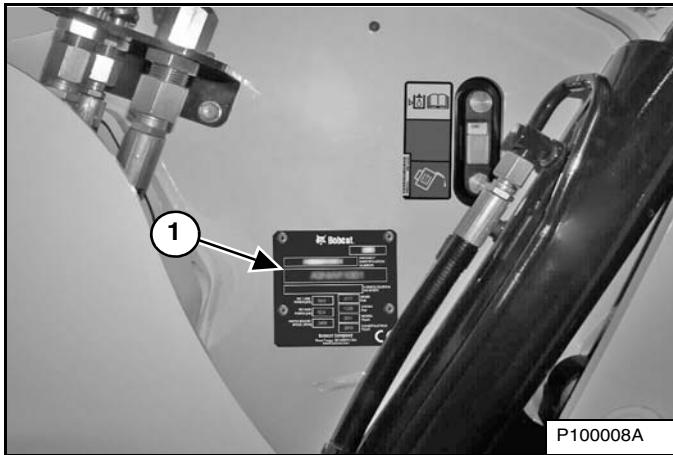

The loader serial number plate (Item 1) [Figure 1] is located on the outside of the loader frame.

Figure 2

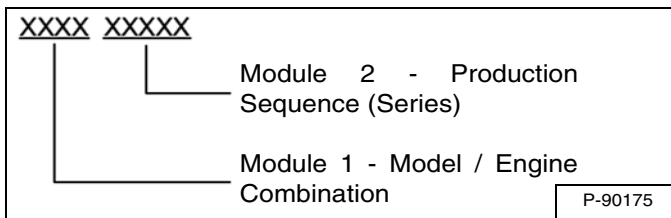

Explanation of loader Serial Number [Figure 2]:

1. The four digit Model / Engine Combination Module number identifies the model number and engine combination.
2. The five digit Production Sequence Number identifies the order which the loader is produced.

Engine Serial Number

Figure 3

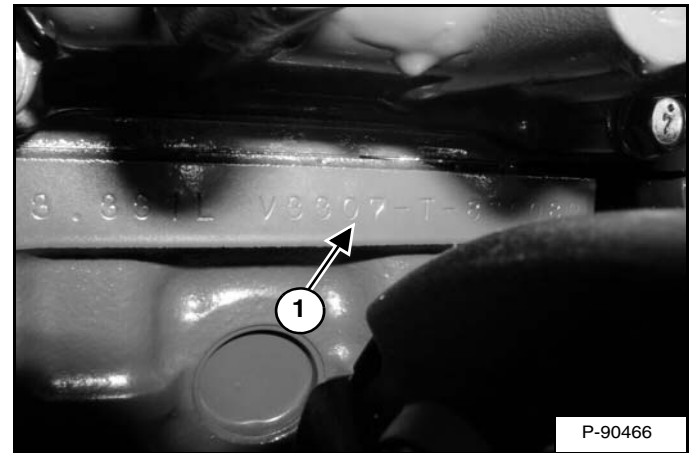

The engine serial number is located on the side of the engine (Item 1) [Figure 3] behind the alternator.

DELIVERY REPORT

Figure 4

The delivery report [Figure 4] must be completed by the dealer and signed by the owner or operator when the Bobcat loader is delivered. An explanation of the form must be given to the owner.



LOADER IDENTIFICATION

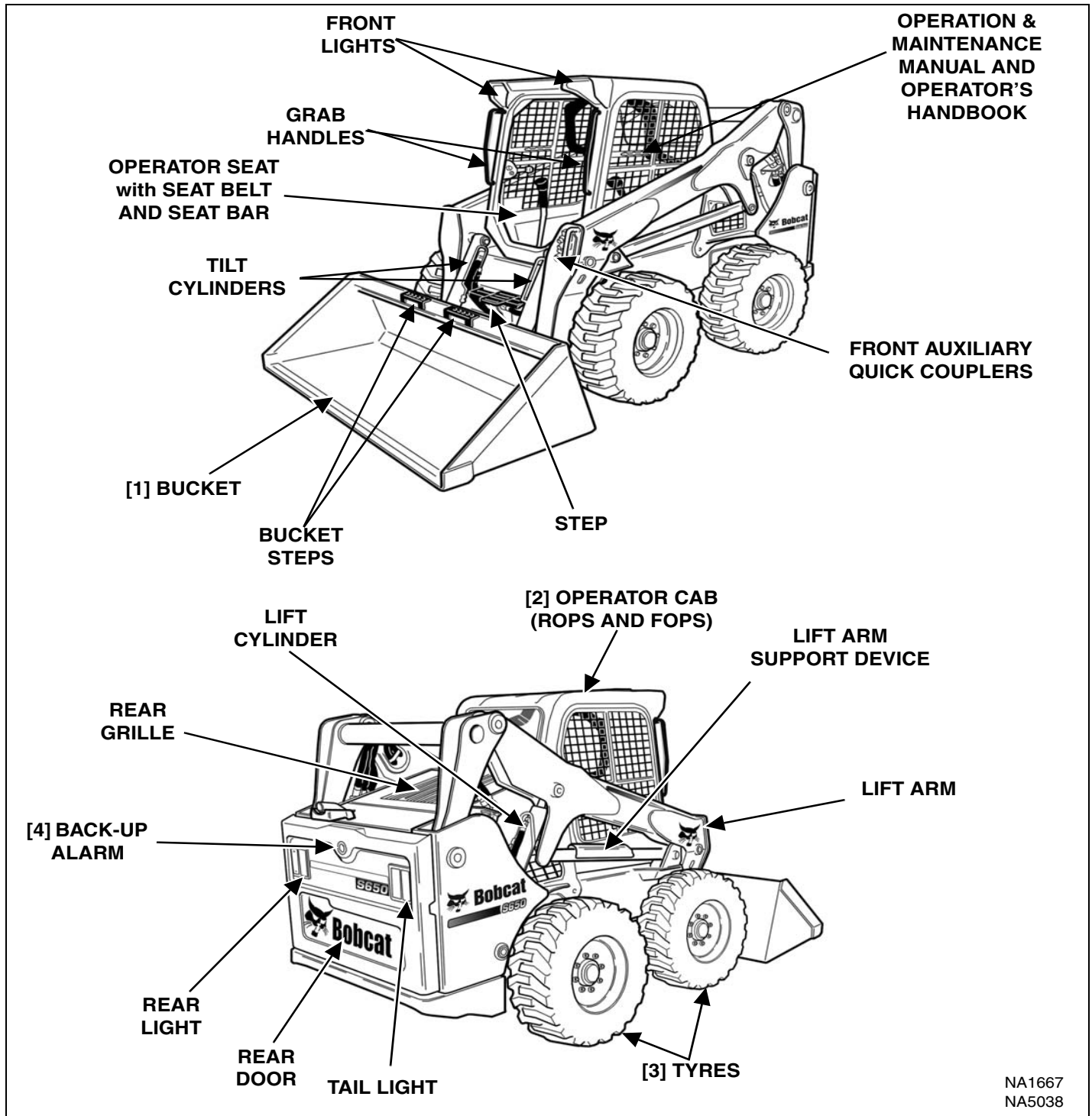

NA1667
NA5038

- [1] BUCKETS - Several different buckets and other attachments are available for the Bobcat loader.
- [2] ROPS, FOPS - Roll Over Protective Structure, per ISO 3471, and Falling Object Protective Structure per ISO 3449, Level I. Level II is available.
- [3] TYRES - Standard tyres are shown. Several different tyre styles and sizes are available for the Bobcat loader.
- [4] Optional or Field Accessory. (Not Standard Equipment.)



FEATURES, ACCESSORIES AND ATTACHMENTS

Standard Items

Model S650 Bobcat loaders are equipped with the following standard items:

- Adjustable Suspension Seat
- Automatically Activated Glow Plugs
- Auxiliary Hydraulics
- Bobcat Interlock Control System (BICS™)
- Bob-Tach™
- Cab (includes: rear and side windows and polycarbonate top window) ROPS and FOPS Approved
- Cab Accessory Harness
- CE Certification
- Deluxe Interior with Storage Compartments
- Engine / Hydraulic Systems Shutdown
- Front Horn
- Instrumentation: Hourmeter, RPM, System Voltage; Engine Temperature and Fuel Gauges; Warning Lights
- Lift Arm Support Device
- Lights, Front and Rear
- Parking Brake
- Seat Bar
- Seat Belt
- Sound Reduction Kit (Reduces noise at operator ear)
- Spark Arrester Muffler
- Tailgate Lock
- Turbo-Charger
- Tyres (Bobcat Heavy Duty, 12-16.5, 12 PR)

Options And Accessories

Below is a list of some equipment available from your Bobcat loader dealer as Dealer and / or Factory Installed Accessories and Factory Installed Options. See your Bobcat dealer for other available options and accessories.

- Adjustable Air Ride Suspension Seat
- Air Conditioning
- Air Filter Precleaner
- Attachment Control Device (ACD) (7-Pin, 14-Pin)
- Auxiliary Hydraulic Coupler Guard
- Back-up Alarm
- Bucket Shields
- Cab Door with Emergency Exit
- Cab Heater
- Cab Reseal Plug Kit
- Controls:
 - Advanced Control System (ACS)
(Selectable Foot Pedal or Hand Control)
 - Advanced Hand Controls (AHC)
 - Selectable Joystick Controls (SJC)
(Selectable 'ISO' or 'H' Pattern Control)
 - Standard Controls
- Counterweight Kit
- Deluxe Instrumentation Panel

Options And Accessories (Cont'd)

- Dual Steering Damper
- Engine Compartment Seal Kit
- Engine Heater
- Exhaust Purifying Muffler
- Extended Pedals
- Fire Extinguisher
- Foot Area Duct Kit
- FOPS Kit (Level II)
- FOPS Window Kit
- Four-Way Flashers (Also adds Turn Signal function)
- Front and Rear Light Guards
- High-Flow Auxiliary Hydraulics
- Hydraulic Bucket Positioning (Includes On / Off Selection)
- Isolated Rear Pump Support
- Keyless Start
- Lift Kit (Four-Point, Single-Point)
- Lights Extension Kit for Wide Attachments
- Locking Fuel Cap
- Maintenance Platform
- Muffler Guard
- Power Bob-Tach
- Radio
- Rear Auxiliary Hydraulics
- Rear Bumper Kit
- Rear Window Wiper
- Road Kit
- Rotating Beacon
- Seat Belt with 3-Point Restraint (Std. on Two-Speed Models)
- Seat Belt - 3 in. Wide
- Seat Belt - Retractable
- Special Applications Kit
- Strobe Light
- Two-Speed Travel
- Tyres:
 - Bobcat Heavy Duty Offset, 12 - 16.5, 12 PR
 - Bobcat Heavy Duty Poly Fill, 12 - 16.5, 12 PR
 - Bobcat Severe Duty, 12 - 16.5, 12 PR
 - Bobcat Severe Duty Poly Fill, 12 - 16.5, 12 PR
 - Bobcat Solidflex, 33 x 6 x 11
 - Bobcat Super Float Offset, 33 x 15.5 - 16.5, 12 PR
- Windows:
 - Polycarbonate Rear Window
 - Polycarbonate Side Windows

Specifications subject to change without notice and standard items may vary.



**FEATURES, ACCESSORIES AND ATTACHMENTS
(CONT'D)**

These and other attachments are approved for use on this model loader. Do not use unapproved attachments. Attachments not manufactured by Bobcat may not be approved.

The versatile Bobcat loader quickly turns into a multi-job machine with a tight-fit attachment hook-up ... from bucket to grapple to pallet fork to backhoe and a variety of other attachments.

See your Bobcat dealer for information about approved attachments and attachment Operation & Maintenance Manuals.

Increase the versatility of your Bobcat loader with a variety of bucket styles and sizes.

Buckets Available

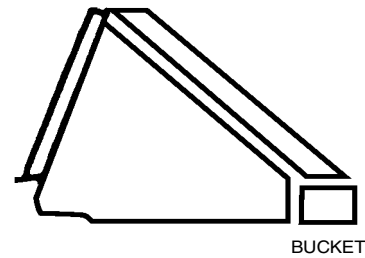

Many bucket styles, widths and different capacities are available for a variety of different applications. They include Construction & Industrial, Low Profile, Fertilizer and Snow, to name a few. See your Bobcat dealer for the correct bucket for your Bobcat loader and application.

Attachments

- Angle Broom
- Auger
- Backhoe
- Blades
 - Box Blade
 - Dozer Blade
 - Snow Blade
 - Snow V-Blade
- Breaker, Hydraulic
- Buckets
- Bucket Adapter
- Combination Bucket
- Concrete Pump
- Digger
- Drop Hammer
- Dumping Hopper
- Flail Cutter
- Forks, Utility
- Grader
- Grapple; Industrial, Root, Utility
- Landplane
- Landscape Rake
- Mower
- Packer Wheel
- Pallet Fork
- Planer
- Rear Stabilisers
- Rotary Cutter (Brushcat)
- Rotary Grinder
- Scarifier
- Scraper
- Snow Pusher
- Snowblower
- Soil Conditioner
- Spreader
- Steel Tracks
- Stump Grinder
- Sweeper
- Three-Point Hitch Adapter
- Tiller
- Tilt-Tatch™

- Tree Transplanter
- Trencher
- Utility Frame
- Vibratory Roller
- Water Kit
- Whisker Broom
- X-Change™ Frame

High-Flow Attachments

The following attachments are approved for use on High-Flow machines. See your Bobcat dealer for an updated list of approved attachments.

- Auger
- Concrete Pump
- Flail Cutter
- Planer
- Rotary Cutter (Brushcat)
- Rotary Grinder
- Snowblower
- Soil Conditioner
- Stump Grinder
- Tiller
- Trencher
- Wheel Saw
- Wood Chipper

**FEATURES, ACCESSORIES AND ATTACHMENTS
(CONT'D)**

Special Applications Kit



AVOID INJURY OR DEATH

Some attachment applications can cause flying debris or objects to enter front, top or rear cab openings. Install the Special Applications Kit to provide added operator protection in these applications.

W-2737-0508

Figure 5

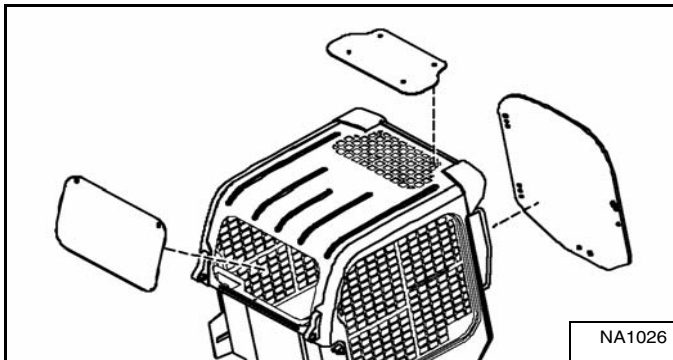

Available for special applications to restrict material from entering cab openings. Kit includes 12,7 mm (0.5 in) thick polycarbonate front door and polycarbonate rear window [Figure 5].

Polycarbonate top window (standard item) must be installed for special applications to restrict material from entering cab openings.

See your Bobcat dealer for availability.

Special Applications Kit Inspection And Maintenance

- Inspect for cracks or damage. Replace if required.
- Pre-rinse with water to remove gritty materials.
- Wash with a mild household detergent and warm water.
- Use a sponge or soft cloth. Rinse well with water and dry with a clean soft cloth or rubber squeegee.
- Do not use abrasive or highly alkaline cleaners.
- Do not clean with metal blades or scrapers.



Bobcat®



SAFETY & TRAINING RESOURCES

SAFETY INSTRUCTIONS	19
Before Operation	19
Safe Operation Is The Operator's Responsibility	20
Safe Operation Needs A Qualified Operator	20
Avoid Silica Dust	21
FIRE PREVENTION	21
Maintenance	21
Operation	21
Electrical	21
Hydraulic System	22
Fueling	22
Starting	22
Spark Arrester Exhaust System	22
Welding And Grinding	22
Fire Extinguishers	22
PUBLICATIONS AND TRAINING RESOURCES	23
MACHINE SIGNS (DECALS)	24
No-Text Safety Signs	27



Bobcat®



SAFETY INSTRUCTIONS

Before Operation

Carefully follow the operating and maintenance instructions in this manual.

The Bobcat loader is highly maneuverable and compact. It is rugged and useful under a wide variety of conditions. This presents an operator with hazards associated with off motorway, rough terrain applications, common with Bobcat loader usage.

The Bobcat loader has an internal combustion engine with resultant heat and exhaust. All exhaust gases can kill or cause illness so use the Loader with adequate ventilation.

The dealer explains the capabilities and restrictions of the Bobcat loader and attachment for each application. The dealer demonstrates the safe operation according to Bobcat instructional materials, which are also available to operators. The dealer can also identify unsafe modifications or use of unapproved attachments. The attachments and buckets are designed for a Rated Operating Capacity (some have restricted lift heights). They are designed for secure fastening to the Bobcat loader. The user must check with the dealer, or Bobcat literature, to determine safe loads of materials of specified densities for the machine - attachment combination.

The following publications and training materials provide information on the safe use and maintenance of the Bobcat machine and attachments:

- The Delivery Report is used to assure that complete instructions have been given to the new owner and that the machine and attachment is in safe operating condition.
- The Operation & Maintenance Manual delivered with the machine or attachment gives operating information as well as routine maintenance and service procedures. It is a part of the machine and can be stored in a container provided on the machine. Replacement Operation & Maintenance Manuals can be ordered from your Bobcat dealer.
- Machine signs (decals) instruct on the safe operation and care of your Bobcat machine or attachment. The signs and their locations are shown in the Operation & Maintenance Manual. Replacement signs are available from your Bobcat dealer.
- An Operator's Handbook is fastened to the operator cab of the loader. Its brief instructions are convenient to the operator. See your Bobcat dealer for more information on translated versions.

The dealer and owner / operator review the recommended uses of the product when delivered. If the owner / operator will be using the machine for a different application(s) he or she must ask the dealer for recommendations on the new use.



SAFETY INSTRUCTIONS (CONT'D)

Safe Operation Is The Operator's Responsibility



Safety Alert Symbol

This symbol with a warning statement means:
"Warning, be alert! Your safety is involved!"
Carefully read the message that follows.



WARNING

Operator must have instructions before operating the machine. Untrained operators can cause injury or death.

W-2001-0502

IMPORTANT

This notice identifies procedures which must be followed to avoid damage to the machine.

I-2019-0284



DANGER

The signal word DANGER on the machine and in the manuals indicates a hazardous situation which, if not avoided, will result in death or serious injury.

D-1002-1107



WARNING

The signal word WARNING on the machine and in the manuals indicates a potentially hazardous situation which, if not avoided, could result in death or serious injury.

W-2044-1107

The Bobcat loader and attachment must be in good operating condition before use.

Check all of the items on the Bobcat Service Schedule Decal under the 8-10 hour column or as shown in the Operation & Maintenance Manual.

Safe Operation Needs A Qualified Operator

For an operator to be qualified, he or she must not use drugs or alcoholic drinks which impair alertness or coordination while working. An operator who is taking prescription drugs must get medical advice to determine if he or she can safely operate a machine.

A Qualified Operator Must Do The Following:

Understand the Written Instructions, Rules and Regulations

- The written instructions from Bobcat Company include the Delivery Report, Operation & Maintenance Manual, Operator's Handbook and machine signs (decals).
- Check the rules and regulations at your location. The rules may include an employer's work safety requirements. For driving on public roads, the machine must be equipped as stipulated by the local regulations authorising operation on public roads in your specific country. Regulations may identify a hazard such as a utility line.

Have Training with Actual Operation

- Operator training must consist of a demonstration and verbal instruction. This training is given by your Bobcat dealer before the product is delivered.
- The new operator must start in an area without bystanders and use all the controls until he or she can operate the machine and attachment safely under all conditions of the work area. Always fasten seat belt before operating.

Know the Work Conditions

- Know the weight of the materials being handled. Avoid exceeding the Rated Operating Capacity (ROC) of the machine. Material which is very dense will be heavier than the same volume of less dense material. Reduce the size of the load if handling dense material.
- The operator must know any prohibited uses or work areas, for example, he or she needs to know about excessive slopes.
- Know the location of any underground lines.
- Wear tight fitting clothing. Always wear safety glasses when doing maintenance or service. Safety glasses, respiratory equipment, hearing protection or Special Applications Kits are required for some work. See your Bobcat dealer about Bobcat Safety Equipment for your model.

SAFETY INSTRUCTIONS (CONT'D)

Avoid Silica Dust



Cutting or drilling concrete containing sand or rock containing quartz may result in exposure to silica dust. Use a respirator, water spray or other means to control dust.

FIRE PREVENTION



Maintenance

The machine and some attachments have components that are at high temperatures under normal operating conditions. The primary source of high temperatures is the engine and exhaust system. The electrical system, if damaged or incorrectly maintained, can be a source of arcs or sparks.

Flammable debris (leaves, straw, etc.) must be removed regularly. If flammable debris is allowed to accumulate, it can cause a fire hazard. Clean often to avoid this accumulation. Flammable debris in the engine compartment is a potential fire hazard.

The operator's area, engine compartment and engine cooling system must be inspected every day and cleaned if necessary to prevent fire hazards and overheating.

All fuels, most lubricants and some coolants mixtures are flammable. Flammable fluids that are leaking or spilled onto hot surfaces or onto electrical components can cause a fire.

Operation

Do not use the machine where exhaust, arcs, sparks or hot components can contact flammable material, explosive dust or gases.

Electrical



Check all electrical wiring and connections for damage. Keep the battery terminals clean and tight. Repair or replace any damaged part or wires that are loose or frayed.

Battery gas can explode and cause serious injury. Use the procedure in the Operation & Maintenance Manual for connecting the battery and for jump starting. Do not jump start or charge a frozen or damaged battery. Keep any open flames or sparks away from batteries. Do not smoke in battery charging area.



FIRE PREVENTION (CONT'D)

Hydraulic System

Check hydraulic tubes, hoses and fittings for damage and leakage. Never use open flame or bare skin to check for leaks. Hydraulic tubes and hoses must be properly routed and have adequate support and secure clamps. Tighten or replace any parts that show leakage.

Always clean fluid spills. Do not use petrol or diesel fuel for cleaning parts. Use commercial non-flammable solvents.

Fueling



Stop the engine and let it cool before adding fuel. No smoking! Do not refuel a machine near open flames or sparks. Fill the fuel tank outdoors.

Starting

Do not use ether or starting fluids on any engine that has glow plugs or air intake heater. These starting aids can cause explosion and injure you or bystanders.

Use the procedure in the Operation & Maintenance Manual for connecting the battery and for jump starting.

Spark Arrester Exhaust System

The spark arrester exhaust system is designed to control the emission of hot particles from the engine and exhaust system, but the muffler and the exhaust gases are still hot.

Check the spark arrester exhaust system regularly to make sure it is maintained and working properly. Use the procedure in the Operation & Maintenance Manual for cleaning the spark arrester muffler (if equipped).

Welding And Grinding

Always clean the machine and attachment, disconnect the battery, and disconnect the wiring from the Bobcat controllers before welding. Cover rubber hoses, battery and all other flammable parts. Keep a fire extinguisher near the machine when welding.

Have good ventilation when grinding or welding painted parts. Wear dust mask when grinding painted parts. Toxic dust or gas can be produced.

Dust generated from repairing non-metallic parts such as hoods, fenders or covers can be flammable or explosive. Repair such components in a well ventilated area away from open flames or sparks.

Fire Extinguishers

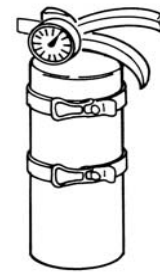

Know where fire extinguishers and first aid kits are located and how to use them. Inspect the fire extinguisher and service the fire extinguisher regularly. Obey the recommendations on the instructions plate.

PUBLICATIONS AND TRAINING RESOURCES

The following publications are also available for your Bobcat loader. You can order them from your Bobcat dealer.

For the latest information on Bobcat products and the Bobcat Company, visit our web site at www.training.bobcat.com or www.bobcat.com.

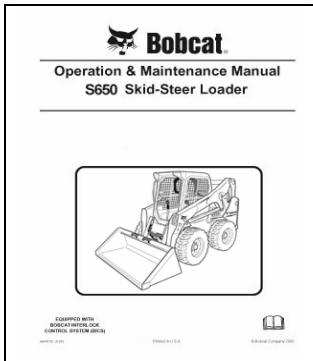

OPERATION & MAINTENANCE MANUAL

6987167

Complete instructions on the correct operation and the routine maintenance of the Bobcat loader.



S650 SERVICE MANUAL

6987168

Complete maintenance instructions for your Bobcat loader.



OPERATOR'S HANDBOOK

6987174

Gives basic operation instructions and safety warnings.



MACHINE SIGNS (DECALS) (CONT'D)

Follow the instructions on all the Machine Signs (Decals) that are on the loader. Replace any damaged machine signs and be sure they are in the correct locations. Machine signs are available from your Bobcat loader dealer.

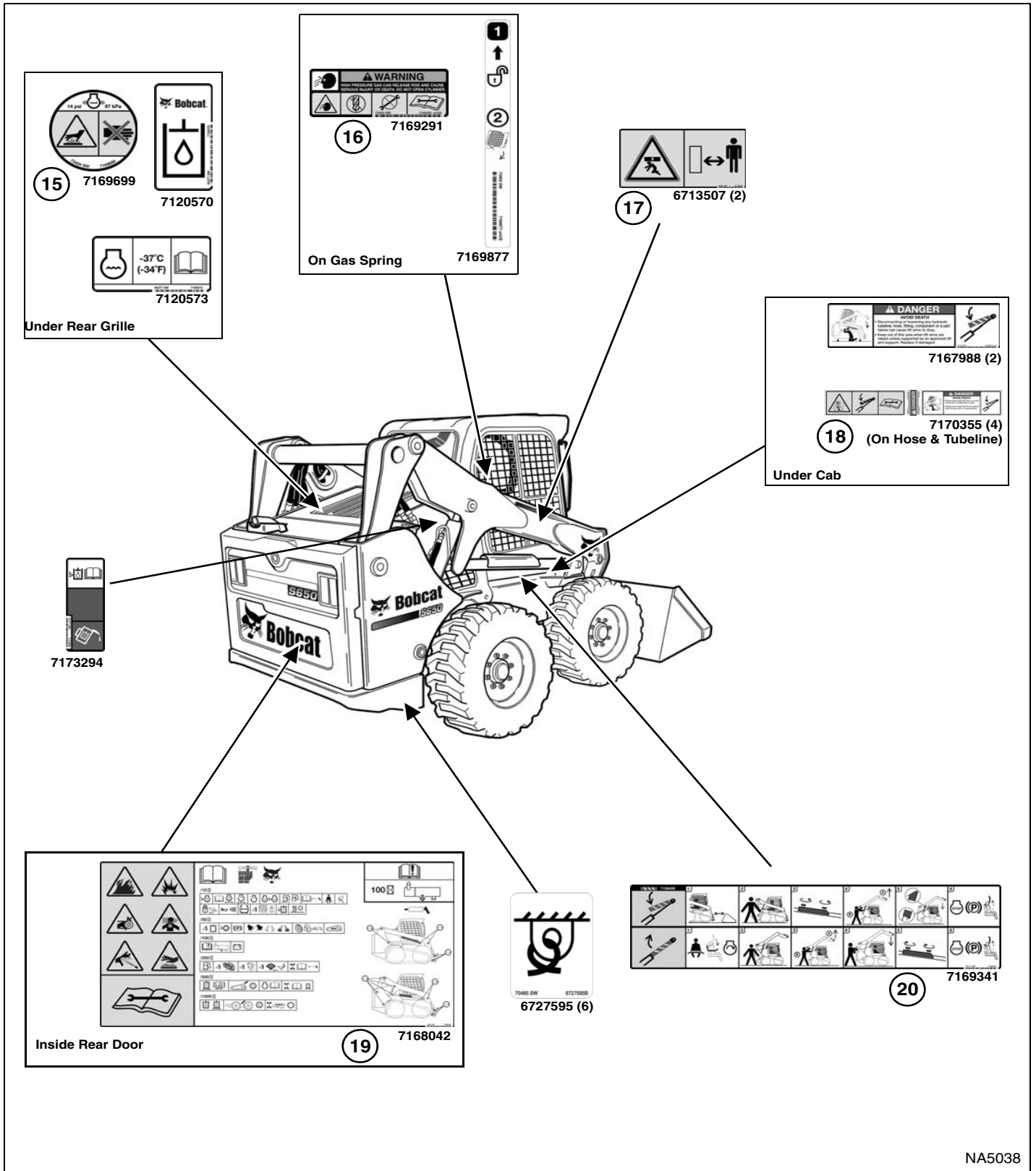



Bobcat®

MACHINE SIGNS (DECALS) (CONT'D)

No-Text Safety Signs

Safety signs are used to alert the equipment operator or maintenance person to hazards that may be encountered in the use and maintenance of the equipment. The location and description of the safety signs are detailed in this section. Please become familiarized with all safety signs installed on the machine / attachment.

Vertical Configuration

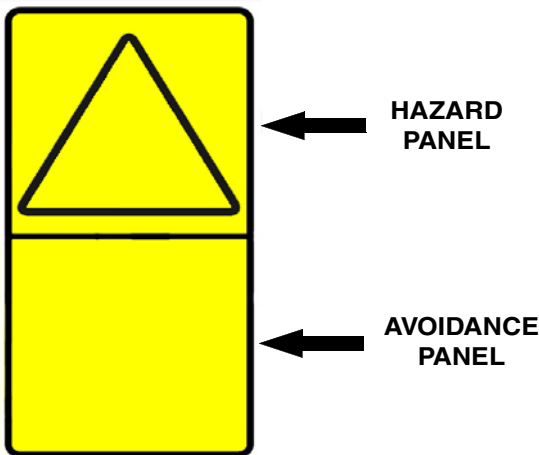

Horizontal Configuration

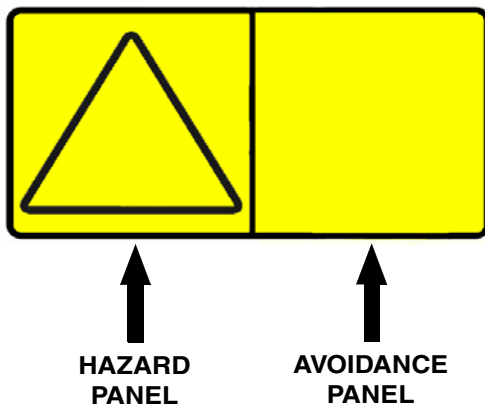

The format consists of the hazard panel(s) and the avoidance panel(s):

Hazard panels depict a potential hazard enclosed in a safety alert triangle.

Avoidance panels depict actions required to avoid the hazards.

A safety sign may contain more than one hazard panel and more than one avoidance panel.

NOTE: See the numbered MACHINE SIGNS (DECALS) on Page 24 and MACHINE SIGNS (DECALS) (CONT'D) on Page 25 for the machine location of each correspondingly numbered no-text decal.

1. General Hazard Warning (7168038)

This safety sign is located in the operator cab in the lower right hand corner.



AVOID INJURY OR DEATH

Never use the loader without instructions. Read Operation & Maintenance Manual and Handbook.

Never modify equipment or use attachments not approved by Bobcat Company.

On slopes, keep heavy end of loader uphill.

Do not travel or turn with lift arms up. Load, unload and turn on flat level ground. Do not exceed Rated Operating Capacity (see sign on loader).

W-2837-0310

MACHINE SIGNS (DECALS) (CONT'D)

No-Text Safety Signs (Cont'd)

2. To Leave the Loader (7168141)

This safety sign is located in the operator cab in the lower right hand corner.



AVOID INJURY OR DEATH

TO LEAVE THE LOADER:

1. Lower the lift arms and put attachment flat on the ground.
2. Stop the engine.
3. Engage the brake.
4. Raise seat bar.
5. Move pedals and hand controls until both lock.
6. Exit the loader.

W-2838-0310

3. SJC Control Pattern Switch (7177707)

This safety sign is located in the operator cab around the SJC control pattern switch on the right panel.

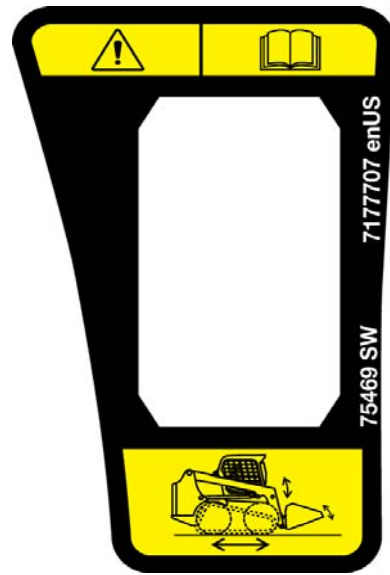

**ACCIDENTAL LOADER MOVEMENT CAN CAUSE
SERIOUS INJURY OR DEATH**

Read and understand the Operation & Maintenance Manual for more information.

- Drive, lift arm and tilt functions operate on different joysticks in each control mode.
- Know and understand the selected control mode before operating.

W-2788-0309

MACHINE SIGNS (DECALS) (CONT'D)

No-Text Safety Signs (Cont'd)

4. SJC Left Hand Joystick (7168082)

This safety sign is located in the operator cab on the left armrest.

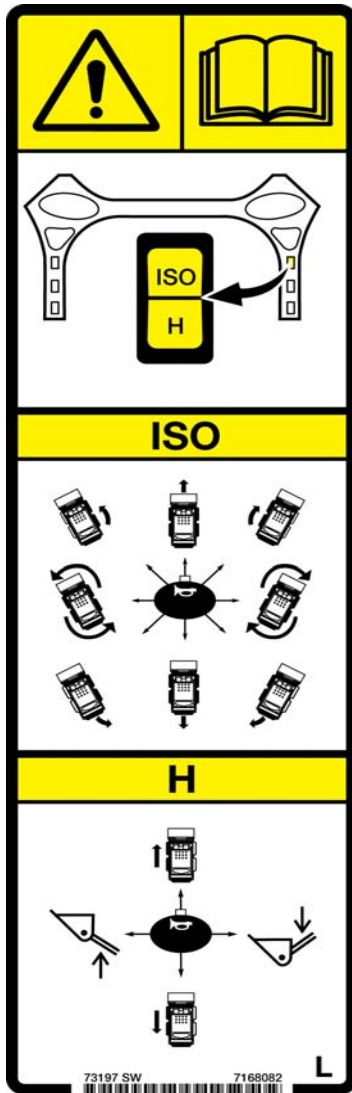

5. To Leave the Loader (7168143)

This safety sign is located in the operator cab in the lower right hand corner.

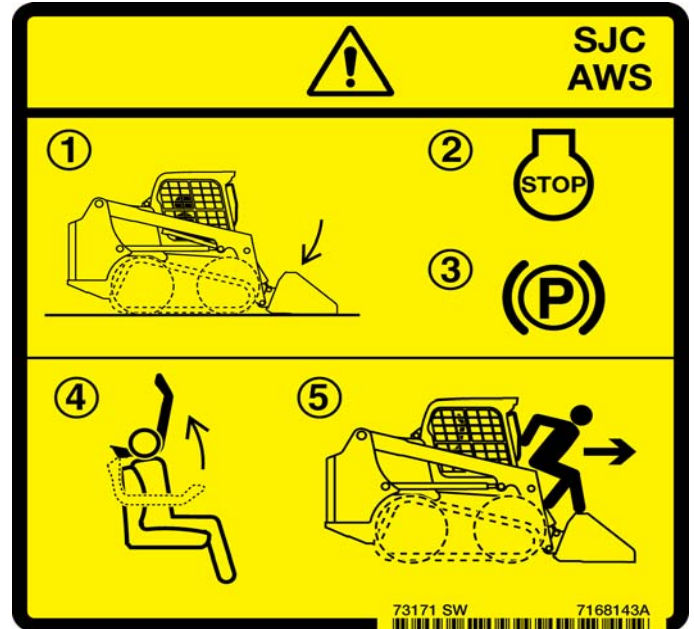

AVOID INJURY OR DEATH

TO LEAVE THE LOADER:

1. Lower the lift arms and put attachment flat on the ground.
2. Stop the engine.
3. Engage the brake.
4. Raise seat bar.
5. Exit the loader.

W-2839-0310



ACCIDENTAL LOADER MOVEMENT CAN CAUSE SERIOUS INJURY OR DEATH

Read and understand the Operation & Maintenance Manual for more information.

- Drive, lift arm and tilt functions operate on different joysticks in each control mode.
- Know and understand the selected control mode before operating.

W-2788-0309

MACHINE SIGNS (DECALS) (CONT'D)

No-Text Safety Signs (Cont'd)

6. Unexpected Loader, Lift Arm or Attachment Movement (7168139)

This safety sign is located in the operator cab on the left side of the seat.

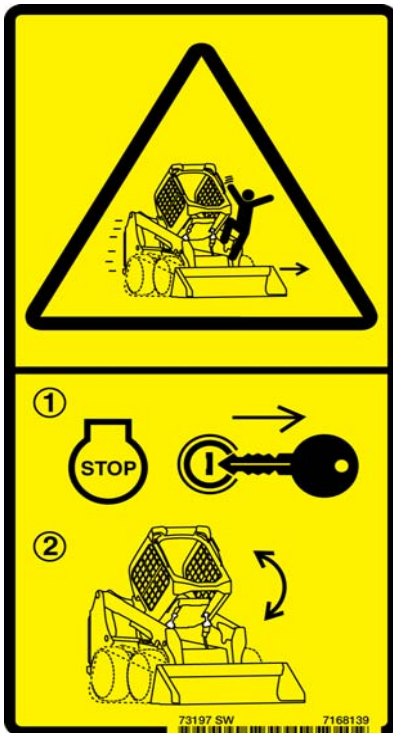

UNEXPECTED LOADER, LIFT ARM OR ATTACHMENT MOVEMENT CAUSED BY CAB CONTACT WITH CONTROLS CAN CAUSE SERIOUS INJURY OR DEATH

- **STOP ENGINE** before raising or lowering cab.

W-2758-0908

7. High Range Speeds (7184346)

This safety sign is located in the operator cab on loaders equipped with a seat belt with three-point restraint.



HITTING OBSTRUCTIONS AT HIGH RANGE SPEEDS CAN CAUSE SERIOUS INJURY OR DEATH
Fasten shoulder belt for additional restraint when operating at high range speeds.

W-2754-0908

8. Back-Up Alarm (7180087)

This safety sign is located in the operator cab on the lower left side.



AVOID INJURY OR DEATH

- Always keep bystanders away from the work area and travel path.
- The operator must always look in the direction of travel.
- The back-up alarm must sound when operating the machine in the reverse direction.

W-2783-0409

MACHINE SIGNS (DECALS) (CONT'D)

No-Text Safety Signs (Cont'd)

9. Tipping, Rollover or Loss of Visibility (7168037)

This safety sign is located on the back side of the lift arms facing the operator.



TIPPING, ROLLOVER OR LOSS OF VISIBILITY CAN CAUSE SERIOUS INJURY OR DEATH
Carry load low.

AVOID INJURY OR DEATH

- Never carry riders.
- Never use loader as a man lift or work platform.

W-2836-0310

W-2835-0310

10. Frame Raising (7168034)

This safety sign is located on the front of the loader.



12. Lift Arm Crushing (7168033)

This safety sign is located on the front of the loader.

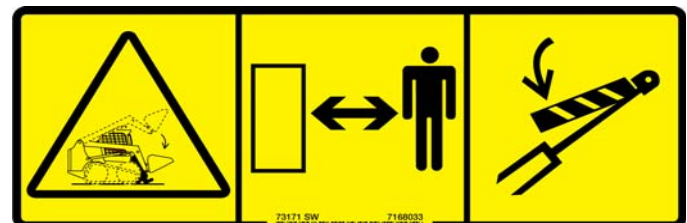

AVOID DEATH
Attachment can be forced against the ground and cause front frame to raise.

AVOID DEATH
Keep out of this area when lift arms are raised unless supported by an approved lift arm support device.

Never go under or reach under lift arms or lift cylinder without an approved lift arm support device installed.

Moving lift arm control or failure of a part can cause lift arms to drop.

D-1021-0310

D-1020-0310

11. Falling Hazard (7168040)

This safety sign is located on the front of the loader.

MACHINE SIGNS (DECALS) (CONT'D)

No-Text Safety Signs (Cont'd)

13. Single-Point Lift (7142142)

This safety sign is located on the side arm of the single-point lift.



**FAILURE OF THE LIFT ASSEMBLY CAN CAUSE
SERIOUS INJURY OR DEATH**

BEFORE LIFTING LOADER:

1. Check the hardware and fasteners of the Single Point Lift and Operator Cab (ROPS) for proper torque.
 2. Inspect Single Point Lift for damage or cracked welds. Repair or replace components as necessary.
- No riders on loader during lifting. Keep 5 m (15 ft) away while lifting.
 - See Operation & Maintenance Manual for more information.

W-2841-0910

14. Four-Point Lift (7168020)

This safety sign is located on the front of the loader.



**FAILURE OF THE LIFT ASSEMBLY CAN CAUSE
SERIOUS INJURY OR DEATH**

BEFORE LIFTING LOADER:

1. Check the hardware and fasteners at all lift points for proper torque.
 2. Inspect lift points for damage or cracked welds. Repair or replace components as necessary.
- No riders on loader and keep 5 m (15 ft) away while lifting.
 - See Operation & Maintenance Manual for more information.

W-2840-0910

MACHINE SIGNS (DECALS) (CONT'D)

No-Text Safety Signs (Cont'd)

15. Hot Pressurised Fluid (7169699)

This safety sign is located on the engine coolant tank cap.



**HOT PRESSURISED FLUID CAN CAUSE
SERIOUS BURNS**

- Never open hot.
- OPEN SLOWLY.

W-2755-EN-0909

16. High Pressure Gas (7169291)

This safety sign is located on the gas spring component(s) supporting the cab and also on the front door option.



**HIGH PRESSURE GAS CAN RELEASE ROD AND
CAUSE SERIOUS INJURY OR DEATH**

- Do not open cylinder.
- See Service Manual for more information.

W-2756-0908

17. Crush Hazard (6713507)

This safety sign is located on the side of each lift arm.



**Keep away from the operating machine to avoid
serious injury or death.**

W-2520-0106

18. Lift Arm Crushing (7170355)

This safety sign is located on certain hoses or tubelines inside the loader frame underneath the operator cab.



AVOID DEATH

- Disconnecting hydraulic lines can cause the lift arms or attachment to drop.
- Always use an approved lift arm support when lift arms are in a raised position.

D-1008-0409

MACHINE SIGNS (DECALS) (CONT'D)

No-Text Safety Signs (Cont'd)

19. Service Checklist And Schedule (7168042)

This safety sign is located inside the rear door (tailgate).

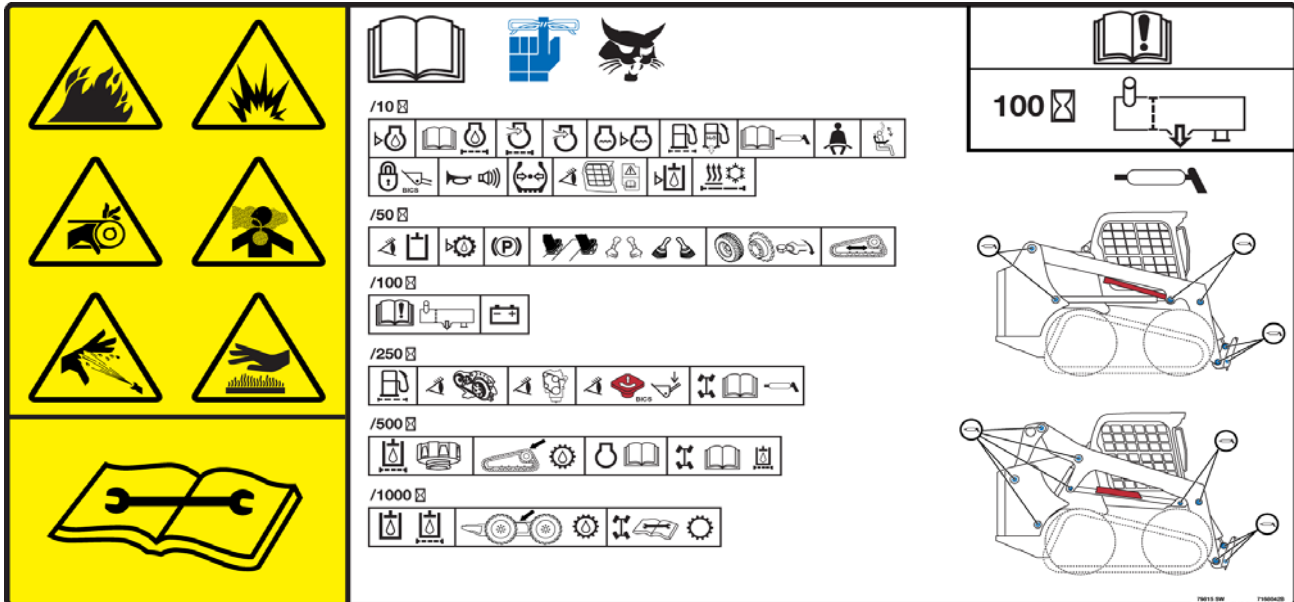

! WARNING

AVOID INJURY OR DEATH

- Keep door / cover closed except for service.
- Keep engine clean of flammable material.
- Keep body, loose objects and clothing away from electrical contacts, moving parts, hot parts and exhaust.
- Do not use the machine in space with explosive dusts or gases or with flammable material near exhaust.
- Never use ether or starting fluid on diesel engine with glow plugs or air intake heater. Use only starting aids as approved by engine manufacturer.
- Leaking fluids under pressure can enter skin and cause serious injury.
- Battery acid causes severe burns; wear goggles. If acid contacts eyes, skin, or clothing, flush with water. For contact with eyes, flush and get medical attention.
- Battery makes flammable and explosive gas. Keep arcs, sparks, flames and lighted tobacco away.
- For jump start, connect negative cable to the machine engine last (never at the battery). After jump start, remove negative connection at the engine first.
- Exhaust gases can kill. Always ventilate.

W-2782-0409

IMPORTANT

This machine is factory equipped with a spark arrester exhaust system.

The spark arrester muffler, if equipped, must be cleaned to keep it in working condition. The spark arrester muffler must be serviced by dumping the spark chamber every 100 hours of operation.

On some models, the turbocharger functions as the spark arrester and must operate correctly for proper spark arrester function.

If this machine is operated on flammable forest, brush, or grass covered land, a spark arrester attached to the exhaust system may be required and must be maintained in working order. Refer to local laws and regulations for spark arrester requirements.

I-2284-EN-0909

MACHINE SIGNS (DECALS) (CONT'D)

No-Text Safety Signs (Cont'd)

20. Lift Arm Support Device (7169341)

This safety sign is located on the outside of the operator cab on the lower right side.

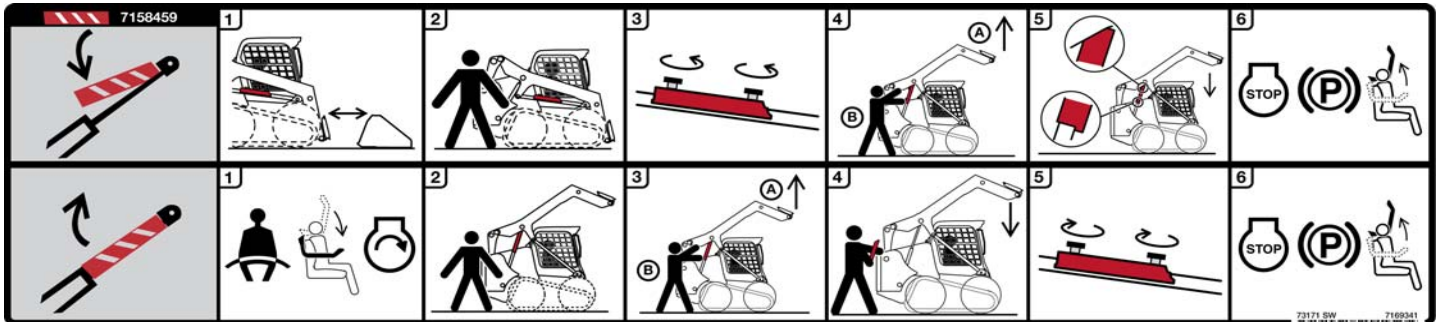

To Install Approved Lift Arm Support:

1. Remove attachment from loader.
2. Stay in seat while second person removes lift arm support from storage position.
3. Remove clamping knobs and lift arm support.
4. Raise lift arms while second person positions lift arm support against cylinder rod.
5. Lower lift arms slowly until lift arm support is held securely between lift arm and cylinder.
6. Stop the engine, engage the parking brake and raise the seat bar.

To Remove Lift Arm Support:

1. Fasten seat belt and lower seat bar before starting the engine.
2. Stay in seat while second person removes lift arm support from cylinder rod.
3. Raise lift arms while second person removes lift arm support from cylinder rod.
4. Stay in seat until the lift arms are lowered all the way.
5. Return lift arm support to storage position and secure with clamping knobs.
6. Stop the engine, engage the parking brake and raise the seat bar.

NOTE: More illustrated and detailed information regarding Installing and Removing the lift arm support device is located in this manual. (See LIFT ARM SUPPORT DEVICE on Page 135.)



Bobcat®



OPERATING INSTRUCTIONS

INSTRUMENT PANEL IDENTIFICATION	41
Overview	41
Left Panel	42
Display Screen	45
Right Panel (Standard Key Panel)	46
Right Panel (Keyless Start Panel)	47
Right Panel (Deluxe Instrumentation Panel)	48
Left Switch Panel	50
Right Switch Panel	50
Left Side Lower Panel	51
Right Side Lower Panel	51
Radio	52
CONTROL IDENTIFICATION	54
Standard Controls	54
Advanced Control System (ACS)	55
Advanced Hand Controls (AHC)	56
Selectable Joystick Controls (SJC)	57
OPERATOR CAB	58
Description	58
Cab Light	58
Door Operation	58
Front Wiper	59
Side Windows	59
SEAT BAR RESTRAINT SYSTEM	60
Operation	60
BOBCAT INTERLOCK CONTROL SYSTEM (BICS™)	61
Operation	61
LIFT ARM BYPASS CONTROL	62
Operation	62
PARKING BRAKE	62
Operation	62
TRACTION LOCK OVERRIDE	63
Operation	63
ENGINE SPEED CONTROL	63
Operation	63
EMERGENCY EXIT	64
External Access	64
Rear Window	64
Front Door	64



BACK-UP ALARM SYSTEM	.66
Description	.66
Operation	.66
DRIVING AND STEERING THE LOADER	.67
Available Control Configurations	.67
Operation (Standard, ACS And AHC)	.67
Operation (SJC) In 'ISO' Control Pattern	.68
Operation (SJC) In 'H' Control Pattern	.69
STOPPING THE LOADER	.69
Using The Control Levers Or Joysticks	.69
TWO-SPEED CONTROL	.70
Description	.70
Operation (Standard, ACS And AHC) (If Equipped)	.70
Operation (SJC) (If Equipped)	.70
SPEED MANAGEMENT	.71
Operation	.71
Changing The Factory Default Setting	.72
DRIVE RESPONSE	.73
Description	.73
Operation	.73
STEERING DRIFT COMPENSATION	.75
Description	.75
Operation	.75
HYDRAULIC CONTROLS	.77
Description	.77
Standard Controls (Also ACS In FOOT Pedal Mode)	.77
Advanced Control System (ACS) In HAND Control Mode And Advanced Hand Controls (AHC)	.78
Selectable Joystick Controls (SJC) In 'ISO' Control Pattern	.78
Selectable Joystick Controls (SJC) In 'H' Control Pattern	.79
Hydraulic Bucket Positioning	.79
FRONT Auxiliary Hydraulics Operation	.80
FRONT Auxiliary Hydraulics Operation (CONTINUOUS FLOW)	.81
FRONT Auxiliary Hydraulics Operation (REVERSE CONTINUOUS FLOW)	.81
REAR Auxiliary Hydraulics Operation	.82
High-Flow Hydraulics Operation	.83
Quick Couplers	.83
Relieve Auxiliary Hydraulic Pressure (Loader And Attachment)	.84
ATTACHMENT CONTROL DEVICE (ACD)	.85
Description	.85
DAILY INSPECTION	.86
Daily Inspection And Maintenance	.86



PRE-STARTING PROCEDURE	88
Entering The Loader	88
Operation & Maintenance Manual And Operator's Handbook Locations	88
Seat Adjustment	89
Joystick Position Adjustment	90
Seat Belt Adjustment	91
Seat Bar	91
STARTING THE ENGINE	92
Standard Key Panel	92
Keyless Start Panel	94
Deluxe Instrumentation Panel	96
Cold Temperature Starting	98
Warming The Hydraulic / Hydrostatic System	98
MONITORING THE DISPLAY PANELS	99
Left Panel	99
Warning And Shutdown	99
STOPPING THE ENGINE AND LEAVING THE LOADER	100
Procedure	100
COUNTERWEIGHTS	101
Description	101
Effect On The Loader And Loader Operation	101
When To Consider Using Counterweights	101
When To Consider Removing Counterweights	101
Accessories That Affect Machine Weight	101
ATTACHMENTS	102
Choosing The Correct Bucket	102
Pallet Fork	102
Installing And Removing The Attachment (Hand Lever Bob-Tach)	103
Installing And Removing The Attachment (Power Bob-Tach)	105
OPERATING PROCEDURE	110
Inspect The Work Area	110
Basic Operating Instructions	110
Driving On Public Roads	110
Operating With A Full Bucket	111
Operating With An Empty Bucket	111
Filling And Emptying The Bucket (Foot Pedals)	112
Leveling The Ground Using Float (Foot Pedals)	113
Digging And Filling A Hole (Foot Pedals)	114
Filling And Emptying The Bucket (ACS - Handles, AHC - Handles And SJC - 'H' Pattern)	115
Leveling The Ground Using Float (ACS - Handles, AHC - Handles And SJC - 'H' Pattern)	116
Digging And Filling A Hole (ACS - Handles, AHC - Handles And SJC - 'H' Pattern)	117
Filling And Emptying The Bucket (SJC - 'ISO' Pattern)	118
Leveling The Ground Using Float (SJC - 'ISO' Pattern)	119
Digging And Filling A Hole (SJC - 'ISO' Pattern)	120



TOWING THE LOADER121
 Procedure121

LIFTING THE LOADER121
 Single-Point Lift121
 Four-Point Lift122

TRANSPORTING THE LOADER ON A TRAILER123
 Loading And Unloading123
 Fastening123

INSTRUMENT PANEL IDENTIFICATION

Overview

Figure 6



The left panel [Figure 6] is described in more detail. (See Left Panel on Page 42.)

Figure 7

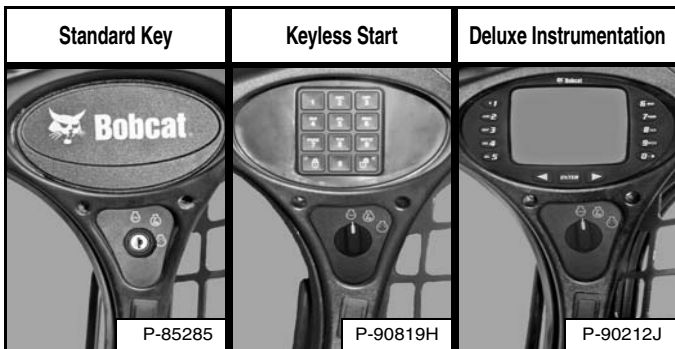

The right panel [Figure 7] is described in more detail. (See Right Panel (Standard Key Panel) on Page 46.), (See Right Panel (Keyless Start Panel) on Page 47.) or (See Right Panel (Deluxe Instrumentation Panel) on Page 48.)

Figure 8

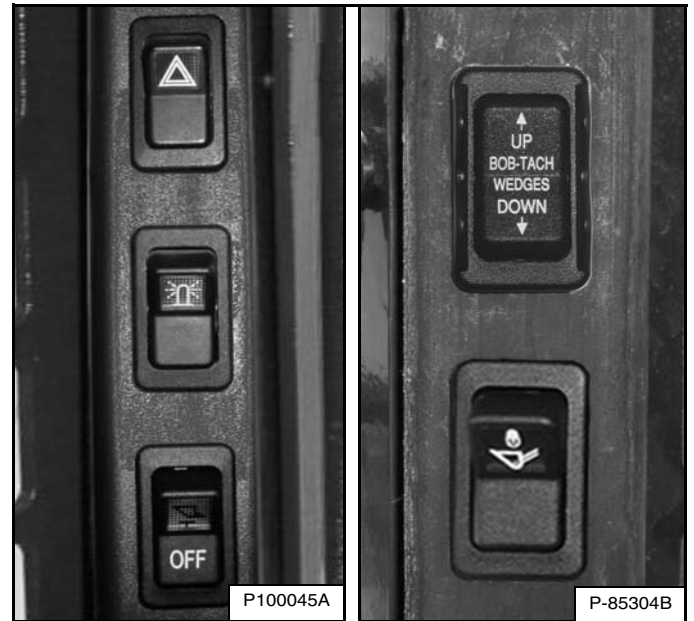

The left and right switch panels [Figure 8] are described in more detail. (See Left Switch Panel on Page 50.) and (See Right Switch Panel on Page 50.)

Figure 9

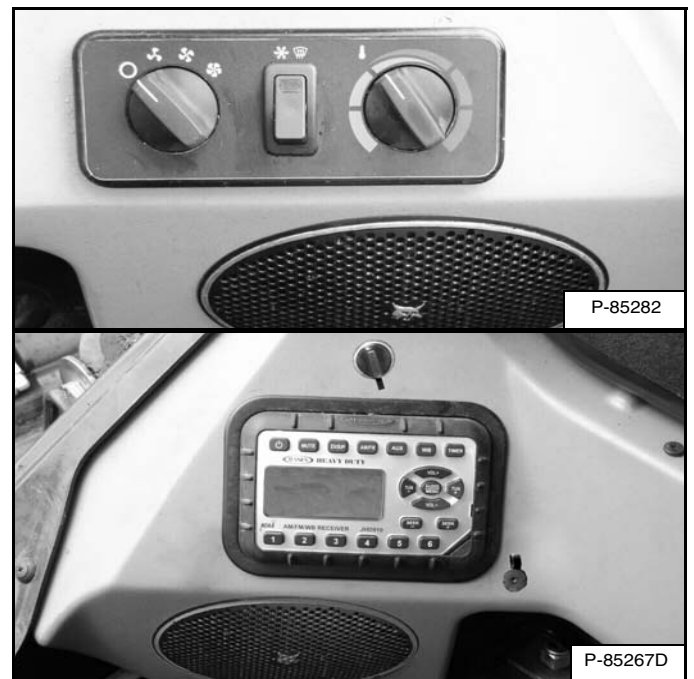

The left and right side lower panels [Figure 9] are described in more detail. (See Left Side Lower Panel on Page 51.) and (See Right Side Lower Panel on Page 51.)

INSTRUMENT PANEL IDENTIFICATION (CONT'D)

Left Panel

Figure 10



The left instrument panel [Figure 10] is the same for Standard Key Panel, Keyless Start Panel and Deluxe Instrumentation Panel equipped machines.

The table on the facing page shows the DESCRIPTION and FUNCTION / OPERATION for each of the components of the left panel.



INSTRUMENT PANEL IDENTIFICATION (CONT'D)

Left Panel (Cont'd)

REF. NO.	DESCRIPTION	FUNCTION / OPERATION
1	ENGINE TEMPERATURE GAUGE	Shows the engine coolant temperature.
2	LEFT TURN SIGNAL (Option)	Indicates left turn signals are ON.
3	GENERAL WARNING	Malfunction with one or more machine functions. (See Service Codes*)
4	TWO-SPEED (Option)	High range selected.
5	ENGINE MALFUNCTION	Engine malfunction or failure. (See Service Codes*)
6	ENGINE COOLANT TEMPERATURE	Engine coolant temperature high or sensor error.
7	DISPLAY SCREEN	Displays information. (See Display Screen in this manual.)
8	SEAT BELT	Instructs operator to fasten seat belt. Remains lit for 45 seconds.
9	SEAT BAR	The light comes on when the seat bar is UP.
10	LIFT & TILT VALVE	The light comes on when the lift and tilt functions cannot be operated.
11	PARKING BRAKE	The light comes on when the loader cannot be driven.
12	RIGHT TURN SIGNAL (Option)	Indicates right turn signals are ON.
13	SHOULDER BELT (Option)	Instructs operator to fasten shoulder belt when operating in high range. Remains lit while in high range.
14	HYDRAULIC SYSTEM MALFUNCTION	Hydraulic system malfunction or failure. (See Service Codes*)
15	FUEL	Fuel level low or sensor error.
16	FUEL GAUGE	Shows the amount of fuel in the tank.
17	LIGHTS - Without Road Option - With Road Option - All Loaders	Press once for REAR taillights. (Right green LED will light.) Press a second time to turn FRONT and REAR work lights ON. REAR taillights will turn OFF. (Left green LED will light.) Press a third time to turn all lights off. (Left and right green LEDs will be off.) Press once for FRONT boom light, license plate light and REAR taillights. (Right green LED will light.) Press a second time to turn FRONT and REAR work lights ON. FRONT boom light, license plate light and REAR taillights will turn OFF. (Left green LED will light.) Press a third time to turn all lights off. (Left and right green LEDs will be off.) Press and hold five seconds to show software version in display screen.
18	HIGH-FLOW (Option)	Press once to engage the HIGH-FLOW auxiliary hydraulics. (Left green LED will light.) Press a second time to disengage.
19	AUXILIARY HYDRAULICS	Press once to activate the auxiliary hydraulic system. (Left green LED will light.) Press a second time to deactivate the system.

* See SYSTEM SETUP & ANALYSIS for Service Code description. (See DIAGNOSTIC SERVICE CODES on Page 187.)



INSTRUMENT PANEL IDENTIFICATION (CONT'D)

Left Panel (Cont'd)

REF. NO.	DESCRIPTION	FUNCTION / OPERATION
20	INFORMATION	Cycles through (after each button press): <ul style="list-style-type: none"> • Hourmeter (On startup) • Engine rpm • Battery voltage • Maintenance clock • Service codes*
21	TRACTION LOCK OVERRIDE	Functions only when the seat bar is raised and the engine is running. Press once to unlock the brakes. Allows you to use the steering levers or joystick(s) to move the loader forward or backward when using the backhoe attachment. (See TRACTION LOCK OVERRIDE in this manual.) Press a second time to lock the brakes.
22	PRESS TO OPERATE LOADER	Press to activate the BICS™ when the seat bar is down and operator is seated in operating position. Button will light. Press and hold three seconds to access Drive Response and Steering Drift Compensation adjustment menus. (See DRIVE RESPONSE and STEERING DRIFT COMPENSATION in this manual.)
23	PARKING BRAKE (Standard on all loaders)	Press the top to engage the Parking Brake. Press the bottom to disengage. (See PARKING BRAKE in this manual.)

* See SYSTEM SETUP & ANALYSIS for Service Code description. (See DIAGNOSTIC SERVICE CODES on Page 187.)



INSTRUMENT PANEL IDENTIFICATION (CONT'D)

Display Screen

The Display Screen can display the following information:

- Operating hours.
- Engine revolutions per minute (rpm).
- Speed management setting.
- Maintenance clock countdown.
- Battery voltage.
- Service codes.
- Engine preheat countdown.
- Steering drift compensation setting.
- Drive response setting.

Figure 11

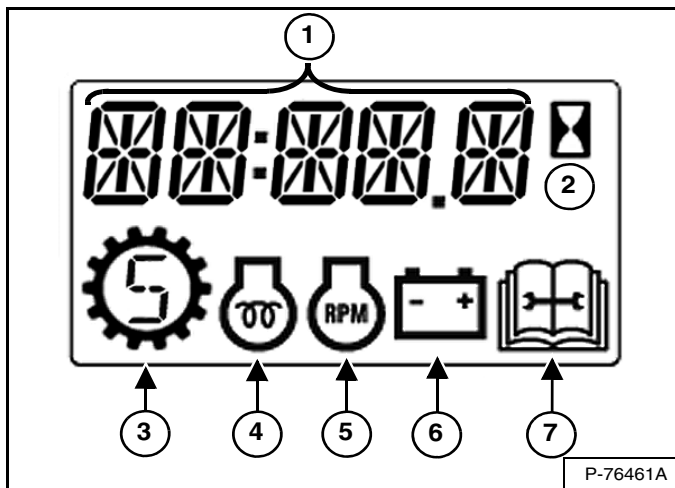

The display screen is shown in [Figure 11]. The data display will show operating hours upon startup.

1. **Data Display**
2. **Hourmeter**
3. **Speed Management**
4. **Engine Preheat**
5. **Engine Revolutions Per Minute**
6. **Battery / Charging Voltage**
7. **Service**

INSTRUMENT PANEL IDENTIFICATION (CONT'D)

Right Panel (Standard Key Panel)

Figure 12



This machine may be equipped with a Standard Key Panel [Figure 12].

The Standard Key Panel has a key switch (Item 1) [Figure 12] used to turn the loaders electrical system on and off, and to start and stop the engine.

The switch location (Item 2) [Figure 12] can have different functions depending on machine configuration. See the following table for more information.

REF.	DESCRIPTION	FUNCTION / OPERATION
	ADVANCED CONTROL SYSTEM (ACS) (Option)	Press the top to select Hand Controls; bottom to select Foot Controls.
	SELECTABLE JOYSTICK CONTROLS (SJC) (Option)	Press the top to select 'ISO' Control Pattern; bottom to select 'H' Control Pattern.
	FOUR-WAY FLASHER LIGHTS (Option)	Press the top to turn lights ON; bottom to turn OFF.
	ROTATING BEACON (Option) <i>or</i> STROBE LIGHT (Option)	Press the top to turn light ON; bottom to turn OFF.

INSTRUMENT PANEL IDENTIFICATION (CONT'D)

Right Panel (Keyless Start Panel)

Figure 13

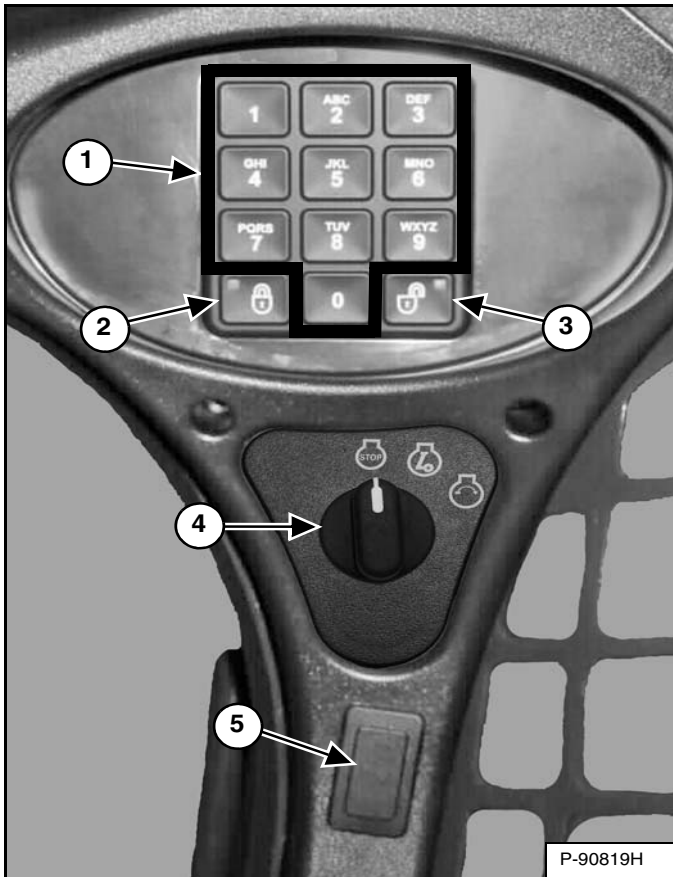

1. **Keypad (keys 1 through 0):** Used to enter a number code (password) to allow starting the engine. An asterisk will show in the left panel display screen for each key press.
2. **LOCK Key:** Used to lock keypad. The lock key will display a red light to indicate a password is required to start the loader. (See Password Lockout Feature on Page 195.)
3. **UNLOCK Key:** Used to unlock keypad. The unlock key will display a green light to indicate the loader can be started without a password. (See Password Lockout Feature on Page 195.)
4. **Key Switch:** Used to turn the loaders electrical system on and off, and to start and stop the engine.

The switch location (Item 5) [Figure 13] can have different functions depending on machine configuration. See the following table for more information.

REF.	DESCRIPTION	FUNCTION / OPERATION
	ADVANCED CONTROL SYSTEM (ACS) (Option)	Press the top to select Hand Controls; bottom to select Foot Controls.
	SELECTABLE JOYSTICK CONTROLS (SJC) (Option)	Press the top to select 'ISO' Control Pattern; bottom to select 'H' Control Pattern.
	FOUR-WAY FLASHER LIGHTS (Option)	Press the top to turn lights ON; bottom to turn OFF.
	ROTATING BEACON (Option) <i>or</i> STROBE LIGHT (Option)	Press the top to turn light ON; bottom to turn OFF.

Figure 14



Earlier models used a push button switch assembly [Figure 14] instead of a key switch.

INSTRUMENT PANEL IDENTIFICATION (CONT'D)

Right Panel (Deluxe Instrumentation Panel)

Figure 15

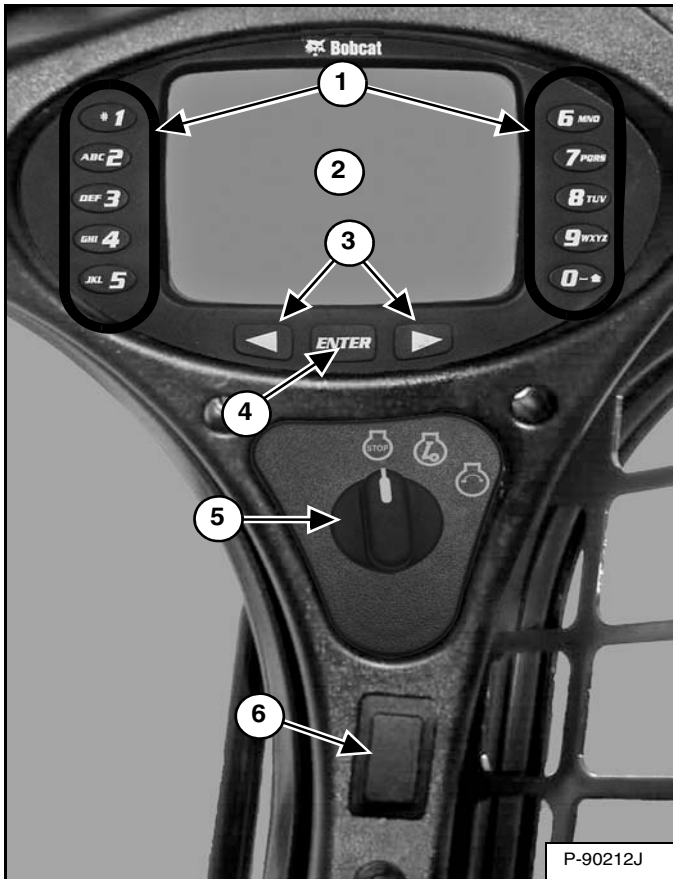

This machine may be equipped with a Deluxe Instrumentation Panel [Figure 15].

1. **Keypad (1 through 0):** The keypad has two functions:
 - To enter a number code (password) to allow starting the engine.
 - To enter a number as directed for further use of the display screen.
2. **Display Screen:** The Display Screen is where all system setup, monitoring and error conditions are displayed.
3. **Scroll Buttons:** Used to scroll through display screen choices.
4. **ENTER Button:** Used to make selections on the display screen.
5. **Key Switch:** Used to turn the loaders electrical system on and off, and to start and stop the engine.

The switch location (Item 6) [Figure 15] can have different functions depending on machine configuration. See the following table for more information.





REF.	DESCRIPTION	FUNCTION / OPERATION
	ADVANCED CONTROL SYSTEM (ACS) (Option)	Press the top to select Hand Controls; bottom to select Foot Controls.
	SELECTABLE JOYSTICK CONTROLS (SJC) (Option)	Press the top to select 'ISO' Control Pattern; bottom to select 'H' Control Pattern.
	FOUR-WAY FLASHER LIGHTS (Option)	Press the top to turn lights ON; bottom to turn OFF.
	ROTATING BEACON (Option) <i>or</i> STROBE LIGHT (Option)	Press the top to turn light ON; bottom to turn OFF.

Figure 16



Earlier models used a push button switch assembly [Figure 16] instead of a key switch.

INSTRUMENT PANEL IDENTIFICATION (CONT'D)

Right Panel (Deluxe Instrumentation Panel) (Cont'd)

Figure 17



The first screen you will see on your new loader will be as shown in [Figure 17].

When this screen is on the display you can enter the password and start the engine or change the default language.

NOTE: Your new loader (with Deluxe Instrumentation Panel) will have an Owner Password. Your dealer will provide you with this password. Change the password to one that you will easily remember to prevent unauthorised use of your loader. (See Changing The Owner Password on Page 196.) Keep your password in a safe place for future needs.

Change Language:

Press the left or right scroll button to cycle through the languages. The language that is stopped on will be the default language used for the deluxe instrumentation panel [Figure 17].

The language can be changed at any time. (See CONTROL PANEL SETUP on Page 193.)

Enter The Password:

Use the numbers on the keypad to enter the password, then press the [ENTER] button. A symbol will appear on the display screen for each number entered [Figure 17]. The left scroll button can be used to backspace if an incorrect number is entered.

If the correct password is not entered, [INVALID PASSWORD TRY AGAIN] will appear on the display screen and the password will have to be reentered.

See CONTROL PANEL SETUP for further description of screens to setup the system for your use. (See CONTROL PANEL SETUP on Page 193.)



INSTRUMENT PANEL IDENTIFICATION (CONT'D)

Left Switch Panel

Figure 18

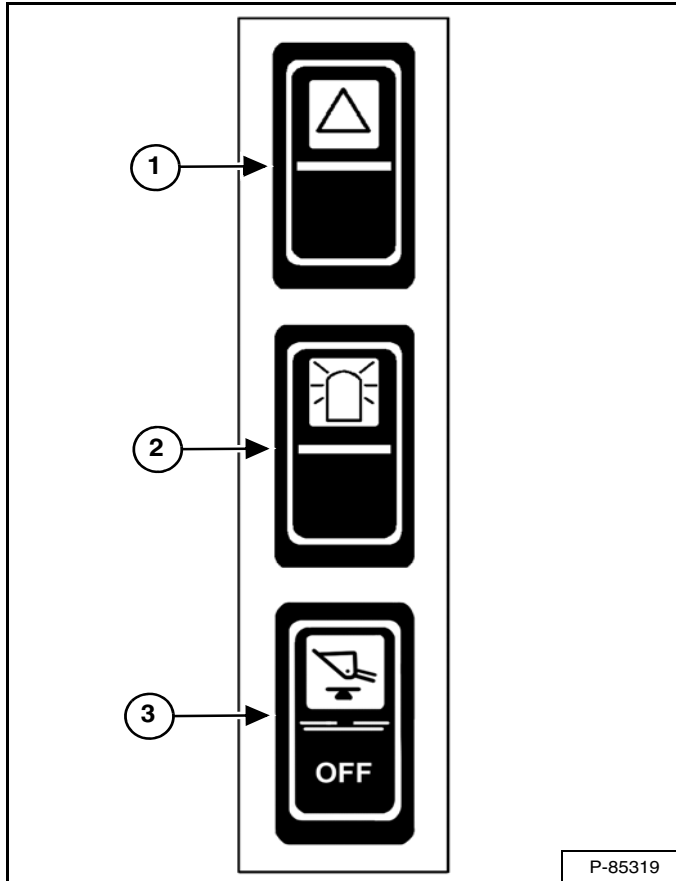

REF. NO.	DESCRIPTION	FUNCTION / OPERATION
1	FOUR-WAY FLASHER LIGHTS (Option)	Press the top to turn lights ON; bottom to turn OFF.
2	ROTATING BEACON (Option) <i>or</i> STROBE LIGHT (Option)	Press the top to turn light ON; bottom to turn OFF.
3	HYDRAULIC BUCKET POSITIONING (Option)	Press the top to engage Hydraulic Bucket Positioning; bottom to disengage.

Right Switch Panel

Figure 19

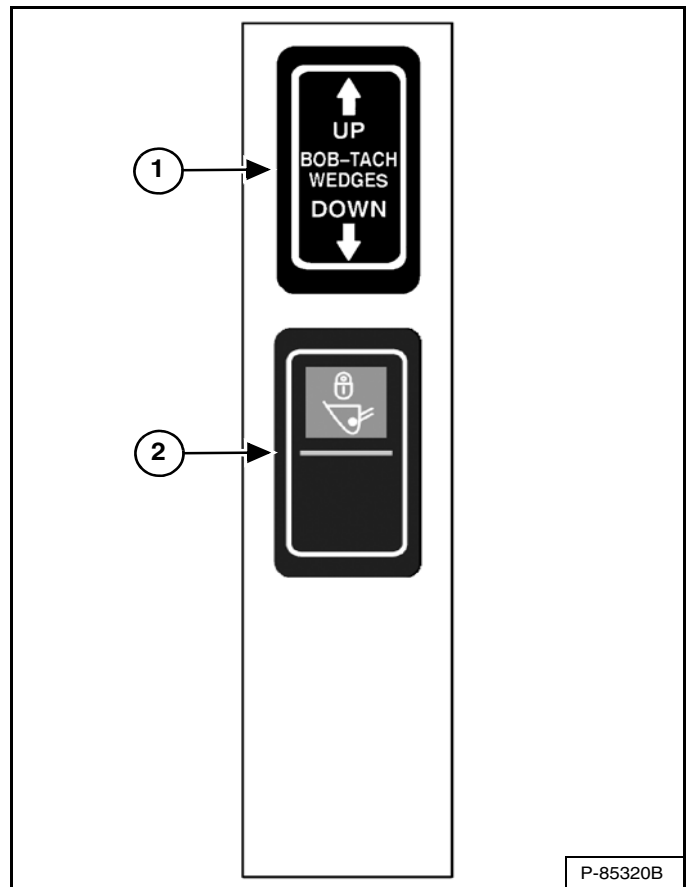

REF. NO.	DESCRIPTION	FUNCTION / OPERATION
1	POWER BOB-TACH (Option)	Press and hold the up arrow to disengage the Bob-Tach wedges. Press and hold the down arrow to engage the Bob-Tach wedges into the attachment mounting frame holes.
2	TRAVEL LOCK	Press the top of the switch to lock the lift and tilt hydraulic functions for travel. Press the bottom of the switch to turn travel lock OFF.



INSTRUMENT PANEL IDENTIFICATION (CONT'D)

Radio

This machine may be equipped with a Radio.

Figure 22

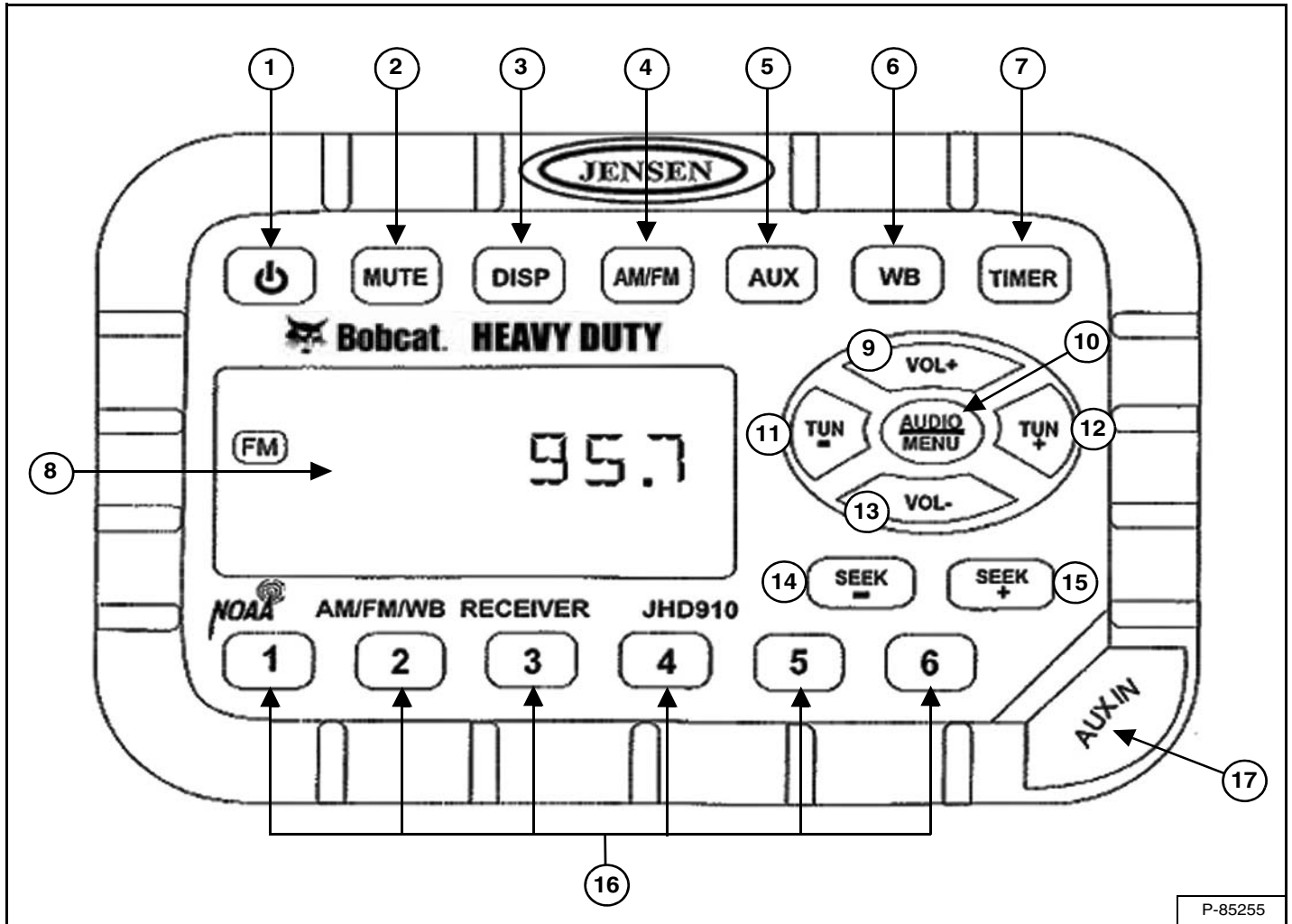

The table on the next page shows the DESCRIPTION and FUNCTION / OPERATION for each of the controls of the radio [Figure 22].

NOTE: See DISPLAY in the table for clock setting instructions.



INSTRUMENT PANEL IDENTIFICATION (CONT'D)

Radio (Cont'd)

REF. NO.	DESCRIPTION	FUNCTION / OPERATION
1	POWER	Press to turn ON; press again to turn OFF.
2	MUTE	Press to mute audio output; MUTE will appear in display screen; press again to turn OFF.
3	DISPLAY	Press to toggle between function mode (showing tuner frequency, auxiliary input, weather band information or timer) and clock mode. Press and hold to enter clock setting mode; use FREQUENCY DOWN button to adjust hours and FREQUENCY UP button to adjust minutes; normal operation will resume automatically.
4	BAND	Press to select tuner mode. Press to cycle through 2 AM (MW) bands and 3 FM bands.
5	AUXILIARY	Press to select Auxiliary Input mode. Portable audio device (MP3 player, etc.) must be attached to auxiliary input jack.
6	WEATHER BAND	Press to select weather band; use FREQUENCY UP and FREQUENCY DOWN buttons to adjust to the clearest station. The weather alert feature, if activated, will automatically switch from the current function to the weather band if a weather warning is received. See AUDIO / MENU ADJUSTMENT in this table.
7	TIMER	Press to access timer mode. Press to start the timer function; press again to stop timer; press again to resume timer or press and hold to reset timer and exit from timer mode.
8	DISPLAY SCREEN	Displays the time, frequency and activated functions.
9	VOLUME UP	Adjusts volume up; current volume (0 - 40) will appear briefly in display screen.
10	AUDIO / MENU ADJUSTMENT	AUDIO ADJUSTMENT: Press to cycle through bass, treble and balance settings; use VOLUME UP and VOLUME DOWN to adjust when desired option is displayed; normal operation will resume automatically. MENU ADJUSTMENT: Press and hold for three seconds to enter menu adjustment settings; press to cycle through the following settings; use VOLUME UP and VOLUME DOWN to adjust when desired option is displayed; normal operation will resume automatically. <ul style="list-style-type: none"> • Beep Confirm (On or Off) - Determines if beep will sound with each button press. • Operation Region (USA or Europe) - Selects the appropriate region. • Clock Display (12 or 24) - Selects a 12-hour or 24-hour clock display. • Display Brightness (Low, Medium or High) - Determines brightness level of display screen. • Backlight Colour (Amber or Green) - Determines backlight colour of display screen. • Power On Volume (0 - 40) - Selects default volume setting when radio is turned on. • WB Alert (On or Off) - Determines if weather band alert feature is activated.
11	FREQUENCY DOWN	Press to manually tune the radio frequency down.
12	FREQUENCY UP	Press to manually tune the radio frequency up.
13	VOLUME DOWN	Adjusts volume down; current volume (0 - 40) will appear briefly in display screen.
14	SEEK FREQUENCY DOWN	Press to automatically tune frequency down to next strong station.
15	SEEK FREQUENCY UP	Press to automatically tune frequency up to next strong station.
16	PRESET STATIONS	Used to store and recall stations for each AM and FM band. Press and hold to store current station; press button to recall station.
17	AUXILIARY INPUT JACK	Connect line output of portable audio device (MP3 player, etc.) to 3,5 mm (1/8 in) jack and press AUXILIARY button.

CONTROL IDENTIFICATION

This loader has four control configurations available to operate lift / tilt functions and driving / steering the loader:

- Standard Controls - Uses foot pedals for lift and tilt functions.
Uses steering levers for driving and steering the loader.
- Advanced Control System (ACS) (Option) - Uses a choice of foot pedals or handles for lift and tilt functions.
Uses steering levers for driving and steering the loader.
- Advanced Hand Controls (AHC) (Option) - Uses handles for lift and tilt functions.
Uses steering levers for driving and steering the loader.
- Selectable Joystick Controls (SJC) (Option) - Uses joysticks for lift / tilt functions and driving / steering the loader.

Standard Controls

Figure 23

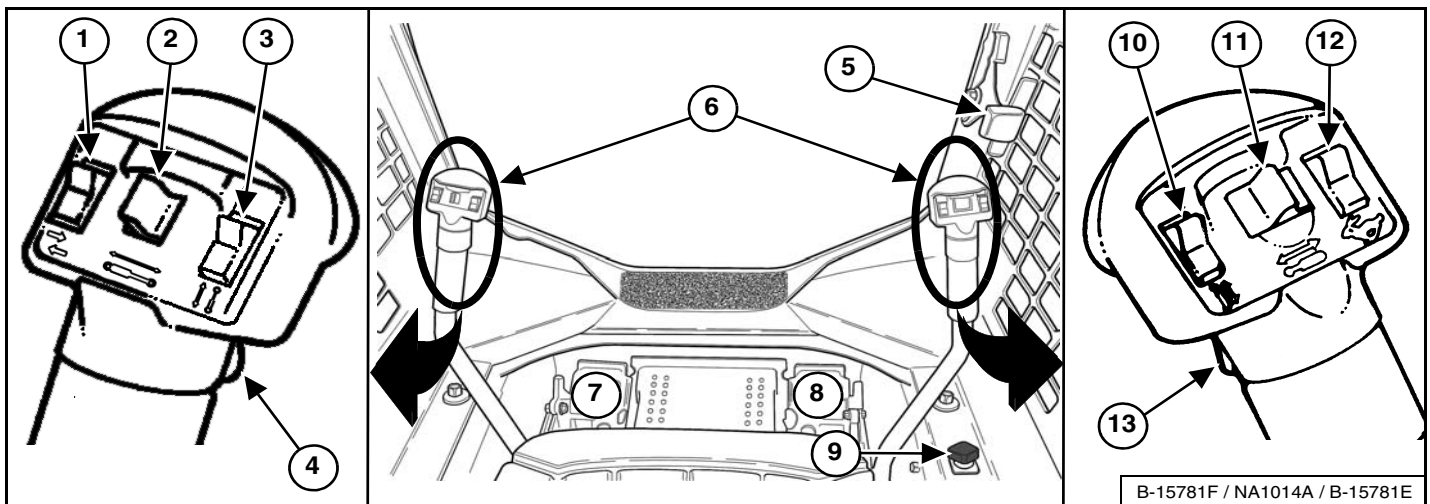

REF. NO.	DESCRIPTION	FUNCTION / OPERATION
1	TURN SIGNALS (Option)	Press the top to activate right signal; bottom to activate left signal; centre position to turn off.
2	REAR AUXILIARY HYDRAULICS (Option) Also: ATTACHMENT FUNCTION CONTROL	See REAR Auxiliary Hydraulics Operation in this manual. See ATTACHMENT CONTROL DEVICE in this manual.
3	ATTACHMENT FUNCTION CONTROL	See ATTACHMENT CONTROL DEVICE in this manual.
4	FRONT HORN	Press the front switch to sound the front horn.
5	ENGINE SPEED CONTROL	See ENGINE SPEED CONTROL in this manual.
6	STEERING LEVERS	See DRIVING AND STEERING THE LOADER in this manual.
7	LIFT ARM PEDAL	See HYDRAULIC CONTROLS in this manual.
8	TILT PEDAL	See HYDRAULIC CONTROLS in this manual.
9	LIFT ARM BYPASS CONTROL	See LIFT ARM BYPASS CONTROL in this manual.
10	ATTACHMENT FUNCTION CONTROL	See ATTACHMENT CONTROL DEVICE in this manual.
11	FRONT AUXILIARY HYDRAULICS	See FRONT Auxiliary Hydraulics Operation in this manual.
12	TWO-SPEED CONTROL (Option)	See TWO-SPEED CONTROL in this manual.
13	CONTINUOUS FLOW CONTROL FOR AUXILIARY HYDRAULICS	See FRONT Auxiliary Hydraulics Operation (CONTINUOUS FLOW) in this manual.

CONTROL IDENTIFICATION (CONT'D)

Advanced Control System (ACS)

Figure 24

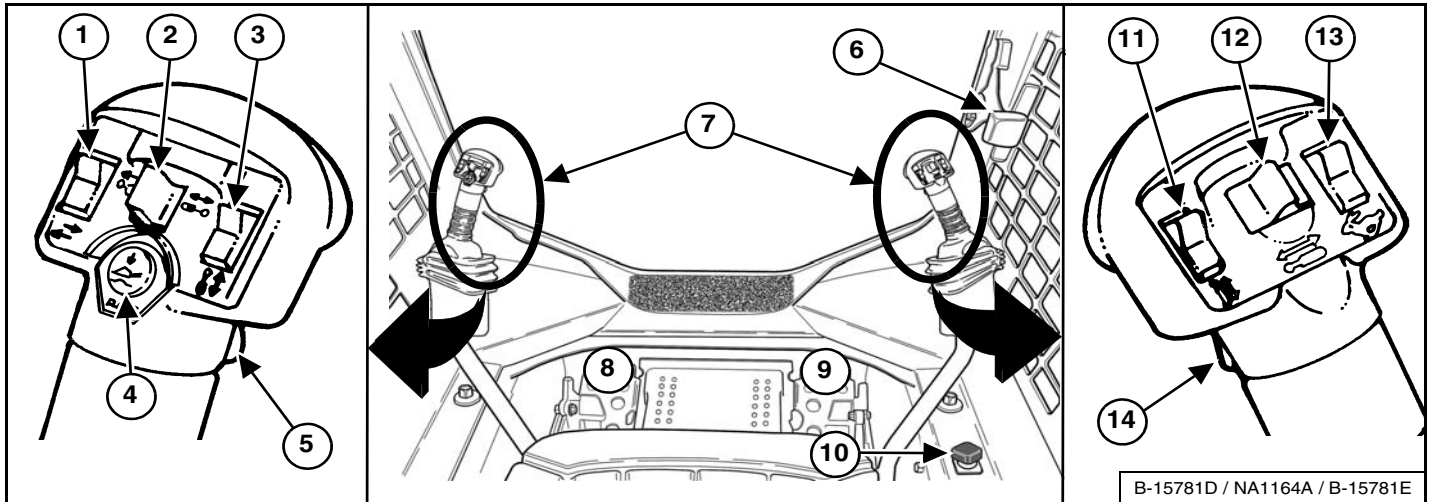

REF. NO.	DESCRIPTION	FUNCTION / OPERATION
1	TURN SIGNALS (Option)	Press the top to activate right signal; bottom to activate left signal; centre position to turn off.
2	REAR AUXILIARY HYDRAULICS (Option) Also: ATTACHMENT FUNCTION CONTROL	See REAR Auxiliary Hydraulics Operation in this manual. See ATTACHMENT CONTROL DEVICE in this manual.
3	ATTACHMENT FUNCTION CONTROL	See ATTACHMENT CONTROL DEVICE in this manual.
4	FLOAT CONTROL	See HYDRAULIC CONTROLS in this manual.
5	FRONT HORN	Press the front switch to sound the front horn.
6	ENGINE SPEED CONTROL	See ENGINE SPEED CONTROL in this manual.
7	STEERING LEVERS AND LIFT / TILT HANDLES	See DRIVING AND STEERING THE LOADER and HYDRAULIC CONTROLS in this manual.
8	LIFT ARM PEDAL	See HYDRAULIC CONTROLS in this manual.
9	TILT PEDAL	See HYDRAULIC CONTROLS in this manual.
10	LIFT ARM BYPASS CONTROL	See LIFT ARM BYPASS CONTROL in this manual.
11	ATTACHMENT FUNCTION CONTROL	See ATTACHMENT CONTROL DEVICE in this manual.
12	FRONT AUXILIARY HYDRAULICS	See FRONT Auxiliary Hydraulics Operation in this manual.
13	TWO-SPEED CONTROL (Option)	See TWO-SPEED CONTROL in this manual.
14	CONTINUOUS FLOW CONTROL FOR AUXILIARY HYDRAULICS	See FRONT Auxiliary Hydraulics Operation (CONTINUOUS FLOW) in this manual.



CONTROL IDENTIFICATION (CONT'D)

Advanced Hand Controls (AHC)

Figure 25

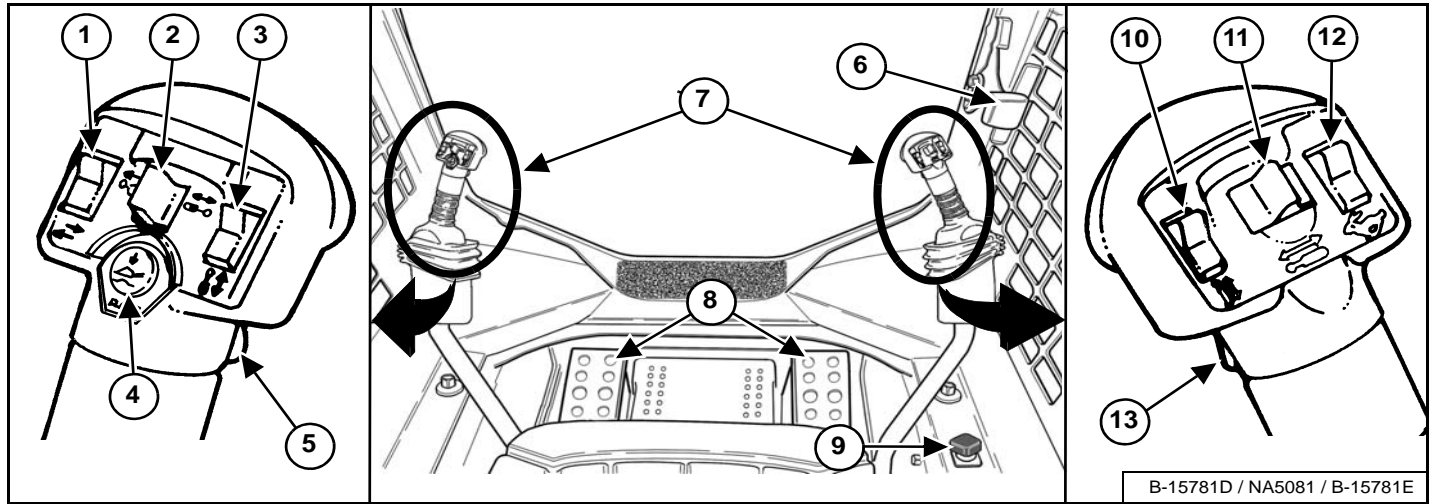

REF. NO.	DESCRIPTION	FUNCTION / OPERATION
1	TURN SIGNALS (Option)	Press the top to activate right signal; bottom to activate left signal; centre position to turn off.
2	REAR AUXILIARY HYDRAULICS (Option) Also: ATTACHMENT FUNCTION CONTROL	See REAR Auxiliary Hydraulics Operation in this manual. See ATTACHMENT CONTROL DEVICE in this manual.
3	ATTACHMENT FUNCTION CONTROL	See ATTACHMENT CONTROL DEVICE in this manual.
4	FLOAT CONTROL	See HYDRAULIC CONTROLS in this manual.
5	FRONT HORN	Press the front switch to sound the front horn.
6	ENGINE SPEED CONTROL	See ENGINE SPEED CONTROL in this manual.
7	STEERING LEVERS AND LIFT / TILT HANDLES	See DRIVING AND STEERING THE LOADER and HYDRAULIC CONTROLS in this manual.
8	FOOTRESTS	Keep your feet on the footrests at all times.
9	LIFT ARM BYPASS CONTROL	See LIFT ARM BYPASS CONTROL in this manual.
10	ATTACHMENT FUNCTION CONTROL	See ATTACHMENT CONTROL DEVICE in this manual.
11	FRONT AUXILIARY HYDRAULICS	See FRONT Auxiliary Hydraulics Operation in this manual.
12	TWO-SPEED CONTROL (Option)	See TWO-SPEED CONTROL in this manual.
13	CONTINUOUS FLOW CONTROL FOR AUXILIARY HYDRAULICS	See FRONT Auxiliary Hydraulics Operation (CONTINUOUS FLOW) in this manual.



CONTROL IDENTIFICATION (CONT'D)

Selectable Joystick Controls (SJC)

Figure 26

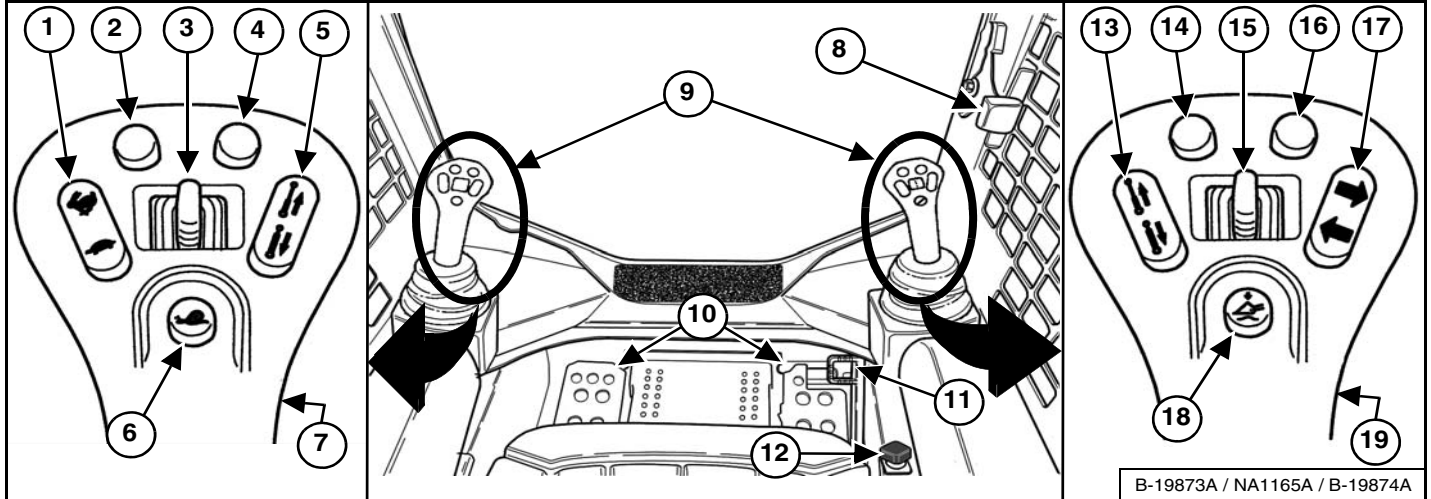

REF. NO.	DESCRIPTION	FUNCTION / OPERATION
1	TWO-SPEED CONTROL (Option) Also: SPEED MANAGEMENT	See TWO-SPEED CONTROL in this manual. See SPEED MANAGEMENT in this manual.
* 2	STEERING DRIFT COMPENSATION Also: DRIVE RESPONSE	See STEERING DRIFT COMPENSATION in this manual. See DRIVE RESPONSE in this manual.
3	REAR AUXILIARY HYDRAULICS (Option) Also: ATTACHMENT FUNCTION CONTROL	See REAR Auxiliary Hydraulics Operation in this manual. See ATTACHMENT CONTROL DEVICE in this manual.
* 4	STEERING DRIFT COMPENSATION Also: DRIVE RESPONSE	See STEERING DRIFT COMPENSATION in this manual. See DRIVE RESPONSE in this manual.
5	ATTACHMENT FUNCTION CONTROL	See ATTACHMENT CONTROL DEVICE in this manual.
6	SPEED MANAGEMENT	See SPEED MANAGEMENT in this manual.
7	FRONT HORN	Press the front switch to sound the front horn.
8	ENGINE SPEED CONTROL (HAND)	See ENGINE SPEED CONTROL in this manual.
9	JOYSTICKS	See DRIVING AND STEERING THE LOADER and HYDRAULIC CONTROLS in this manual.
10	FOOTRESTS	Keep your feet on the footrests at all times.
11	ENGINE SPEED CONTROL (FOOT)	See ENGINE SPEED CONTROL in this manual.
12	LIFT ARM BYPASS CONTROL	See LIFT ARM BYPASS CONTROL in this manual.
13	ATTACHMENT FUNCTION CONTROL	See ATTACHMENT CONTROL DEVICE in this manual.
* 14	NOT USED	- - -
15	FRONT AUXILIARY HYDRAULICS	See FRONT Auxiliary Hydraulics Operation in this manual.
* 16	NOT USED	- - -
17	TURN SIGNALS (Option)	Press the top to activate right signal; bottom to activate left signal; centre position to turn off.
18	FLOAT CONTROL	See HYDRAULIC CONTROLS in this manual.
19	CONTINUOUS FLOW CONTROL FOR AUXILIARY HYDRAULICS	See FRONT Auxiliary Hydraulics Operation (CONTINUOUS FLOW) in this manual.

* Also used as Attachment Function Control: See your attachment Operation & Maintenance Manual.

OPERATOR CAB

Description

The Bobcat loader has an operator cab (ROPS and FOPS) as standard equipment to protect the operator from rollover and falling objects. The seat belt must be worn for rollover protection.

WARNING

Never modify operator cab by welding, grinding, drilling holes or adding attachments unless instructed to do so by Bobcat Company. Changes to the cab can cause loss of operator protection from rollover and falling objects, and result in injury or death.

W-2069-0200

Cab Light

Figure 27



The Cab Light [Figure 27] is located above the operator's left shoulder.

Push this side of the switch (Item 1) to turn the light ON. Place the switch in the middle position (Item 2) to turn the light OFF. Push this side of the switch (Item 3) [Figure 27] to turn the light ON and OFF with the door.

Door Operation

This machine may be equipped with a Front Door.

Figure 28

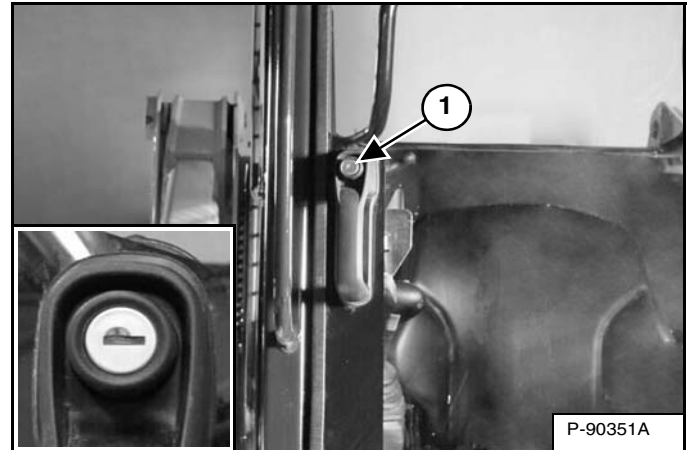

Push the knob (Item 1) and pull the handle to open the front door. A lock is provided in the knob (Inset) [Figure 28] to lock the front door when the loader is not in use.

Figure 29

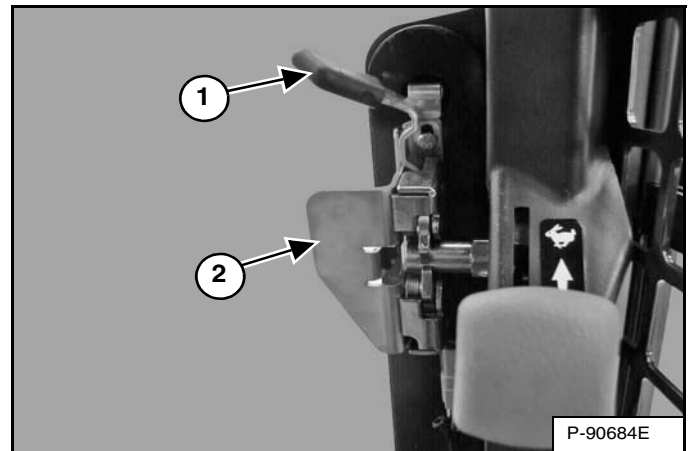

Pull the front door closed using the handle (Item 2) [Figure 29].

Pull the lever (Item 1) toward you to unlatch the front door. Push on the handle (Item 2) [Figure 29] to open the front door.

OPERATOR CAB (CONT'D)

Front Wiper

Figure 30

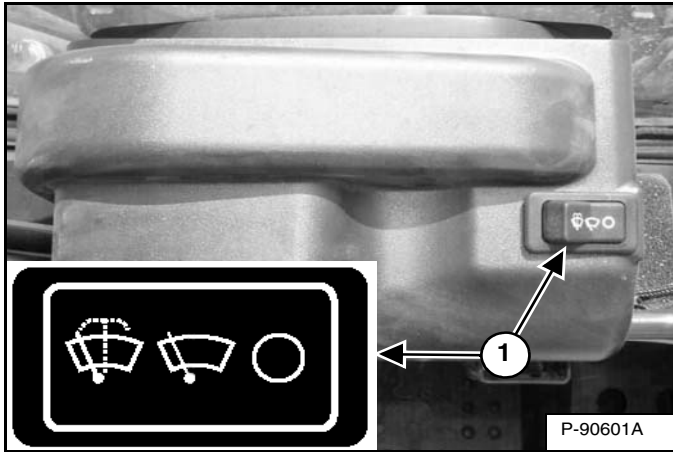

This machine may be equipped with a Front Wiper [Figure 30].

Press the left side of the switch (Item 1) [Figure 30] to start the front wiper (press and hold for washer fluid). Press the right side of the switch to stop the wiper.

Figure 31

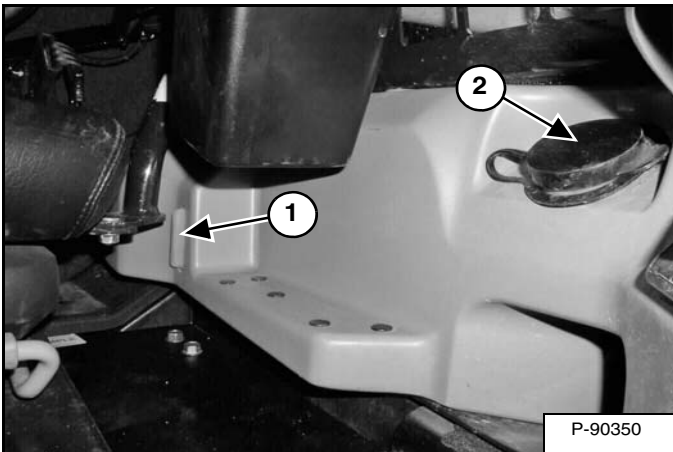

The washer fluid tank is located on the left side of the operator cab. Check the fluid level in the sight gauge (Item 1). Remove the cap (Item 2) [Figure 31] to add washer fluid.

Side Windows

Figure 32

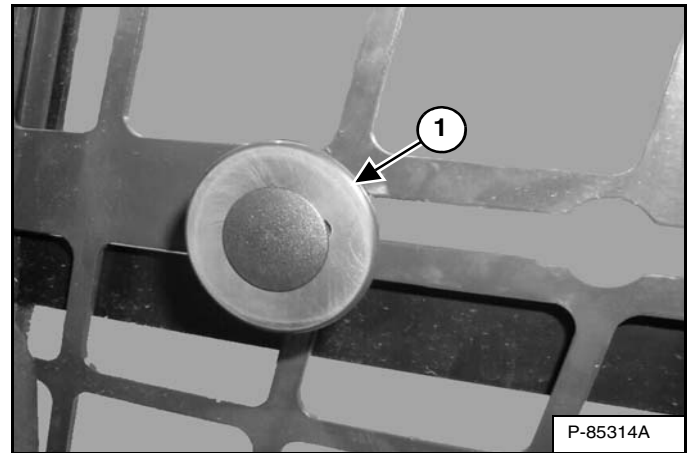

Pull the knob (Item 1) [Figure 32] and slide backward to open window. Release knob at cutout to lock in desired position. Pull the knob and slide forward to close window.

SEAT BAR RESTRAINT SYSTEM

Operation

Figure 33

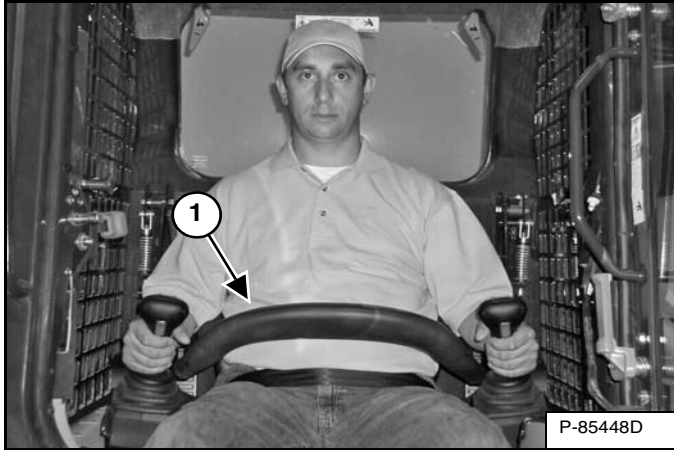

The Seat Bar Restraint System has a pivoting seat bar with armrests (Item 1) [Figure 33].

The operator controls the use of the seat bar. The seat bar in the down position helps to keep the operator in the seat.

! WARNING

AVOID INJURY OR DEATH

When operating the machine:

- Keep the seat belt fastened snugly.
- The seat bar must be lowered.
- Keep your feet on the pedal controls or footrests and hands on the controls.

W-2261-0909

When the seat bar is down, the engine is running, the PRESS TO OPERATE LOADER button is activated, and the brake is released, the lift, tilt, and traction drive functions can be operated.

When the seat bar is raised, the lift, tilt and traction drive functions are deactivated and both foot pedals (if equipped) will be locked when returned to neutral position.

! WARNING

AVOID INJURY OR DEATH

Before you leave the operator's seat:

- Lower the lift arms and put the attachment flat on the ground.
- Stop the engine.
- Engage the parking brake.
- Raise the seat bar.
- Move all controls to the NEUTRAL / LOCKED position to make sure the lift, tilt and traction drive functions are deactivated.

The seat bar system must deactivate these functions when the seat bar is up. See your Bobcat dealer for service if controls do not deactivate.

W-2463-1110

BOBCAT INTERLOCK CONTROL SYSTEM (BICS™)

Operation



AVOID INJURY OR DEATH

The Bobcat Interlock Control System (BICS) must deactivate the lift, tilt and traction drive functions. If it does not, contact your dealer for service. **DO NOT** modify the system.

W-2151-0394

Figure 34

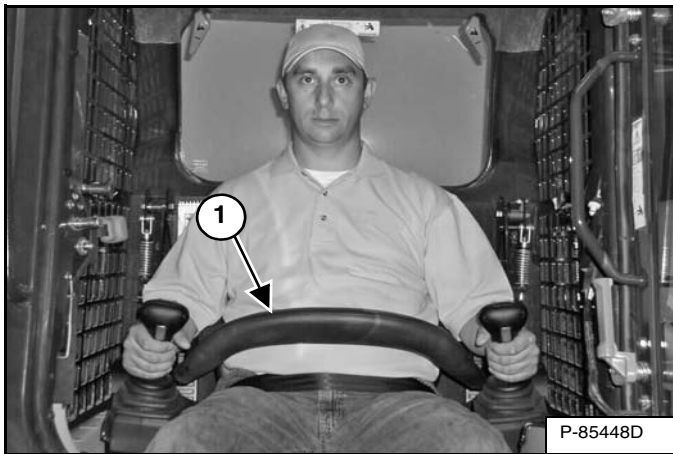

The Bobcat Interlock Control System (BICS™) has a pivoting seat bar with armrests (Item 1) [Figure 34]. The operator controls the use of the seat bar.

The BICS™ requires the operator to be seated in the operating position with the seat bar fully lowered before the lift, tilt, auxiliary hydraulics, and traction drive functions can be operated. The seat belt must be fastened anytime you operate the machine.



AVOID INJURY OR DEATH

When operating the machine:

- Keep the seat belt fastened snugly.
- The seat bar must be lowered.
- Keep your feet on the pedal controls or footrests and hands on the controls.

W-2261-0909

Figure 35



There are three display lights (Items 1, 2 and 3) [Figure 35] located on the left instrument panel that must be OFF to fully operate the machine.

When the seat bar is lowered, the engine is running, the PRESS TO OPERATE LOADER button is activated, and the parking brake is released, the lift, tilt, auxiliary hydraulics, and traction drive functions can be operated.

When, the seat bar is raised, the lift, tilt, auxiliary hydraulics, and traction drive functions are deactivated.



AVOID INJURY OR DEATH

Before you leave the operator's seat:

- Lower the lift arms and put the attachment flat on the ground.
- Stop the engine.
- Engage the parking brake.
- Raise the seat bar.
- Move all controls to the NEUTRAL / LOCKED position to make sure the lift, tilt and traction drive functions are deactivated.

The seat bar system must deactivate these functions when the seat bar is up. See your Bobcat dealer for service if controls do not deactivate.

W-2463-1110

LIFT ARM BYPASS CONTROL

Operation

Figure 36

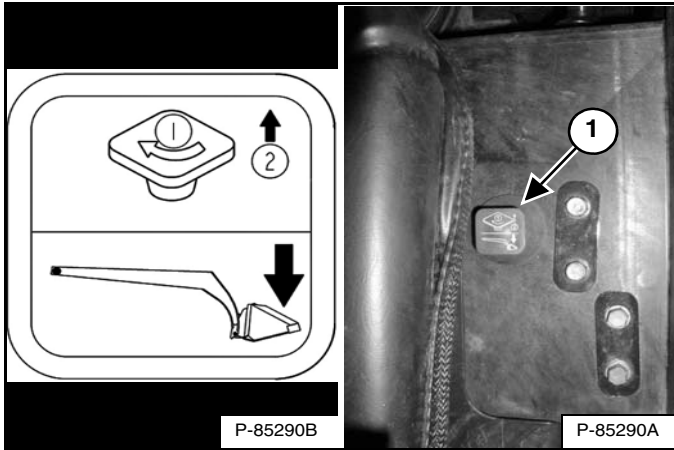

The Lift Arm Bypass Control (Item 1) [Figure 36], located to the right of the operator's seat, is used to lower the lift arms if the lift arms cannot be lowered during normal operations.

1. Sit in the operator's seat.
2. Fasten the seat belt and lower the seat bar.
3. Turn the knob (Item 1) [Figure 36] 90° clockwise.
4. Pull up and hold the knob until the lift arms lower.

PARKING BRAKE

Operation

Figure 37

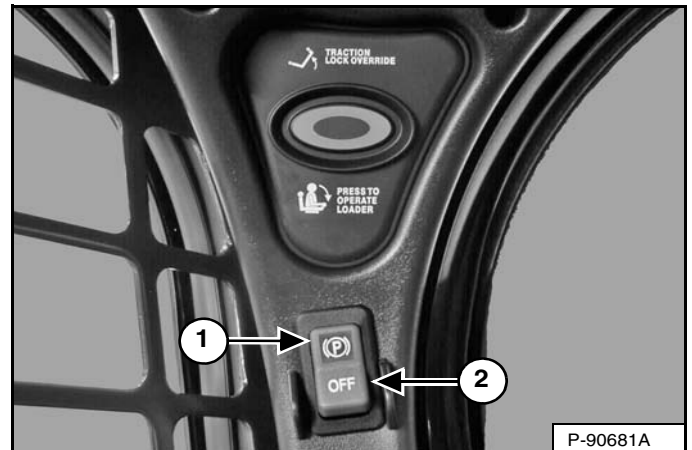

Press the top of the switch (Item 1) [Figure 37] to engage the parking brake. The red light in the switch will turn on. The traction drive system will be locked.

Press the bottom of the switch (Item 2) [Figure 37] to disengage the parking brake. The red light in the switch will turn off. The traction drive system will be unlocked.

NOTE: The **PARKING BRAKE** light on the left instrument panel will remain **ON** until the engine is started, the **PRESS TO OPERATE LOADER** button is pressed and the parking brake is disengaged.

TRACTION LOCK OVERRIDE

Operation

Figure 38

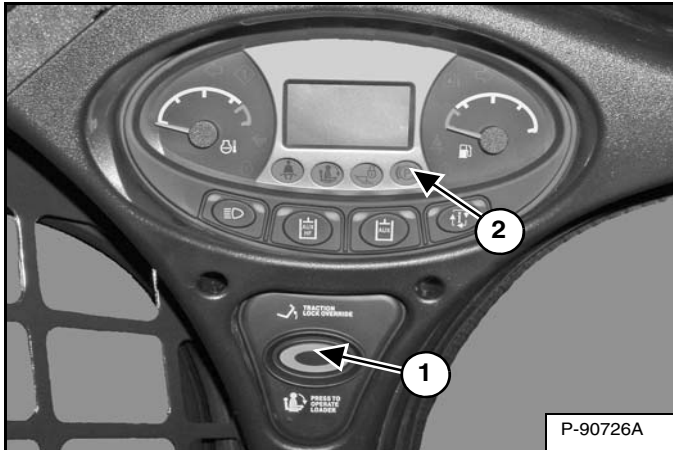

(Functions Only When The Seat Bar Is Raised And The Engine Is Running) There is a TRACTION LOCK OVERRIDE button (Item 1) [Figure 38] on the left instrument panel which will allow you to use the steering levers to move the loader forward and backward when using the backhoe attachment.

- Press the TRACTION LOCK OVERRIDE button once to unlock traction drive. The PARKING BRAKE light (Item 2) [Figure 38] will be OFF.
- Press the button a second time to lock the traction drive. The PARKING BRAKE light (Item 2) [Figure 38] will be ON.

NOTE: The TRACTION LOCK OVERRIDE button will unlock the traction drive when the seat bar is raised and the engine is running.

NOTE: The TRACTION LOCK OVERRIDE button will function if the parking brake is in the engaged or disengaged position and the engine is running. If the parking brake switch is turned ON, the red light in the parking brake switch will turn OFF when TRACTION LOCK OVERRIDE is engaged.

ENGINE SPEED CONTROL

Operation

Figure 39

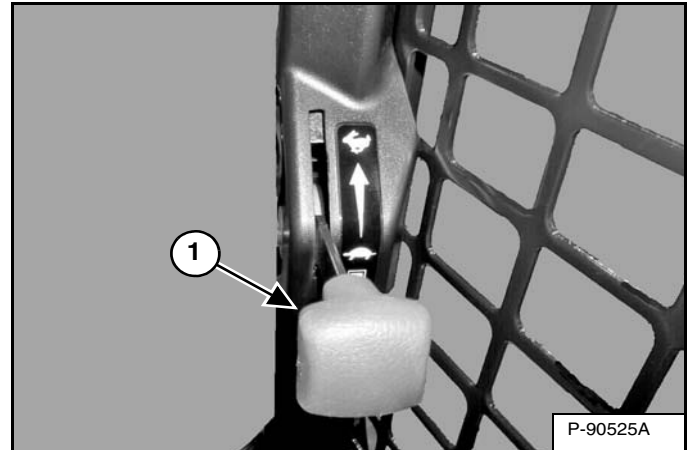

The Engine Speed Control lever (Item 1) [Figure 39] is located alongside the door frame below the right panel.

Move the lever up to increase engine speed. Move down to decrease engine speed.

Figure 40

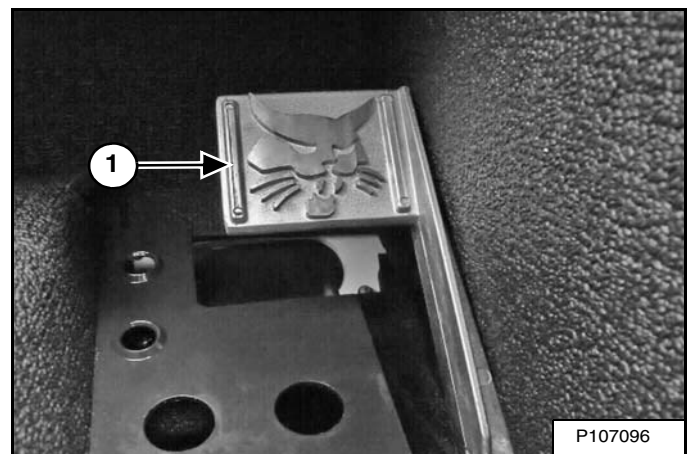

There is a foot operated engine speed control pedal (Item 1) [Figure 40] in addition to the engine speed control lever on SJC equipped machines. It is located on the right side floor above the footrest.

EMERGENCY EXIT

The front opening on the operator cab and rear window provide exits.

External Access

Figure 41

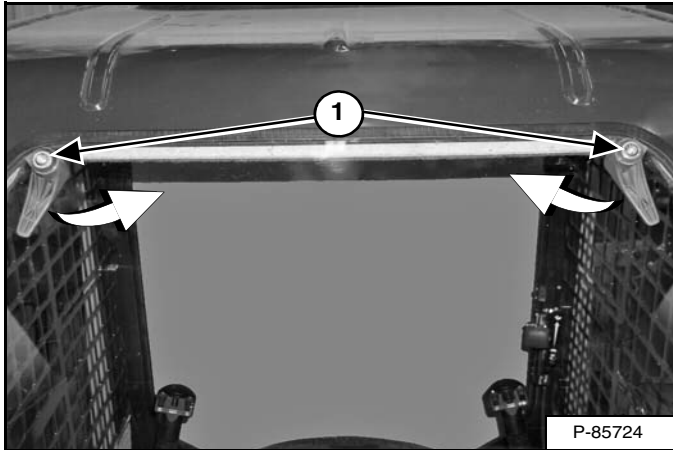

The rear window can be removed from outside the loader using a T40 TORX® driver. Turn both screws (Item 1) [Figure 41] in until the latches disengage from the window frame. Pull the top of the window away from the cab and lift up to remove.

Rear Window

NOTE: Use this procedure to remove the rear window only under emergency conditions. Damage to machine may occur.

Figure 42

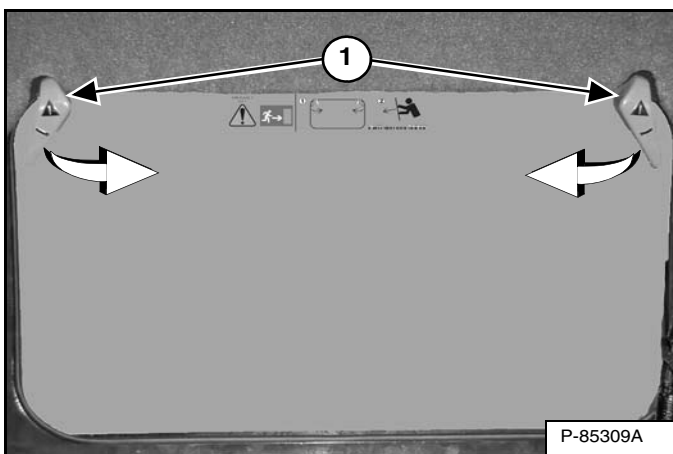

Turn both latches (Item 1) [Figure 42] in until they disengage from the window frame.

Push the rear window out of the rear of the operator cab.

Figure 43



Exit through the rear of the operator cab [Figure 43].

Front Door

This machine may be equipped with a Front Door.

NOTE: Use this procedure to remove the front door only under emergency conditions. Damage to machine may occur.

Figure 44

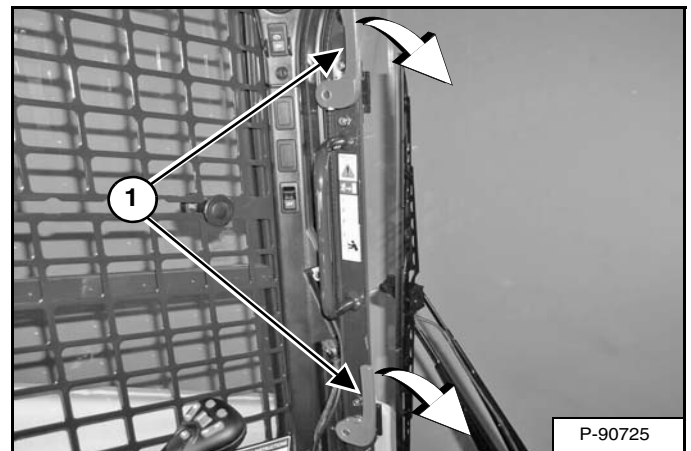

Turn both latches (Item 1) [Figure 44] down until they disengage from the door frame.

Push the door out of the operator cab door frame.

Exit through the opening.

EMERGENCY EXIT (CONT'D)

Front Door (Cont'd)

Front Door Reassembly

Reassemble the front door using the following instructions if the door was opened using the emergency exit procedure.

Figure 45

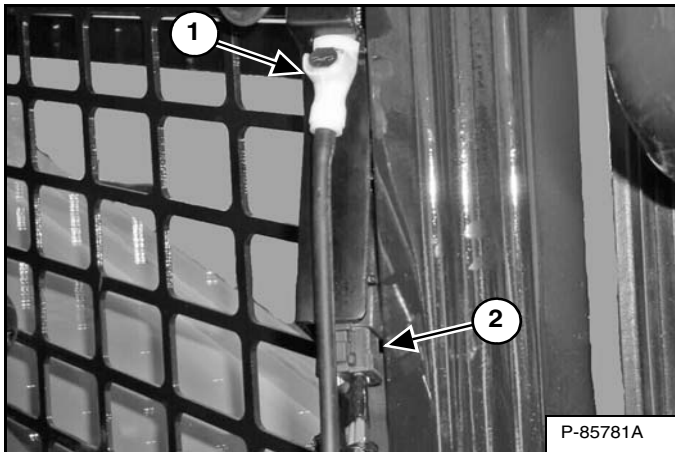

Disconnect electrical connector (Item 2) and washer fluid hose (Item 1) [Figure 45].

Figure 46

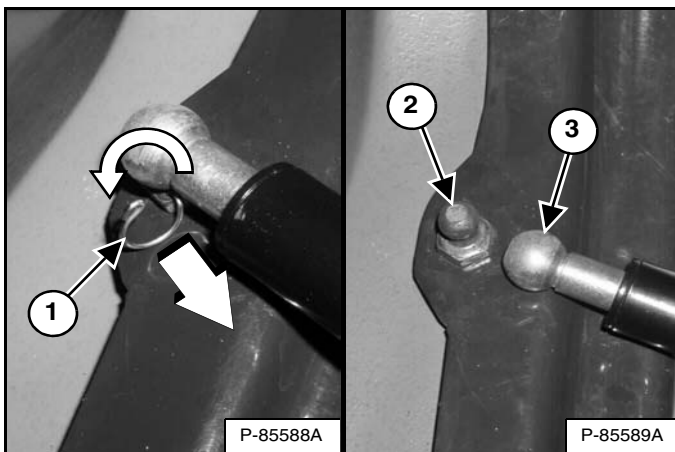

Rotate and pull the clip (Item 1) out of the gas spring socket. Pull the gas spring socket (Item 3) straight off the ball stud fitting (Item 2) [Figure 46].

Remove the door hinges from the loader.

Figure 47

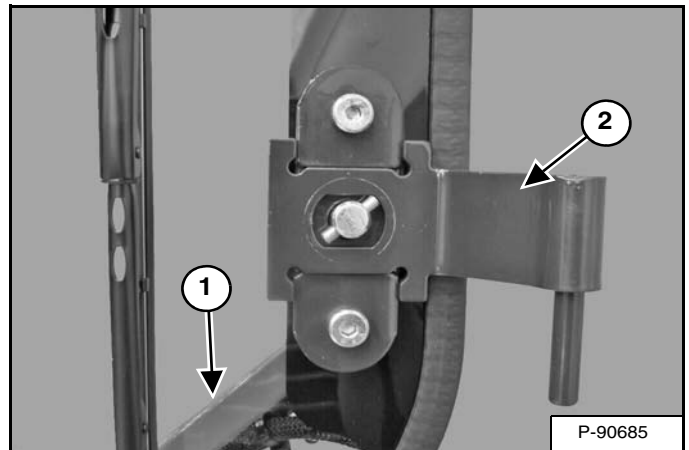

Orient the latches as shown (Item 1) and install the door hinges (Item 2) [Figure 47] on the door. (Bottom hinge shown)

Figure 48

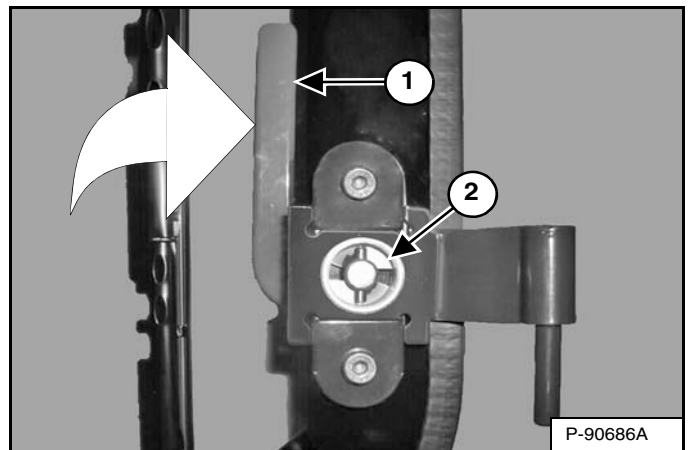

Install cast washers (Item 2) on door hinges taking care to match rectangular surfaces. Hold cast washer firmly against door and rotate latch (Item 1) [Figure 48] up to lock cast washer into place. (Bottom hinge shown)

Install door on loader.

Install the gas spring socket on the ball stud fitting. Install the clip into the hole in the gas spring socket. Rotate the clip to lock into place [Figure 46].

Connect electrical connector (Item 2) and washer fluid hose (Item 1) [Figure 45].

BACK-UP ALARM SYSTEM

This machine may be equipped with a Back-up Alarm.

Description

Figure 49

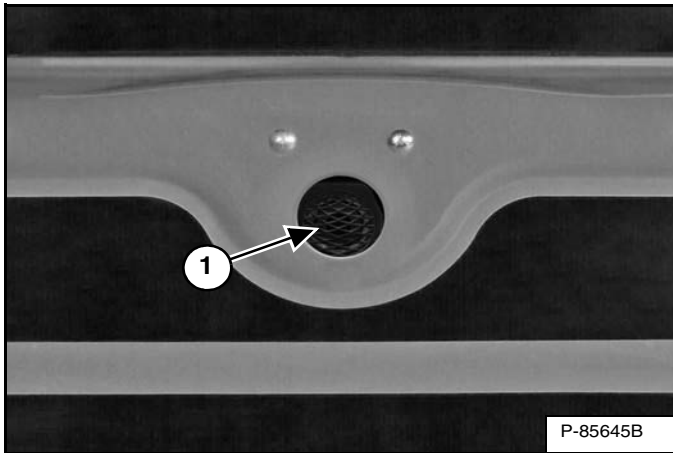

The back-up alarm (Item 1) [Figure 49] is located on the inside of the rear door.

A back-up alarm is not a substitute for looking to the rear when operating the loader in reverse, or for keeping bystanders away from the work area. Operators **must always** look in the direction of travel, including **reverse**, and must also keep bystanders away from the work area, even though the loader is equipped with a back-up alarm.

Operators must be trained to **always** look in the direction of travel, **including when operating the loader in reverse** and to keep bystanders away from the work area. Other workers should be trained to **always** keep away from the operator's work area and travel path.

Operation

! WARNING

AVOID INJURY OR DEATH

- Always keep bystanders away from the work area and travel path.
- The operator must always look in the direction of travel.
- The back-up alarm must sound when operating the machine in the reverse direction.

W-2783-0409

The back-up alarm will sound when the operator moves both steering levers or joystick(s) into the reverse position. Slight movement of the steering levers into the reverse position is required with hydrostatic transmissions, before the back-up alarm will sound.

If alarm does not sound or for adjustment instructions, see inspection and maintenance instructions for the back-up alarm system in the preventive maintenance section of this manual. (See BACK-UP ALARM SYSTEM on Page 139.)

DRIVING AND STEERING THE LOADER

Available Control Configurations

The loader has four configurations available:

- *Standard Controls* - Two Steering Levers control drive and steering functions.
- *Advanced Control System (ACS) (Option)* - Two Steering Levers control drive and steering functions.
- *Advanced Hand Controls (AHC) (Option)* - Two Steering Levers control drive and steering functions.
- *Selectable Joystick Controls (SJC) (Option)* -
 ('ISO' Pattern) Left joystick controls the drive and steering functions.
 ('H' Pattern) Left and right joysticks control left and right side drive and steering functions.

Operation (Standard, ACS And AHC)

Figure 50

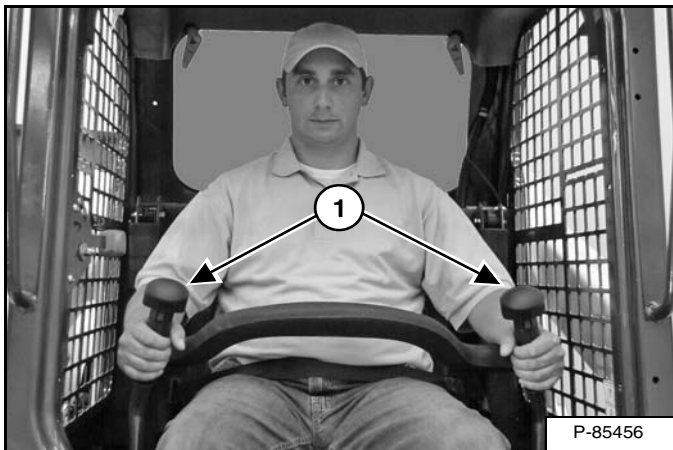

The steering levers (Item 1) [Figure 50] are on the left and right side in front of the seat.

Move the levers smoothly. Avoid sudden starting and stopping.

Figure 51

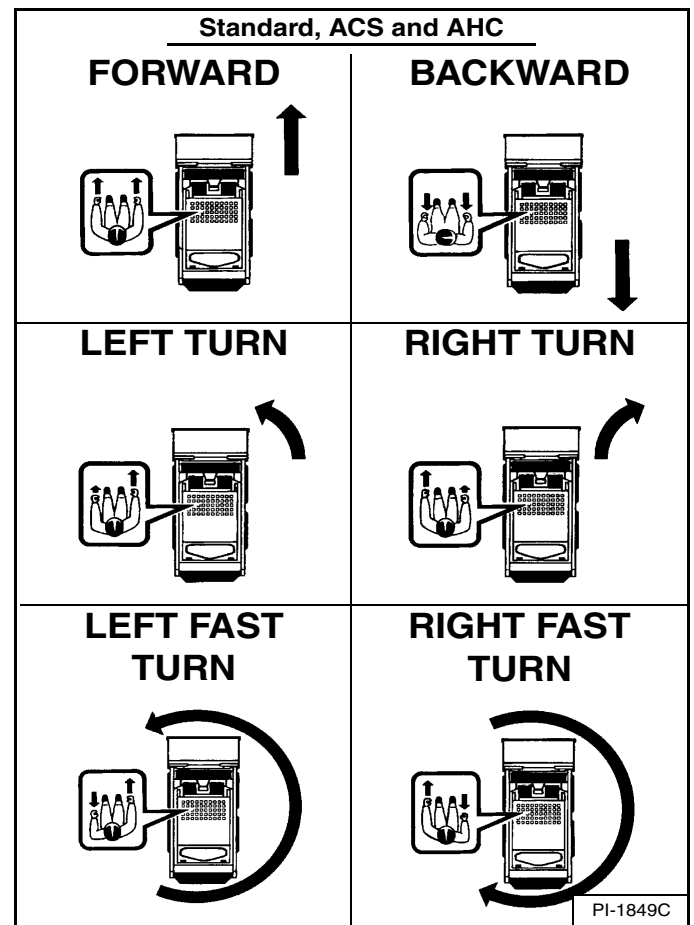

The steering levers control forward and backward travel and turning the loader [Figure 51].

Forward Travel - Push both levers forward.

Backward Travel - Pull both levers backward.

Normal Turning - Move one lever farther forward than the other.

Fast Turning - Push one lever forward and pull the other lever backward.



AVOID INJURY OR DEATH

When operating the machine:

- Keep the seat belt fastened snugly.
- The seat bar must be lowered.
- Keep your feet on the pedal controls or footrests and hands on the controls.

W-2261-0909

DRIVING AND STEERING THE LOADER (CONT'D)

Operation (SJC) In 'ISO' Control Pattern

Figure 52

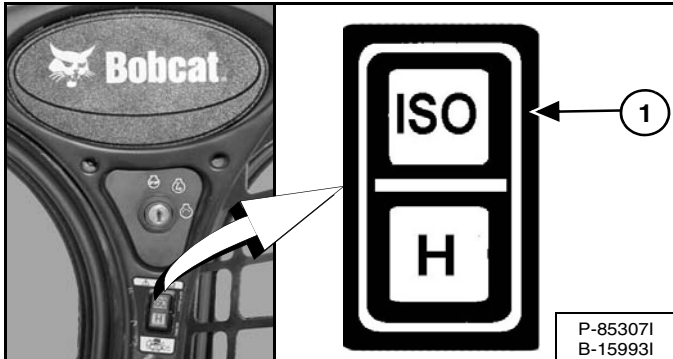

Select the 'ISO' control pattern by pressing the top of the switch (Item 1) [Figure 52].



AVOID INJURY OR DEATH

When operating the machine:

- Keep the seat belt fastened snugly.
- The seat bar must be lowered.
- Keep your feet on the foot rests and hands on control levers.

W-2399-0501

Figure 53



The joystick that controls drive and steering is on the left side in front of the seat (Item 1) [Figure 53].

Move the joystick smoothly. Avoid sudden starting and stopping.

Figure 54

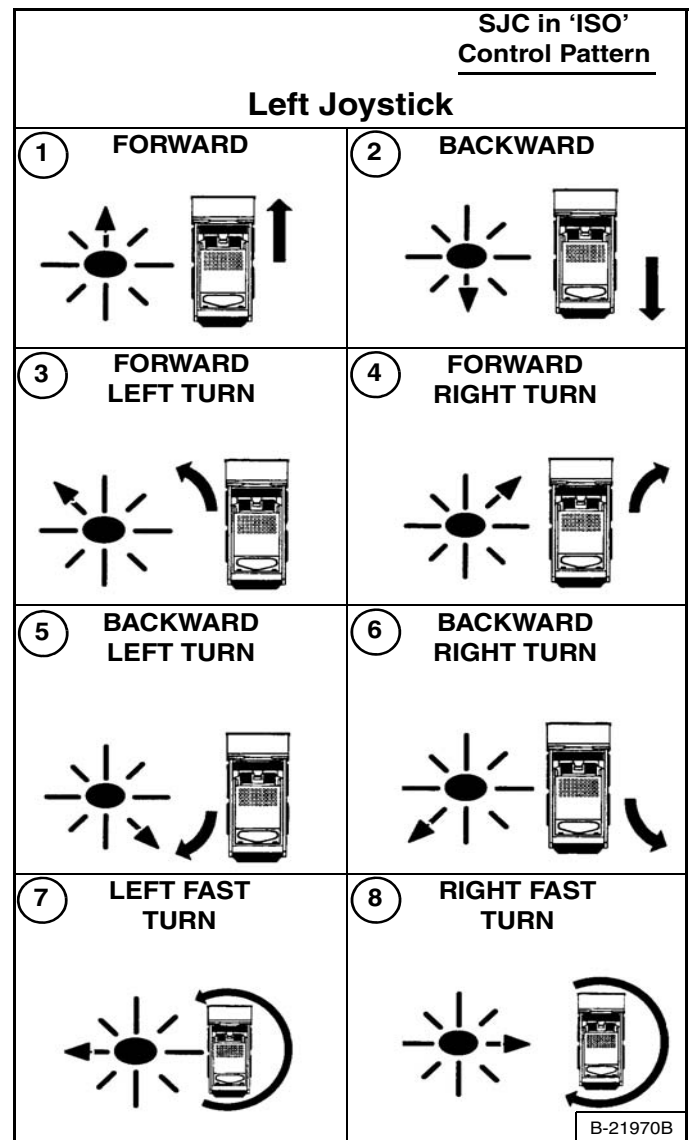

Left Joystick Functions (Drive And Steering) [Figure 54].

1. **Forward Travel** - Move joystick forward.
2. **Backward Travel** - Move joystick backward.
3. **Forward Left Turn** - Move joystick forward and to the left.
4. **Forward Right Turn** - Move joystick forward and to the right.
5. **Backward Left Turn** - Move joystick backward and to the right.
6. **Backward Right Turn** - Move joystick backward and to the left.
7. **Left Fast Turn** - Move joystick to the left.
8. **Right Fast Turn** - Move joystick to the right.

TWO-SPEED CONTROL

Description

This machine may be equipped with two speed ranges, high and low range. High range allows you to reduce cycle times when there is a long travel distance between the dig site and the dump site. You can also use the high range when travelling from one job site to another at faster speeds.



HITTING OBSTRUCTIONS AT HIGH RANGE SPEEDS CAN CAUSE SERIOUS INJURY OR DEATH
Fasten shoulder belt for additional restraint when operating at high range speeds.

W-2754-0908

Figure 58

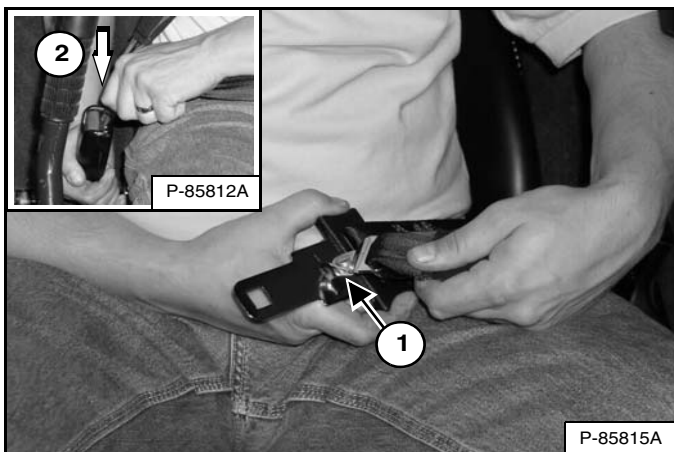

NOTE: The 3-point restraint must be used when selecting high range operation [Figure 58].

Connect the shoulder belt to the lap belt (Item 1) [Figure 58]. Pull the lap belt across to the right side of the seat and fasten (Item 2) [Figure 58].

The shoulder belt must be positioned over your left shoulder and lap belt over your lower hips [Figure 58].

Operation (Standard, ACS And AHC) (If Equipped)

Figure 59

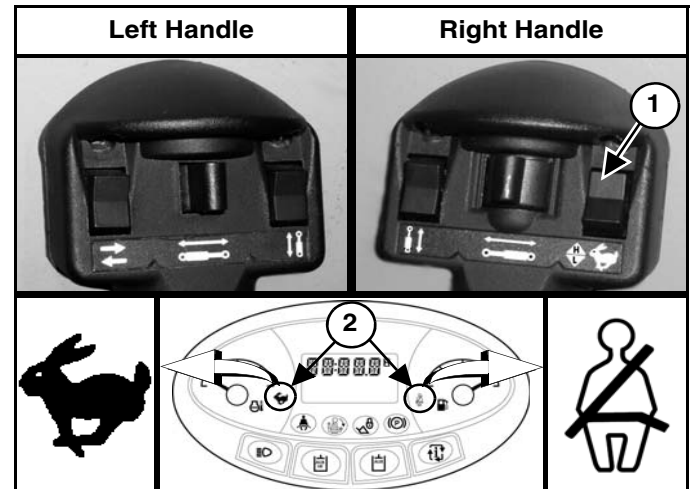

Press the top of the switch (Item 1) on the right handle for high range. The two-speed and shoulder belt icons located on the left instrument panel (Item 2) [Figure 59] will come on.

NOTE: This toggle switch retains the selected range. The loader will be in high range speed at start-up if the switch is in the high range position.

Press the bottom of the switch for low range.

Operation (SJC) (If Equipped)

Figure 60

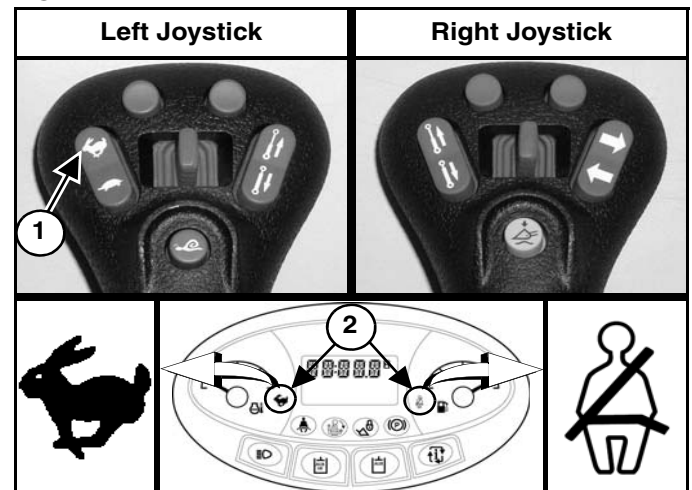

NOTE: You must disengage Speed Management before you can select high range.

Press the top of the switch (Item 1) on the left joystick for high range. The two-speed and shoulder belt icons located on the left instrument panel (Item 2) [Figure 60] will come on.

Press the bottom of the switch for low range.

SPEED MANAGEMENT

Speed Management is available on SJC equipped machines.

Operation

Speed Management allows the loader to be maneuvered at a slower travel speed, even during maximum movement of the joystick(s).

This feature can be useful when installing attachments, loading or unloading, and certain applications. (EXAMPLES: Landscaping, tilling, trenching)

NOTE: Two-Speed Loaders Only - You must be in low range speed to engage Speed Management.

Figure 61

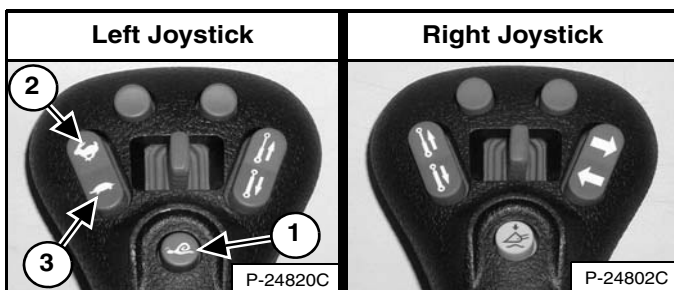

Press the button (Item 1) [Figure 61] on the left joystick once to engage Speed Management.

Figure 62

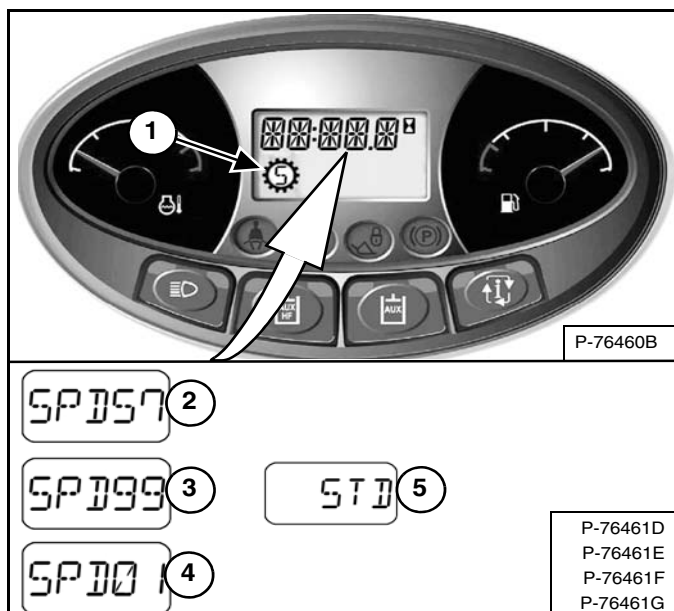

The Speed Management icon (Item 1) [Figure 62] will appear in the display and remain on until the Speed Management button is pressed again or the machine is turned off.

When Speed Management is engaged, the machine will travel at the factory default setting of 57% of Standard Travel Speed and the percentage [SPD 57] will appear in the display (Item 2) [Figure 62].

NOTE: The factory default setting can be changed by the operator. (See Changing The Factory Default Setting on Page 72.)

While Speed Management is engaged, press the top of the Speed Control switch (Item 2) [Figure 61] to increase the speed up to 99% [SPD 99] or the bottom of the switch (Item 3) [Figure 61] to decrease the speed down to 1% [SPD 01]. The percentages will appear in the display (Items 2, 3 and 4) [Figure 62].

Press button (Item 1) [Figure 61] again to disengage Speed Management and return to Standard Travel Speed. [STD] (Item 5) [Figure 62] will appear in the display.

The system will retain the speed percentage as long as the loader remains ON.

EXAMPLE: You can be using the machine at 40% and then disengage Speed Management to reposition the loader, then re-engage Speed Management. The speed percentage will still be at 40%.

EXAMPLE: Turning the key OFF or pressing the STOP button will return the Speed Management setting to default. The next time you start the engine and engage Speed Management, the speed will be at 57% (factory default setting) or the last default setting saved by the operator. (See Changing The Factory Default Setting on Page 72.)

NOTE: Two-Speed Loaders Only - You must disengage Speed Management before you can select high range.

SPEED MANAGEMENT (CONT'D)

Changing The Factory Default Setting

The Speed Management factory default setting can be changed by the operator to save adjustment time.

EXAMPLE: Your machine is often used for trenching and you prefer a Speed Management setting of 28% of Standard Travel Speed for that application. The Speed Management default setting can be changed to 28% of Standard Travel Speed instead of the factory default setting of 57%. Each time you start the machine and first select Speed Management, the machine will default to 28% of Standard Travel Speed.

Engage Speed Management. (See Operation on Page 71.)

Figure 63

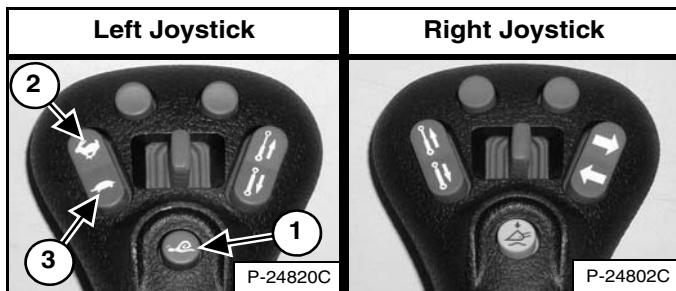

Adjust the speed percentage higher (Item 2) or lower (Item 3) [Figure 63] by pressing the Speed Control switch until the desired default setting is displayed.

Press and hold the button (Item 1) [Figure 63] on the left joystick to save the default setting.

Figure 64

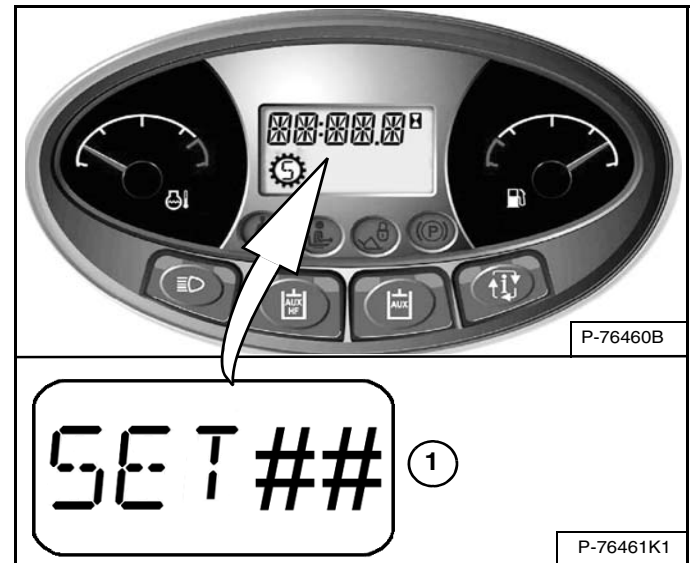

The alarm will beep once, display [SET ##] (## will be the percentage you selected) (Item 1) [Figure 64] and remain in Speed Management mode.

Pressing the button (Item 1) [Figure 63] on the left joystick or turning the machine off will disengage Speed Management and return the loader to Standard Travel Speed.

When Speed Management is first selected each time the machine is started, the percentage you selected will be the default setting. Speed Management can still be adjusted from 1% to 99% of Standard Travel Speed.

The default setting can be changed any time the operator chooses.



DRIVE RESPONSE

Drive Response is available on SJC equipped machines.

Description

Drive Response changes how responsive (more or less) the loaders drive and steering systems are when the operator moves the joystick(s).

Drive Response can be changed by the operator for different drive response preferences and various job conditions and attachment use.

NOTE: Changes to drive response do not affect braking or stopping the loader.

There are three drive response settings:

- **[DR-1]** provides a smooth responsive reaction to joystick movement. (Drive only)
- **[DR-2]** is the default setting and provides a normal responsive reaction to joystick movement. (Drive only)
- **[DR-3]** provides a quick responsive reaction to joystick movement. (Drive only)

Operation

NOTE: Changes CANNOT be performed until the seat bar is lowered, the engine is started and the PRESS TO OPERATE LOADER button is pressed to activate the BICS™.

Perform pre-starting and starting procedures:

1. Fasten seat belt.
2. Lower seat bar.
3. Place joysticks in neutral position.
4. Start the engine.
5. Press the PRESS TO OPERATE LOADER button.
6. Current drive response setting will be displayed briefly in the data display.

NOTE: Raising the seat bar or changing control mode (ISO / H) will cause the machine to disengage from drive response. The last displayed setting will remain in effect until the machine is turned OFF.

DRIVE RESPONSE (CONT'D)

Operation (Cont'd)

Figure 65

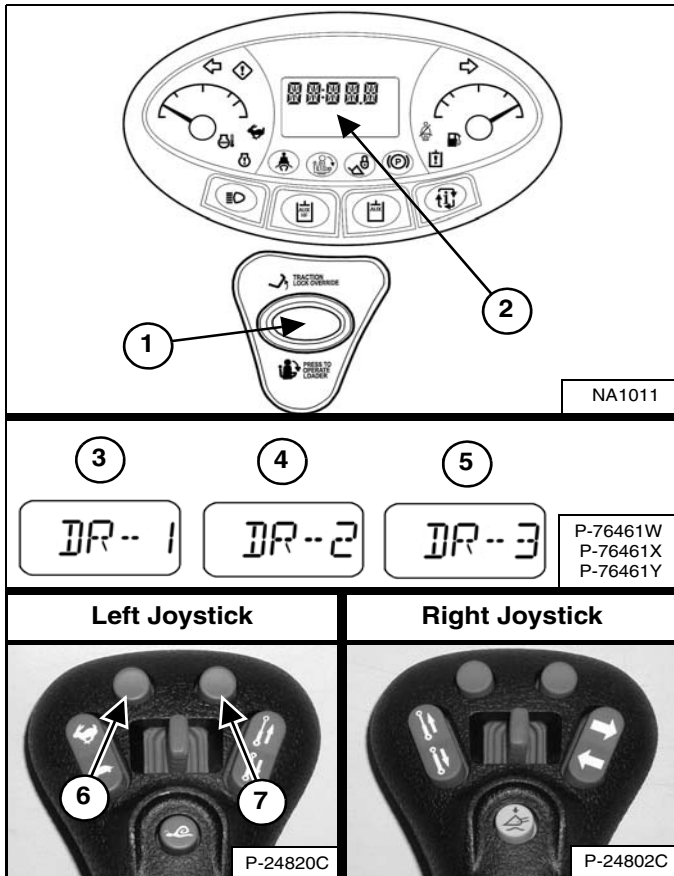

Press and hold the PRESS TO OPERATE LOADER button (Item 1) for **three seconds** to adjust the loaders drive response setting. The current drive response setting will appear in the data display (Item 2) [Figure 65].

Press the upper left or upper right button on the left joystick to adjust the setting. Adjustments to the drive response will be effective immediately. Press the upper left button (Item 6) on the left joystick to scroll down through the three drive response settings (Items 3, 4 and 5). Press the upper right button (Item 7) on the left joystick to scroll up through the three drive response settings (Items 3, 4 and 5) [Figure 65].

Figure 66

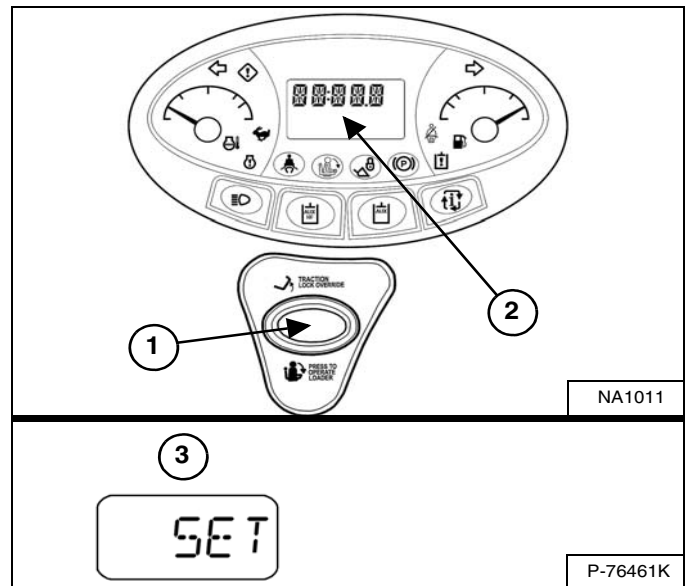

Saving The Drive Response Setting:

The current drive response setting can be saved by pressing and holding the PRESS TO OPERATE LOADER button (Item 1) for **three seconds**. [SET] (Item 3) will appear in the data display (Item 2) [Figure 66] and the machine will exit from the drive response adjustment menu.

OR

Press the PRESS TO OPERATE LOADER button to exit from the drive response adjustment menu without saving the current setting.

The current steering drift compensation setting (See STEERING DRIFT COMPENSATION on Page 75.) will appear in the data display (Item 2) [Figure 66] and the upper left and upper right buttons on the left joystick will no longer make changes to drive response.

NOTE: The last displayed drive response setting will remain in effect until the machine is turned OFF. The machine will revert back to the last saved drive response setting the next time it is started.

Adjustments to steering drift compensation can now be made (See STEERING DRIFT COMPENSATION on Page 75.)

OR

Press the PRESS TO OPERATE LOADER button again to exit from the steering drift compensation adjustment menu.

STEERING DRIFT COMPENSATION

Steering Drift Compensation is available on SJC equipped machines.

Description

Steering Drift Compensation can be used to reduce steering drift to maintain a desired travel path in both forward and reverse directions.

Examples of applications where this feature can be used:

- To compensate for normal variations such as tyre inflation pressure, track tension, tyre wear and track wear.
- Using side shift attachments such as trenchers, planers and silt fence installers.
- Driving on uneven terrain such as crowned road surfaces.

Figure 67

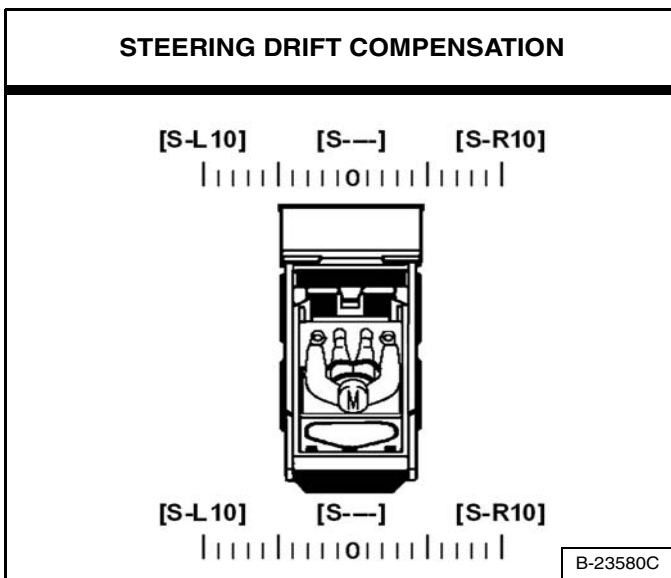

Steering drift compensation contains a total of 21 settings. Steering drift compensation can be set to any point from neutral to [S-L10] left and from neutral to [S-R10] right. [S---] is displayed when set for neutral [Figure 67].

Operation

NOTE: Changes CANNOT be performed until the seat bar is lowered, the engine is started and the PRESS TO OPERATE LOADER button is pressed to activate the BICS™.

Perform pre-starting and starting procedures:

1. Fasten seat belt.
2. Lower seat bar.
3. Place joysticks in neutral position.
4. Start the engine.
5. Press the PRESS TO OPERATE LOADER button.
6. Current drive response setting will be displayed briefly in the data display.

NOTE: Raising the seat bar or changing control mode (ISO / H) will cause the machine to disengage from steering drift compensation. The last displayed setting will remain in effect until the machine is turned OFF.

STEERING DRIFT COMPENSATION (CONT'D)

Operation (Cont'd)

Figure 68

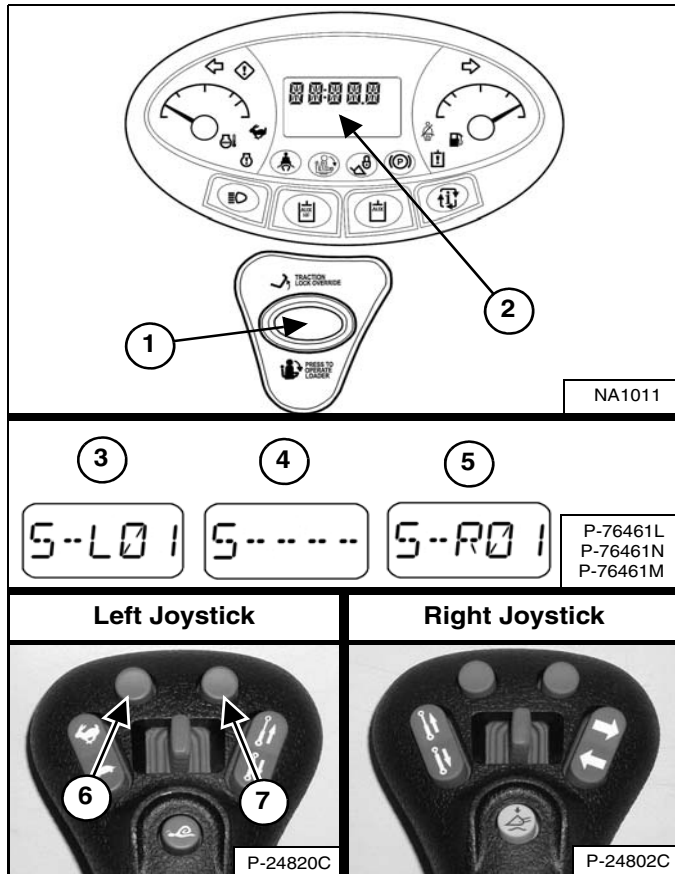

Press and hold the PRESS TO OPERATE LOADER button (Item 1) for **three seconds** to access the drive response adjustment menu. Press the PRESS TO OPERATE LOADER button (Item 1) again to adjust the loaders steering drift compensation setting. The current steering drift compensation setting will appear in the data display (Item 2) [Figure 68].

Press the upper left button (Item 6) on the left joystick to adjust the machine left. [S-L01] (Item 3) through a maximum of [S-L10] will appear in the data display (Item 2) [Figure 68]. The number will increase by one each time you press the button. The higher the number, the greater the amount of steering drift compensation to the left. Adjustments to steering drift compensation will be effective immediately.

Press the upper right button (Item 7) on the left joystick to adjust back toward centre. The display will decrease down to neutral displayed as [S----] (Item 4). Another press of the upper right button will cause [S-R01] (Item 5) to appear in the data display (Item 2) [Figure 68]. The number will increase by one each time you press the button up to a maximum of [S-R10]. The higher the number, the greater the amount of steering drift compensation to the right. Adjustments to steering drift compensation will be effective immediately.

Figure 69

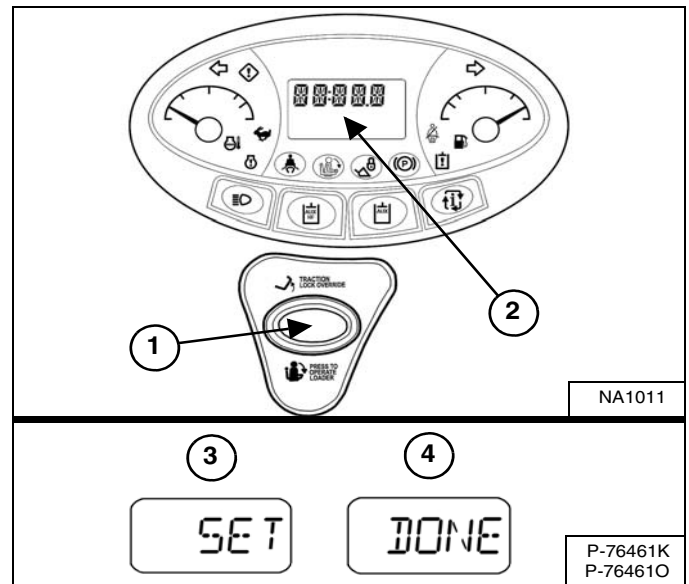

Saving The Steering Drift Compensation Setting:

The current steering drift compensation setting can be saved by pressing and holding the PRESS TO OPERATE LOADER button (Item 1) for **three seconds**. [SET] (Item 3) will appear in the data display (Item 2) [Figure 69] and the machine will exit from the steering drift compensation adjustment menu.

OR

Press the PRESS TO OPERATE LOADER button to exit from the steering drift compensation adjustment menu without saving the current setting. [DONE] (Item 4) will appear in the data display (Item 2) [Figure 69] and the upper left and upper right buttons on the left joystick will no longer make changes to steering drift compensation.

NOTE: The last displayed steering drift compensation setting will remain in effect until the machine is turned OFF. The machine will revert back to the last saved setting the next time it is started.

HYDRAULIC CONTROLS

Description

Two foot pedals (or optional hand controls or optional joysticks) control the hydraulic cylinders for the lift and tilt functions.

Put your feet on the pedals (or footrests) and KEEP THEM THERE any time you operate the loader.

Standard Controls (Also ACS In FOOT Pedal Mode)

Figure 70

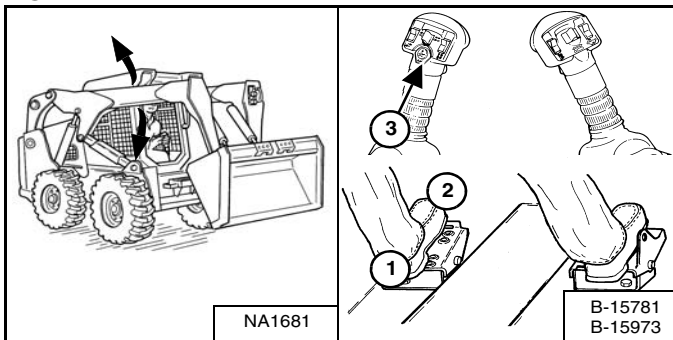

Lift Arm Operation - (Left Pedal)

Push the heel (Item 1) [Figure 70] of the pedal to raise the lift arms.

Push the toe (Item 2) [Figure 70] of the pedal to lower the lift arms.

Lift Arm Float Position - (Left Pedal)

Push the toe (Item 2) [Figure 70] of the pedal all the way forward until it locks into the float position.

Use the float position of the lift arms to level loose material while driving backward.

Raise the lift arms to disengage the float position.

Lift Arm Float Position (With ACS) - (Left Pedal And Left Handle)

Press and hold the Float button (Item 3) [Figure 70].

Push the toe (Item 2) [Figure 70] of the pedal forward to lower the lift arms. Then release the float button.

Use the float position of the lift arms to level loose material while driving backward.

Raise the lift arms to disengage the float position.

Figure 71

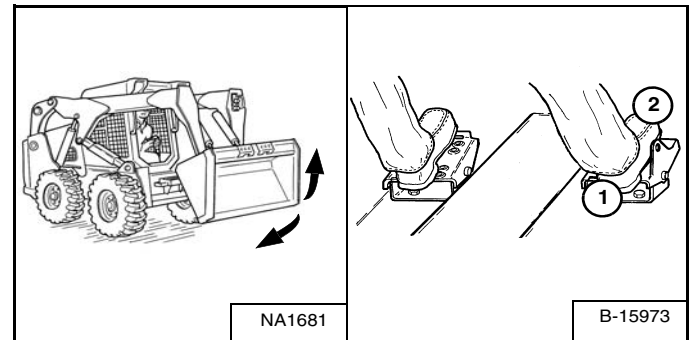

Tilt Operation - (Right Pedal)

Push the heel (Item 1) [Figure 71] of the pedal to tilt the bucket backward.

Push the toe (Item 2) [Figure 71] of the pedal to tilt the bucket forward.

HYDRAULIC CONTROLS (CONT'D)

Advanced Control System (ACS) In HAND Control Mode And Advanced Hand Controls (AHC)

Figure 72

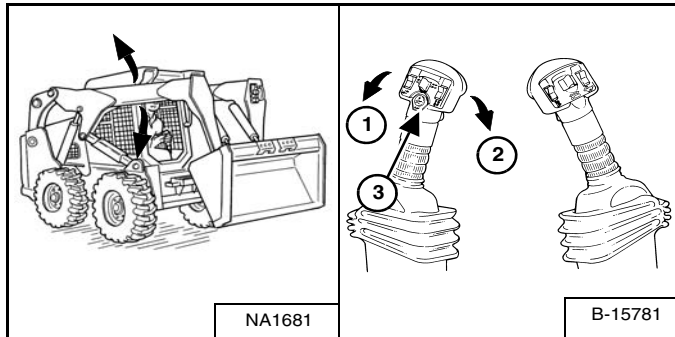

Lift Arm Operation - (Left Hand Lever)

Move the lever outward (Item 1) [Figure 72] to raise the lift arms.

Move the lever inward (Item 2) [Figure 72] to lower the lift arms.

Lift Arm Float Position - (Left Hand Lever)

Press and hold the Float button (Item 3) [Figure 72] while the lever is in neutral. Move the lever to lift arm down position (Item 2) [Figure 72], then release the button.

Press Float button (Item 3) [Figure 72] again or move the lever to lift arm up position to disengage.

Use the float position of the lift arms to level loose material while driving backward.

Figure 73

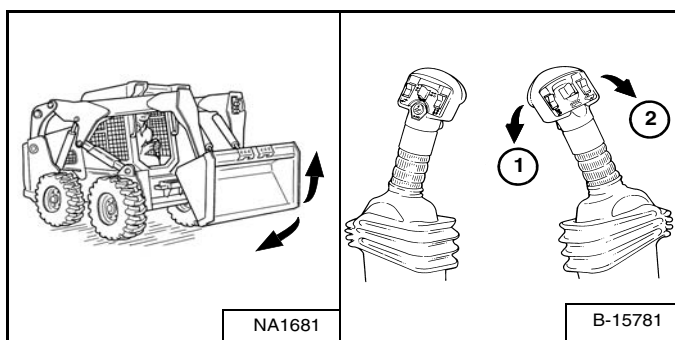

Tilt Operation - (Right Hand Lever)

Move the lever inward (Item 1) [Figure 73] to tilt the bucket backward.

Move the lever outward (Item 2) [Figure 73] to tilt the bucket forward.

Selectable Joystick Controls (SJC) In 'ISO' Control Pattern

Figure 74

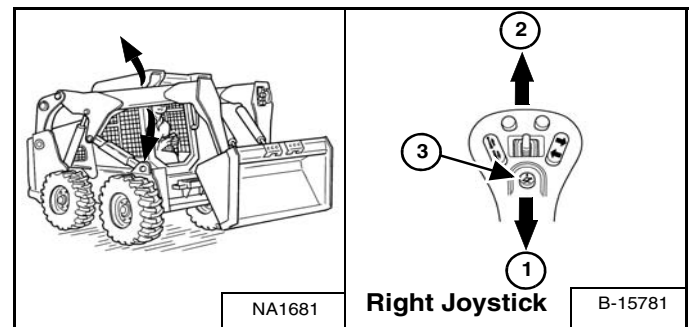

Lift Arm Operation - (Right Hand Joystick)

Move the joystick backward (Item 1) [Figure 74] to raise the lift arms.

Move the joystick forward (Item 2) [Figure 74] to lower the lift arms.

Lift Arm Float Position - (Right Hand Joystick)

Press and hold the Float button (Item 3) [Figure 74] while the joystick is in neutral. Move the joystick to lift arm down position (Item 2) [Figure 74], then release the button.

Press Float button (Item 3) again or move the joystick to lift arm up position (Item 1) [Figure 74] to disengage.

Use the float position of the lift arms to level loose material while driving backward.

Figure 75

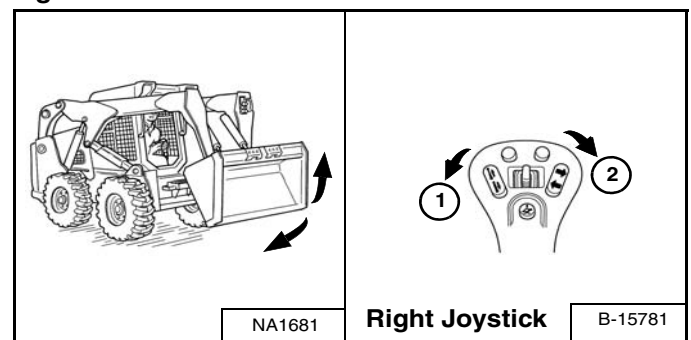

Tilt Operation - (Right Hand Joystick)

Move the joystick inward (Item 1) [Figure 75] to tilt the bucket backward.

Move the joystick outward (Item 2) [Figure 75] to tilt the bucket forward.

HYDRAULIC CONTROLS (CONT'D)

Selectable Joystick Controls (SJC) In 'H' Control Pattern

Figure 76

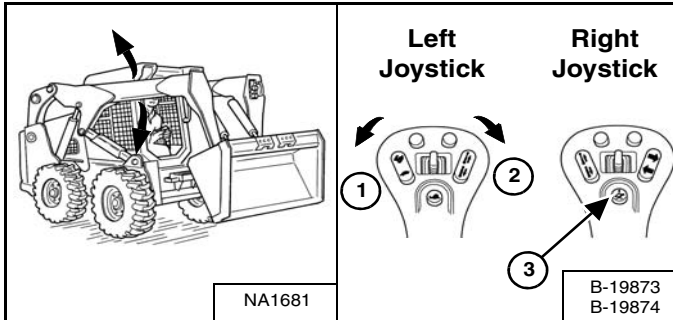

Lift Arm Operation - (Left Hand Joystick)

Move the joystick outward (Item 1) [Figure 76] to raise the lift arms.

Move the joystick inward (Item 2) [Figure 76] to lower the lift arms.

Lift Arm Float Position - (Left And Right Hand Joysticks)

Press and hold the Float button (Item 3) [Figure 76] while the joysticks are in neutral. Move the left joystick to lift arm down position (Item 2) [Figure 76], then release the button.

Press Float button (Item 3) [Figure 76] again or move the left joystick to lift arm up position to disengage.

Use the float position of the lift arms to level loose material while driving backward.

Figure 77

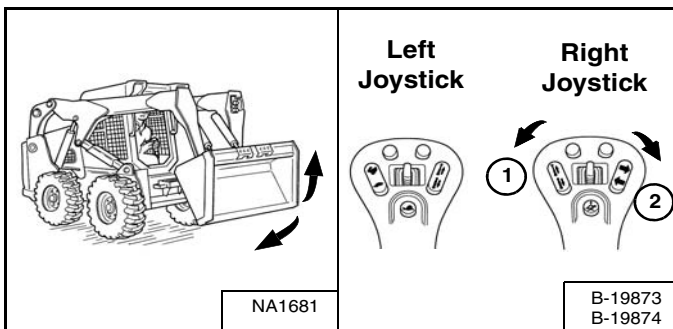

Tilt Operation - (Right Hand Joystick)

Move the joystick inward (Item 1) [Figure 77] to tilt the bucket backward.

Move the joystick outward (Item 2) [Figure 77] to tilt the bucket forward.

Hydraulic Bucket Positioning

This machine may be equipped with Hydraulic Bucket Positioning.

The function of hydraulic bucket positioning is to keep the bucket at the same approximate angle as the lift arms are raised.

Figure 78

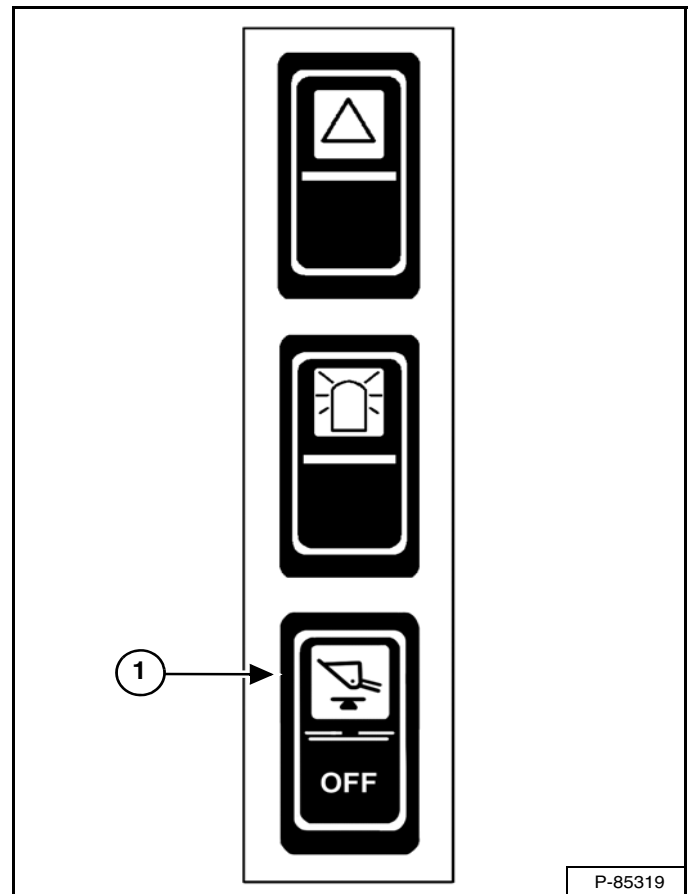

Press the top of the BUCKET POSITIONING switch (Item 1) [Figure 78] on the left switch panel to engage the bucket positioning function. The amber light in the switch will turn on. Press the bottom of the switch to disengage. The amber light will turn off.

Bucket positioning functions only during upward lift cycle.

HYDRAULIC CONTROLS (CONT'D)

FRONT Auxiliary Hydraulics Operation

Figure 79



Press the auxiliary hydraulics button (Item 1) [Figure 79] once to activate the auxiliary hydraulics.

The light (Item 2) [Figure 79] will be ON.

Standard, ACS And AHC (If Equipped)

Figure 80

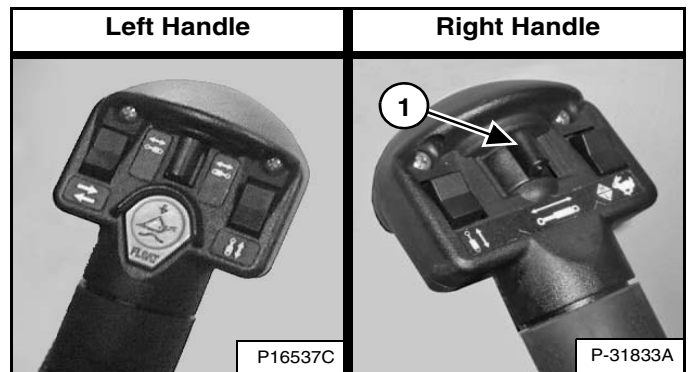

SJC (If Equipped)

Figure 81

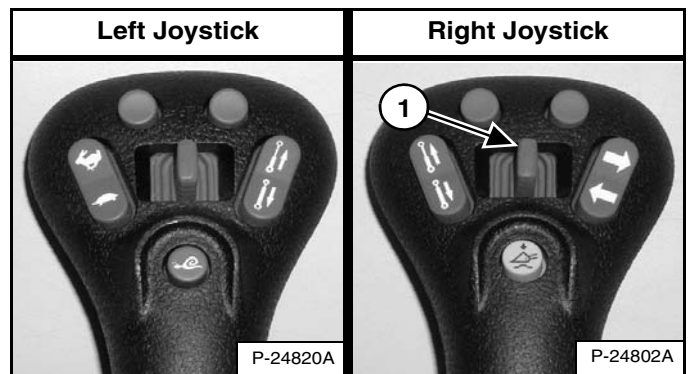

Move the front auxiliary hydraulic switch (Item 1) [Figure 80] or [Figure 81] to the right or left to change direction of the auxiliary hydraulic oil flow to the front quick couplers. If you move the switch half-way, the auxiliary functions move at approximately one-half speed. (EXAMPLE: Open and close grapple teeth.)

Release the front auxiliary hydraulic switch to stop hydraulic oil flow to the front quick couplers.

To deactivate the auxiliary hydraulics, press the auxiliary hydraulics button (Item 1) [Figure 79] again.

The light (Item 2) [Figure 79] will be OFF.

NOTE: When the operator is seated and raises the seat bar, the Auxiliary Hydraulic System (Front and Rear) will deactivate.

HYDRAULIC CONTROLS (CONT'D)

FRONT Auxiliary Hydraulics Operation (CONTINUOUS FLOW)

Standard, ACS And AHC (If Equipped)

Figure 82

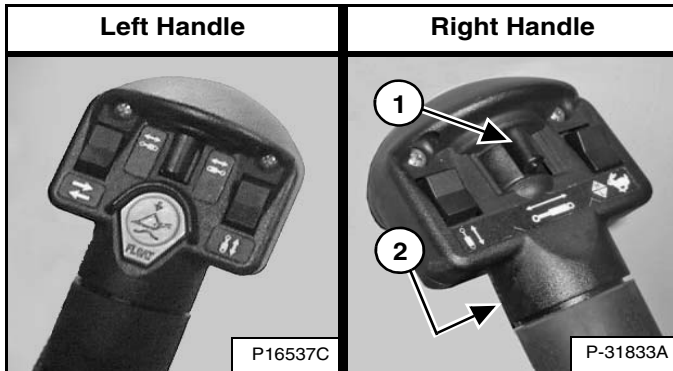

SJC (If Equipped)

Figure 83

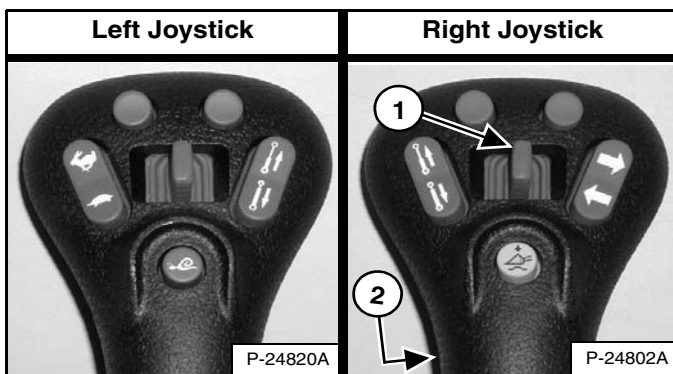

After activating the auxiliary hydraulics, press the continuous flow control switch (Item 2) [Figure 82] or [Figure 83] to allow constant auxiliary hydraulic oil flow to the front female coupler (female coupler is pressurised). (EXAMPLE: Operate a backhoe.)

To stop continuous auxiliary hydraulic oil flow, press the front auxiliary hydraulic switch (Item 2) [Figure 82] or [Figure 83] a second time.

NOTE: When the operator is seated and raises the seat bar, the Auxiliary Hydraulic System (Front and Rear) will deactivate.

FRONT Auxiliary Hydraulics Operation (REVERSE CONTINUOUS FLOW)

To allow constant auxiliary hydraulic oil flow to the front male coupler (male coupler is pressurised):

1. Activate the auxiliary hydraulics.
2. Move the front auxiliary hydraulic switch (Item 1) [Figure 82] or [Figure 83] to the left and hold it there.
3. Press the continuous flow control switch (Item 2) [Figure 82] or [Figure 83].
4. Release the front auxiliary hydraulic switch.

NOTE: Reverse flow can cause damage to some attachments. Use reverse flow with your attachment only if approved. See your attachment Operation & Maintenance Manual for detailed information.

To stop reverse continuous auxiliary hydraulic oil flow, press the front auxiliary hydraulic switch (Item 2) [Figure 82] or [Figure 83] a second time.

NOTE: When the operator is seated and raises the seat bar, the Auxiliary Hydraulic System (Front and Rear) will deactivate.

HYDRAULIC CONTROLS (CONT'D)

REAR Auxiliary Hydraulics Operation

This machine may be equipped with Rear Auxiliary Hydraulics.

Figure 84



The switches on the left hand lever or joystick control the rear auxiliary hydraulics.

Figure 85



Press the auxiliary hydraulics button (Item 1) [Figure 85] once to activate the auxiliary hydraulics.

The light (Item 2) [Figure 85] will be ON.

Standard, ACS And AHC (If Equipped)

Figure 86



SJC (If Equipped)

Figure 87

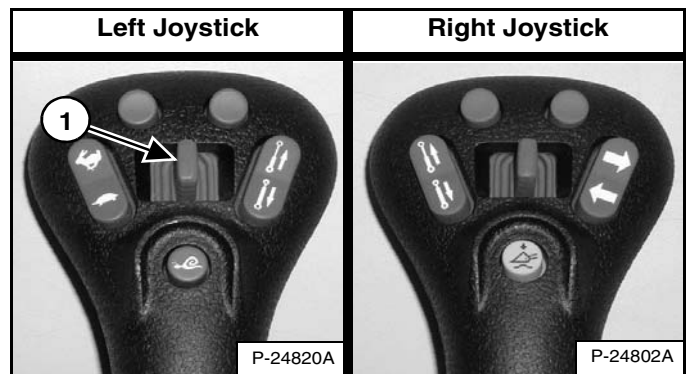

Push the rear auxiliary hydraulic switch (Item 1) [Figure 86] or [Figure 87] to the right or left to change direction of the auxiliary hydraulic oil flow to the rear quick couplers [Figure 84]. (EXAMPLE: Raise and lower rear stabilisers.)

To deactivate the auxiliary hydraulics, press the auxiliary hydraulics button (Item 1) [Figure 85] again.

The light (Item 2) [Figure 85] will be OFF.

NOTE: When the operator is seated and raises the seat bar, the Auxiliary Hydraulic System (Front and Rear) will deactivate.

HYDRAULIC CONTROLS (CONT'D)

High-Flow Hydraulics Operation

This machine may be equipped with High-Flow Hydraulics.

Figure 88

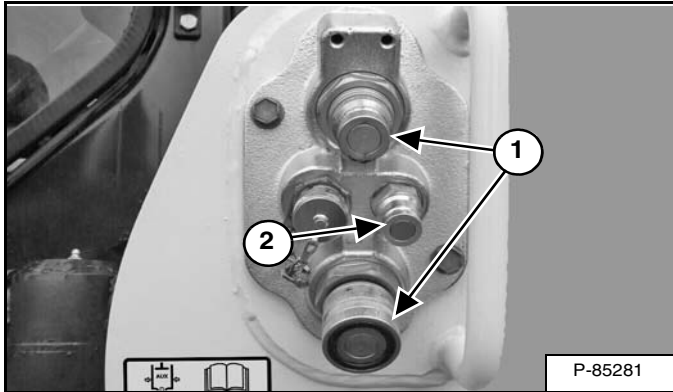

The High-Flow function provides additional hydraulic oil flow to the system to operate an attachment which requires more hydraulic flow. (EXAMPLE: High-Flow Planer)

Connect the attachment to the front quick couplers (Item 1) [Figure 88].

Some attachments may have a case drain which needs to be connected to the small quick coupler (Item 2) [Figure 88].

Activate the auxiliary hydraulics.

Figure 89



Press the HIGH FLOW button (Item 1) [Figure 89] to activate high flow auxiliary hydraulics operation.

The light (Item 2) [Figure 89] will be ON.

To deactivate the high flow auxiliary hydraulics operation, press the HIGH FLOW button (Item 1) [Figure 89] again.

The light (Item 2) [Figure 89] will be OFF.

Quick Couplers



AVOID INJURY OR DEATH

Diesel fuel or hydraulic fluid under pressure can penetrate skin or eyes, causing serious injury or death. Fluid leaks under pressure may not be visible. Use a piece of cardboard or wood to find leaks. Do not use your bare hand. Wear safety goggles. If fluid enters skin or eyes, get immediate medical attention from a doctor familiar with this injury.

W-2072-EN-0909

Figure 90

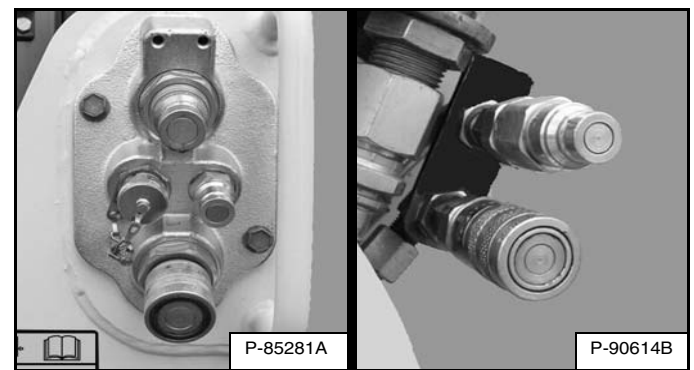

To Connect: Remove dirt or debris from the surface of both the male and female couplers, and from the outside diameter of the male couplers. Visually check the couplers for corroding, cracking, damage or excessive wear. If any of these conditions exist, the coupler(s) [Figure 90] must be replaced.

Install the male couplers into the female couplers. Full connection is made when the ball release sleeves slide forward on the female couplers.

To Disconnect: Hold the male couplers. Retract the sleeves on the female couplers until the couplers disconnect.



AVOID BURNS

Hydraulic fluid, tubes, fittings and quick couplers can get hot when running machine and attachments. Be careful when connecting and disconnecting quick couplers.

W-2220-0396

HYDRAULIC CONTROLS (CONT'D)

Relieve Auxiliary Hydraulic Pressure (Loader And Attachment)



AVOID BURNS

Hydraulic fluid, tubes, fittings and quick couplers can get hot when running machine and attachments. Be careful when connecting and disconnecting quick couplers.

W-2220-0396



AVOID INJURY OR DEATH

Diesel fuel or hydraulic fluid under pressure can penetrate skin or eyes, causing serious injury or death. Fluid leaks under pressure may not be visible. Use a piece of cardboard or wood to find leaks. Do not use your bare hand. Wear safety goggles. If fluid enters skin or eyes, get immediate medical attention from a doctor familiar with this injury.

W-2072-EN-0909

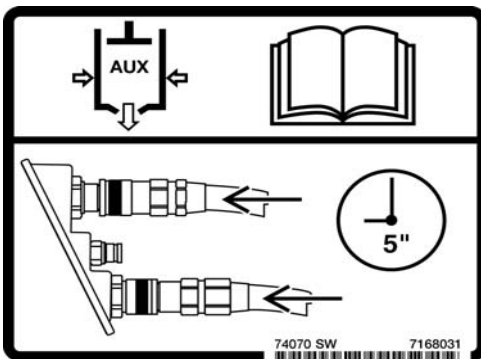

Front Auxiliary Quick Couplers

When Connecting: Push the quick couplers tightly together and hold for five seconds; the pressure is automatically relieved as the couplers are installed.

When Disconnecting: Push the quick couplers tightly together and hold for five seconds; then retract the sleeves until the couplers disconnect.

Rear Auxiliary Quick Couplers

Put the attachment flat on the ground.

Stop the engine and turn the key to RUN or press the RUN button.

Figure 91



Press the auxiliary hydraulics button (Item 1) [Figure 91].

Standard, ACS And AHC (If Equipped)

Figure 92

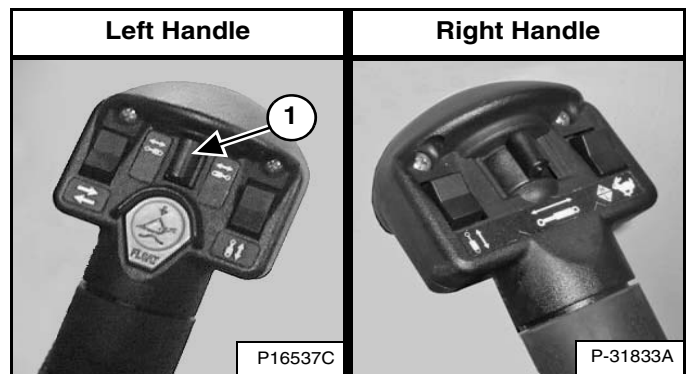

SJC (If Equipped)

Figure 93

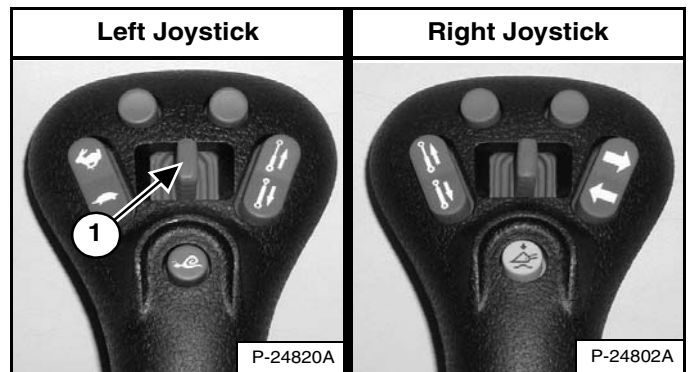

Move the rear auxiliary hydraulic switch (Item 1) [Figure 92] or [Figure 93] to the right and left several times.

ATTACHMENT CONTROL DEVICE (ACD)

This machine may be equipped with an Attachment Control Device.

Description

Figure 94

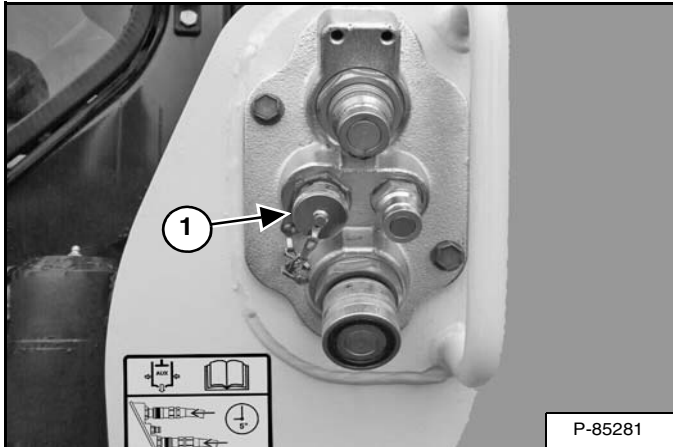

Connect the attachments electrical harness to the attachment control device (Item 1) [Figure 94].

Figure 95

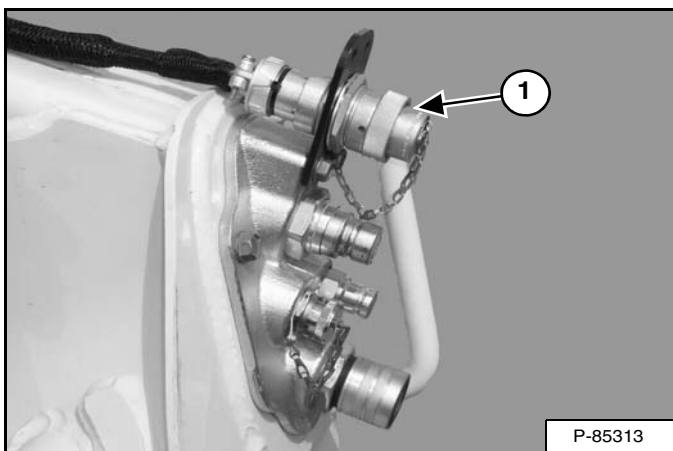

You will need the 14-Pin Attachment Control Device kit (Item 1) [Figure 95] to operate early model attachments. See your Bobcat loader dealer.

Standard, ACS And AHC (If Equipped)

Figure 96

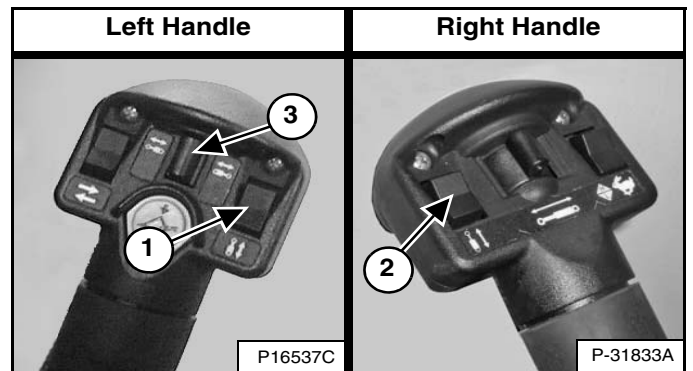

SJC (If Equipped)

Figure 97

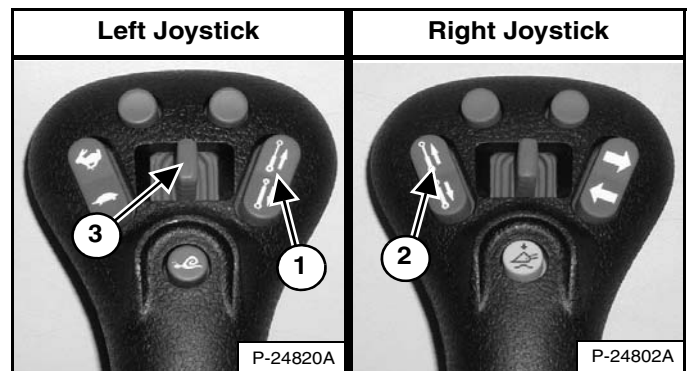

Additional switches (Items 1, 2 and 3) [Figure 96] or [Figure 97] on the right and left control handles or joysticks are used to control some attachment functions through the attachment control device.

NOTE: ACD takes over the function of auxiliary hydraulic switch (Item 3) [Figure 96] or [Figure 97] from Rear Auxiliary Hydraulics when an attachment electrical harness is attached to the ACD.

See the appropriate attachment Operation & Maintenance Manual for control details.

DAILY INSPECTION

Daily Inspection And Maintenance

Maintenance work must be done at regular intervals. Failure to do so will result in excessive wear and early failures. The Service Checklist And Schedule is a guide for correct maintenance of the Bobcat loader.

Figure 98



The Service Checklist And Schedule (Item 1) [Figure 98] is located inside the rear door of the loader.

A chart format of the Service Checklist And Schedule is also available in the Preventive Maintenance section of this manual. (See SERVICE SCHEDULE on Page 131.)

! WARNING

AVOID INJURY OR DEATH

- Keep door / cover closed except for service.
- Keep engine clean of flammable material.
- Keep body, loose objects and clothing away from electrical contacts, moving parts, hot parts and exhaust.
- Do not use the machine in space with explosive dusts or gases or with flammable material near exhaust.
- Never use ether or starting fluid on diesel engine with glow plugs or air intake heater. Use only starting aids as approved by engine manufacturer.
- Leaking fluids under pressure can enter skin and cause serious injury.
- Battery acid causes severe burns; wear goggles. If acid contacts eyes, skin, or clothing, flush with water. For contact with eyes, flush and get medical attention.
- Battery makes flammable and explosive gas. Keep arcs, sparks, flames and lighted tobacco away.
- For jump start, connect negative cable to the machine engine last (never at the battery). After jump start, remove negative connection at the engine first.
- Exhaust gases can kill. Always ventilate.

W-2782-0409

NOTE: Fluids such as engine oil, hydraulic fluid, coolant, etc. must be disposed of in an environmentally safe manner. Some regulations require that certain spills and leaks on the ground must be cleaned in a specific manner. See local bylaws for correct disposal.

! WARNING

Operator must have instructions before operating the machine. Untrained operators can cause injury or death.

W-2001-0502



DAILY INSPECTION (CONT'D)

Daily Inspection And Maintenance (Cont'd)

The following list of items must be checked daily:

- Engine Oil Level
- Hydraulic Fluid Level
- Engine Air Filter - Check System for Damage or Leaks
- Engine Cooling System - Check System for Damage or Leaks, Check Coolant Level, Clean Oil Cooler, Radiator and Rear Grille
- Operator Cab and Cab Mounting Hardware
- Seat Belt
- Seat Bar and Control Interlocks
- Bobcat Interlock Control System (BICS™)
- Front Horn - Check for Proper Function
- Grease Pivot Pins (Lift Arms, Lift Links, Bob-Tach, Cylinders, Bob-Tach Wedges)
- Tyres - Check for Wear, Damage, Correct Air Pressure
- Fuel Filter - Remove Trapped Water
- Loose or Broken Parts - Repair or Replace as Necessary
- Safety Treads and Safety Signs (Decals) - Replace as necessary
- Lift Arm Support Device - Replace if Damaged

IMPORTANT

This machine is factory equipped with a spark arrester exhaust system.

The spark arrester muffler, if equipped, must be cleaned to keep it in working condition. The spark arrester muffler must be serviced by dumping the spark chamber every 100 hours of operation.

On some models, the turbocharger functions as the spark arrester and must operate correctly for proper spark arrester function.

If this machine is operated on flammable forest, brush, or grass covered land, a spark arrester attached to the exhaust system may be required and must be maintained in working order. Refer to local laws and regulations for spark arrester requirements.

I-2284-EN-0909

IMPORTANT

PRESSURE WASHING DECALS

- **Never direct the stream at a low angle toward the decal that could damage the decal causing it to peel from the surface.**
- **Direct the stream at a 90 degree angle and at least 300 mm (12 in) from the decal. Wash from the centre of the decal toward the edges.**

I-2226-EN-0910

PRE-STARTING PROCEDURE

Entering The Loader

Figure 99



Use the bucket or attachment steps, grab handles and safety treads (on the loader lift arms and frame) to get on and off the loader [Figure 99]. Do not jump.

Safety treads are installed on the Bobcat loader to provide a slip resistant surface for getting on and off the loader.

Keep safety treads clean and replace when damaged. Replacement treads are available from your Bobcat dealer.

Operation & Maintenance Manual And Operator's Handbook Locations

Figure 100

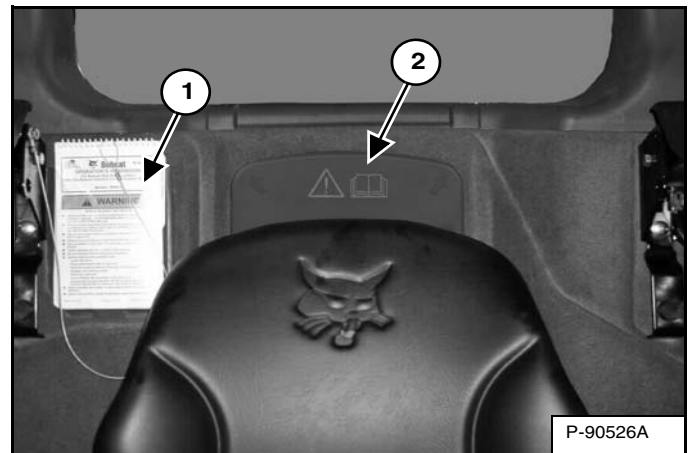

Read and understand the Operation & Maintenance Manual and the Operator's Handbook (Item 1) [Figure 100] before operating the loader.

The Operation & Maintenance Manual and other manuals can be kept in a container (Item 2) [Figure 100] provided behind the operator seat.

WARNING

AVOID INJURY OR DEATH

Instructions are necessary before operating or servicing machine. Read and understand the Operation & Maintenance Manual, Operator's Handbook and signs (decals) on machine. Follow warnings and instructions in the manuals when making repairs, adjustments or servicing. Check for correct function after adjustments, repairs or service. Untrained operators and failure to follow instructions can cause injury or death.

W-2003-0807

PRE-STARTING PROCEDURE (CONT'D)

Seat Adjustment

Suspension Seat

Figure 101



Pull the lever (Item 1) [Figure 101] up to adjust the angle of the seat back.

Pull the lever (Item 2) [Figure 101] up to adjust the seat position for comfortable operation of the loader controls.

Figure 102

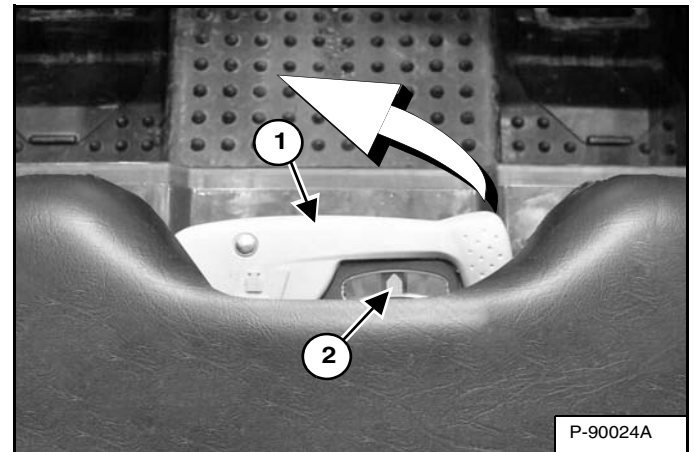

The lever (Item 1) is used to adjust the suspension response of the seat depending on the operator's weight. The optimum setting is achieved with the needle (Item 2) [Figure 102] centred in the gauge with the operator normally seated.

Pivot the lever out fully to adjust the setting. Pump lever between middle and upper positions to move the needle to the right. Pump lever between middle and lower positions to move the needle to the left. Return lever to the middle position and pivot lever back fully to lock in setting.

PRE-STARTING PROCEDURE (CONT'D)

Seat Adjustment (Cont'd)

Air Ride Suspension Seat (Option)

Figure 103

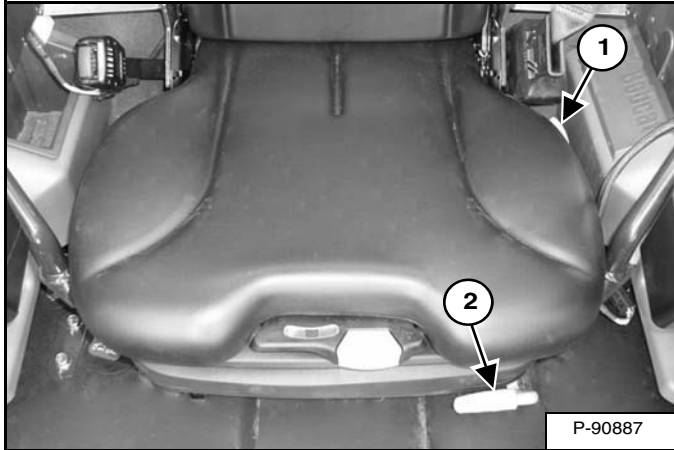

Pull the lever (Item 1) [Figure 103] up to adjust the angle of the seat back.

Pull the lever (Item 2) [Figure 103] up to adjust the seat position for comfortable operation of the loader controls.

Figure 104

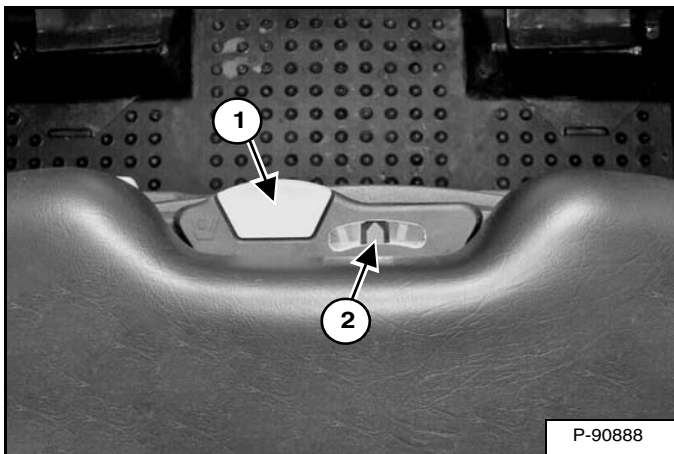

The lever (Item 1) is used to adjust the suspension response of the seat depending on the operator's weight. The optimum setting is achieved with the needle (Item 2) [Figure 104] centred in the gauge with the operator normally seated.

Pull the lever (Item 1) [Figure 104] up and hold to increase the amount of air in the seat suspension. Push the lever down and hold to decrease the amount of air in the seat suspension.

NOTE: The loader electrical system must be turned ON to increase the amount of air in the seat suspension.

Joystick Position Adjustment

Figure 105

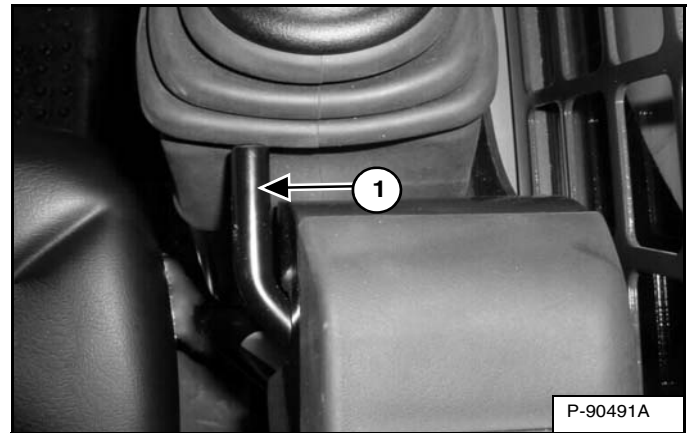

Pull the joystick adjustment levers (Item 1) [Figure 105] up to slide the loader joysticks forward or backward to adjust for comfortable operation. (Right side shown.)

PRE-STARTING PROCEDURE (CONT'D)

Seat Belt Adjustment

Figure 106



Squeeze both seat belt adjusters to release and lengthen each half of the seat belt (Inset) [Figure 106].

Fasten the seat belt.

Pull the ends of the belt through the belt adjusters so that the seat belt is snug and the buckle is centred between your hips [Figure 106].

Figure 107

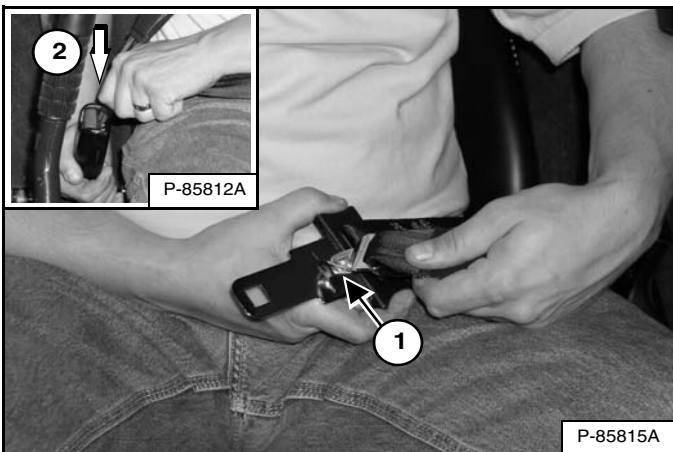

3-Point Restraint - (Option and Loaders with Two-Speed) Connect the shoulder belt to the lap belt (Item 1) [Figure 107]. Pull the lap belt across to the right side of the seat and fasten (Item 2) [Figure 107].

The shoulder belt must be positioned over your left shoulder and lap belt over your lower hips [Figure 107].

IMPORTANT

Check the seat belt and shoulder belt retractors for correct operation.

Keep retractors clean and replace as necessary.

I-2199-0200

Seat Bar

Figure 108



Lower the seat bar and engage the parking brake [Figure 108].

Put the foot pedals or hand controls in neutral position.

NOTE: Keep your hands on the steering levers and your feet on the foot pedals (or footrests) while operating the loader.

! WARNING

AVOID INJURY OR DEATH

When operating the machine:

- Keep the seat belt fastened snugly.
- The seat bar must be lowered.
- Keep your feet on the pedal controls or footrests and hands on the controls.

W-2261-0909

STARTING THE ENGINE

Standard Key Panel

! WARNING

AVOID INJURY OR DEATH

- Engines can have hot parts and hot exhaust gas. Keep flammable material away.
- Do not use machines in atmosphere containing explosive gas.

W-2051-1086

Perform the PRE-STARTING PROCEDURE. (See PRE-STARTING PROCEDURE on Page 88.)

Figure 109

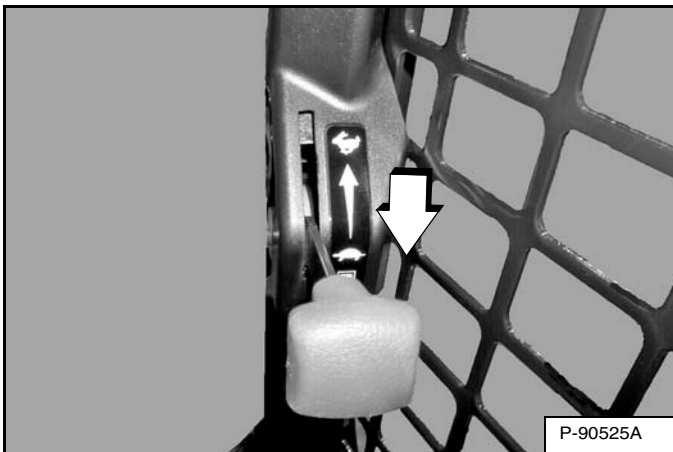

Set the engine speed control to the idle position [Figure 109].

Figure 110

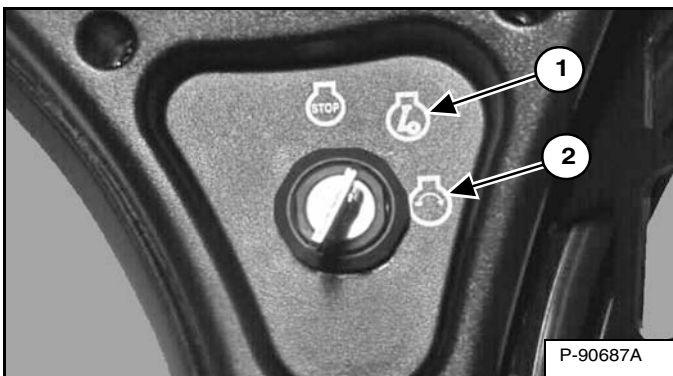

Turn the key switch to RUN (Item 1) [Figure 110]. The indicator lights on the left instrument panel will come ON briefly and the Instrument Panel / monitoring system will do a self test.

Figure 111

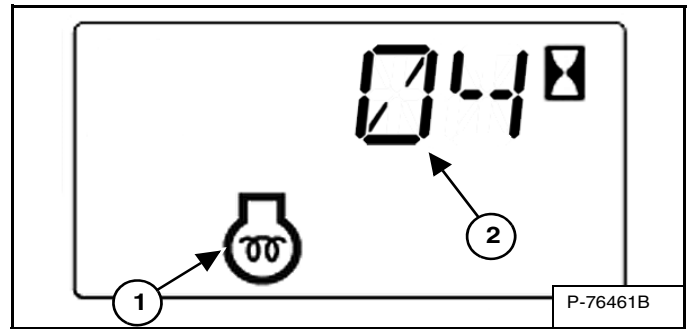

The machine will cycle the air intake heater (glow plugs) automatically based on temperature. The engine preheat icon (Item 1) will be ON and the cycle time remaining will show in the data display (Item 2) [Figure 111].

When the engine preheat icon goes OFF, turn the key switch to START (Item 2). Release the key when the engine starts and allow it to return to the RUN position (Item 1) [Figure 110].

NOTE: Make sure both hand controls (ACS / AHC) or joysticks (SJC) are in the neutral position before starting the engine. Do not move the levers or joysticks from the neutral position when turning the key to RUN or START with the BICS™ activated.

! WARNING

AVOID INJURY OR DEATH

- Fasten seat belt, start and operate only from the operator's seat.
- Never wear loose clothing when working near machine.

W-2135-1108

STARTING THE ENGINE (CONT'D)

Standard Key Panel (Cont'd)

Figure 112

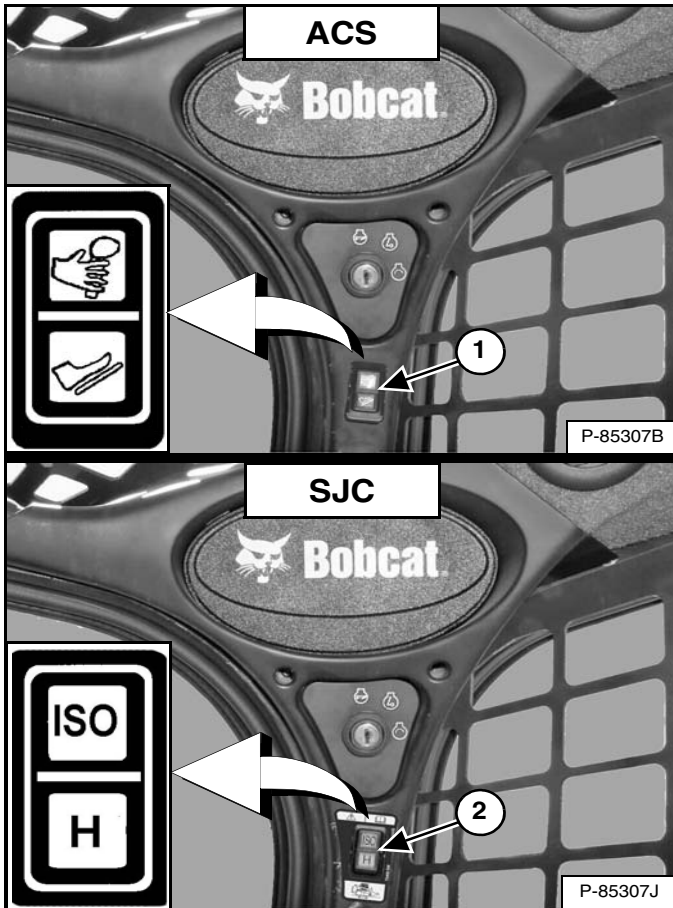

(ACS) Select hand control or foot pedal operation (Item 1) [Figure 112] if equipped with ACS.

OR

(SJC) Select 'ISO' or 'H' Control Pattern (Item 2) [Figure 112] if equipped with SJC.

Figure 113

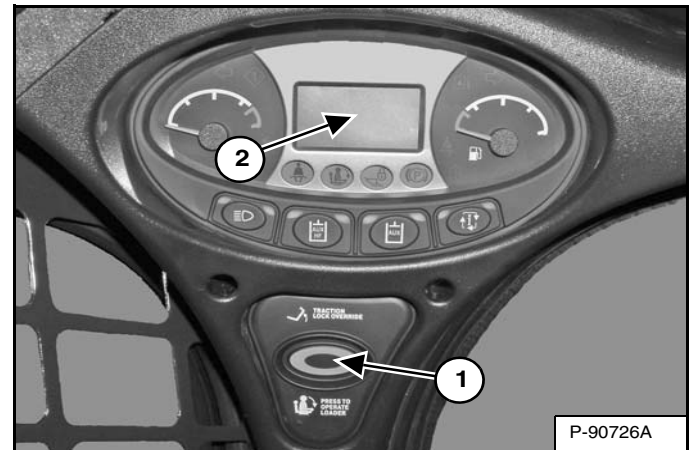

Press the PRESS TO OPERATE LOADER button (Item 1) [Figure 113] to activate the BICS™ and to perform hydraulic and loader functions.

(SJC) The current drive response setting will be displayed briefly in the data display (Item 2) each time the PRESS TO OPERATE LOADER button (Item 1) [Figure 113] is pressed.

NOTE: (SJC) The light of the current switch position (ISO or H) will flash, which will indicate PRESS TO OPERATE LOADER is required. The light will flash when the key switch is ON and continue to flash until the PRESS TO OPERATE LOADER button is pressed, thereafter the light will become solid. If the mode (ISO / H) is changed while driving, the active mode light will remain solid and the pending mode light will flash. When operation of the machine is returned to neutral, the active mode light will then turn off and the pending mode light will continue to flash until the PRESS TO OPERATE LOADER button is pressed.

! WARNING

AVOID INJURY OR DEATH

When an engine is running in an enclosed area, fresh air must be added to avoid concentration of exhaust fumes. If the engine is stationary, vent the exhaust outside. Exhaust fumes contain odorless, invisible gases which can kill without warning.

W-2050-0807

STARTING THE ENGINE (CONT'D)

Keyless Start Panel

! WARNING

AVOID INJURY OR DEATH

- Engines can have hot parts and hot exhaust gas. Keep flammable material away.
- Do not use machines in atmosphere containing explosive gas.

W-2051-1086

Perform the PRE-STARTING PROCEDURE. (See PRE-STARTING PROCEDURE on Page 88.)

Figure 114

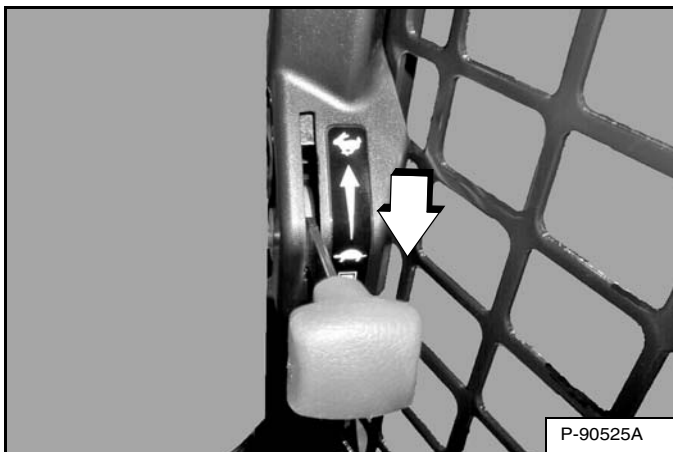

Set the engine speed control to the idle position [Figure 114].

NOTE: Loaders with a Keyless Start Panel have a permanent, randomly generated Master Password set at the factory. Your loader will also have an Owner Password. The owner password can be changed to prevent unauthorised use of your loader. (See Changing The Owner Password on Page 195.) Keep your password in a safe place for future needs.

NOTE: The Password Lockout feature can be used to allow starting of the loader without a password. (See Password Lockout Feature on Page 195.)

Figure 115

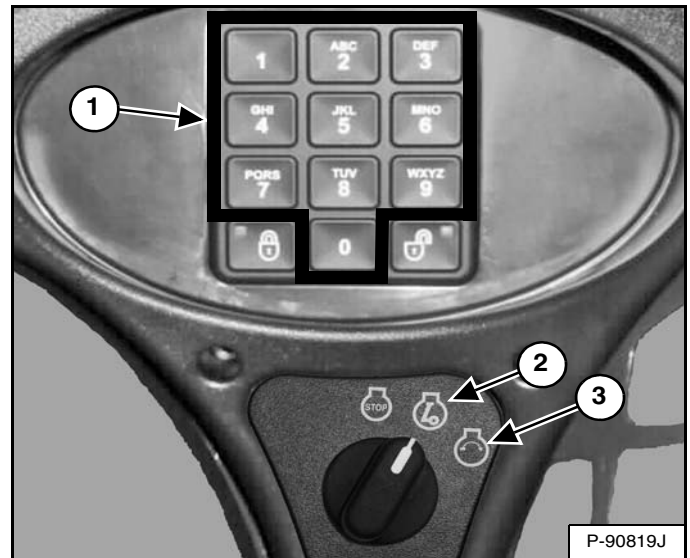

Turn the key switch to RUN (Item 2) [Figure 115]. The indicator lights on the left instrument panel will come ON briefly and the Instrument Panel / monitoring system will do a self test.

Use the numeric keypad (Item 1) [Figure 115] to enter the password.

Figure 116

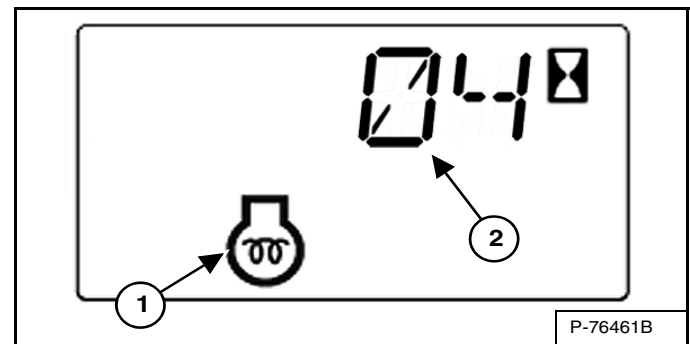

The machine will cycle the air intake heater automatically based on temperature. The engine preheat icon (Item 1) will be ON and the cycle time remaining (Item 2) [Figure 116] will show in the data display.

When the engine preheat icon goes OFF, turn the key switch to START (Item 3). Release the switch when the engine starts and allow it to return to the RUN position (Item 2) [Figure 115].

STARTING THE ENGINE (CONT'D)

Keyless Start Panel (Cont'd)

NOTE: Make sure both hand controls (ACS / AHC) or joysticks (SJC) are in the neutral position before starting the engine. Do not move the levers or joysticks from the neutral position when turning the key switch to RUN or START with the BICS™ activated.



AVOID INJURY OR DEATH

- Fasten seat belt, start and operate only from the operator's seat.
- Never wear loose clothing when working near machine.

W-2135-1108

Figure 117

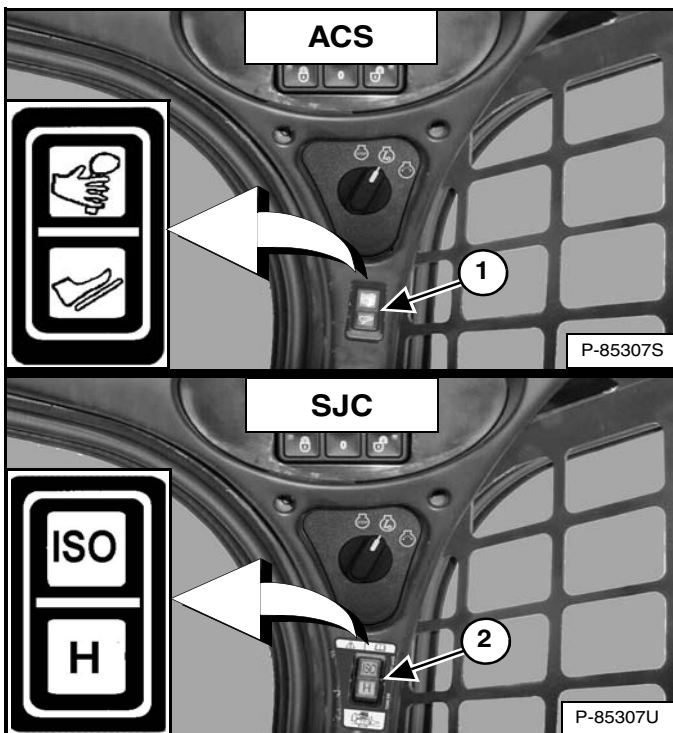

(ACS) Select hand control or foot pedal operation (Item 1) [Figure 117] if equipped with ACS.

OR

(SJC) Select 'ISO' or 'H' Control Pattern (Item 2) [Figure 117] if equipped with SJC.

Figure 118

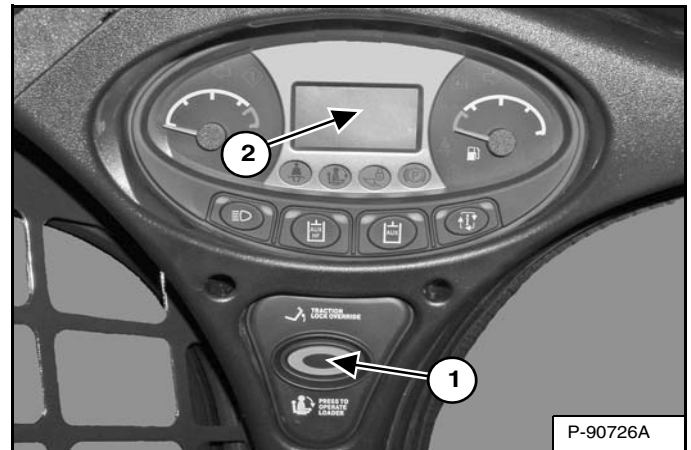

Press the PRESS TO OPERATE LOADER button (Item 1) [Figure 118] to activate the BICS™ and to perform hydraulic and loader functions.

(SJC) The current drive response setting will be displayed briefly in the data display (Item 2) each time the PRESS TO OPERATE LOADER button (Item 1) [Figure 118] is pressed.

NOTE: (SJC) The light of the current switch position (ISO or H) will flash, which will indicate PRESS TO OPERATE LOADER is required. The light will flash when the key switch is ON and continue to flash until the PRESS TO OPERATE LOADER button is pressed, thereafter the light will become solid. If the mode (ISO / H) is changed while driving, the active mode light will remain solid and the pending mode light will flash. When operation of the machine is returned to neutral, the active mode light will then turn off and the pending mode light will continue to flash until the PRESS TO OPERATE LOADER button is pressed.



AVOID INJURY OR DEATH

When an engine is running in an enclosed area, fresh air must be added to avoid concentration of exhaust fumes. If the engine is stationary, vent the exhaust outside. Exhaust fumes contain odorless, invisible gases which can kill without warning.

W-2050-0807

STARTING THE ENGINE (CONT'D)

Deluxe Instrumentation Panel

WARNING

AVOID INJURY OR DEATH

- Engines can have hot parts and hot exhaust gas. Keep flammable material away.
- Do not use machines in atmosphere containing explosive gas.

W-2051-1086

Perform the PRE-STARTING PROCEDURE. (See PRE-STARTING PROCEDURE on Page 88.)

Figure 119

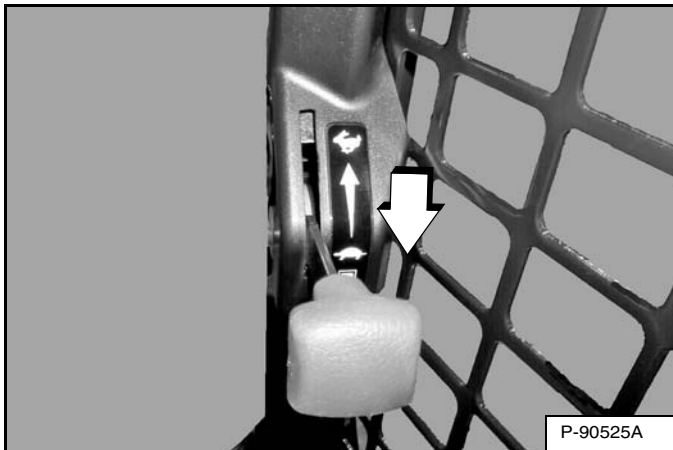

Set the engine speed control to the idle position [Figure 119].

NOTE: Loaders with a Deluxe Instrumentation Panel have a permanent, randomly generated Master Password set at the factory. Your loader will also be assigned an Owner Password. Your dealer will provide you with this password. Change the owner password to one that you will easily remember to prevent unauthorised use of your loader. (See Changing The Owner Password on Page 196.) Keep your password in a safe place for future needs.

NOTE: The Password Lockout feature can be used to allow starting of the loader without a password. (See Password Lockout Feature on Page 197.)

Figure 120



Turn the key switch to RUN (Item 2) [Figure 120]. The indicator lights on the left instrument panel will come ON briefly and the Instrument Panel / monitoring system will do a self test.

Use the numeric keypad (Item 1) [Figure 120] to enter the password.

Figure 121

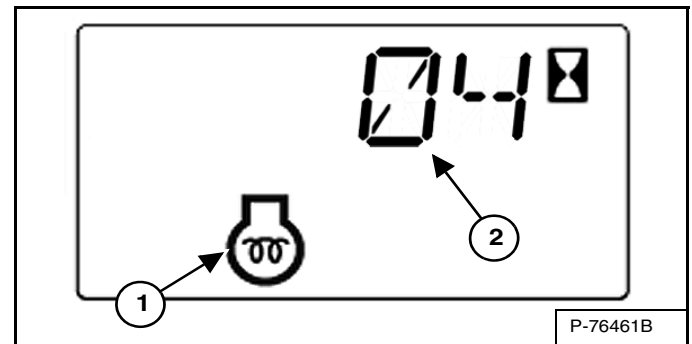

The machine will cycle the air intake heater automatically based on temperature. The engine preheat icon (Item 1) will be ON and the cycle time remaining (Item 2) [Figure 121] will show in the data display.

When the engine preheat icon goes OFF, turn the key switch to START (Item 3). Release the switch when the engine starts and allow it to return to the RUN position (Item 2) [Figure 120].

STARTING THE ENGINE (CONT'D)

Deluxe Instrumentation Panel (Cont'd)

NOTE: Make sure both hand controls (ACS / AHC) or joysticks (SJC) are in the neutral position before starting the engine. Do not move the levers or joysticks from the neutral position when turning the key switch to RUN or START with the BICS™ activated.



AVOID INJURY OR DEATH

- Fasten seat belt, start and operate only from the operator's seat.
- Never wear loose clothing when working near machine.

W-2135-1108

Figure 122

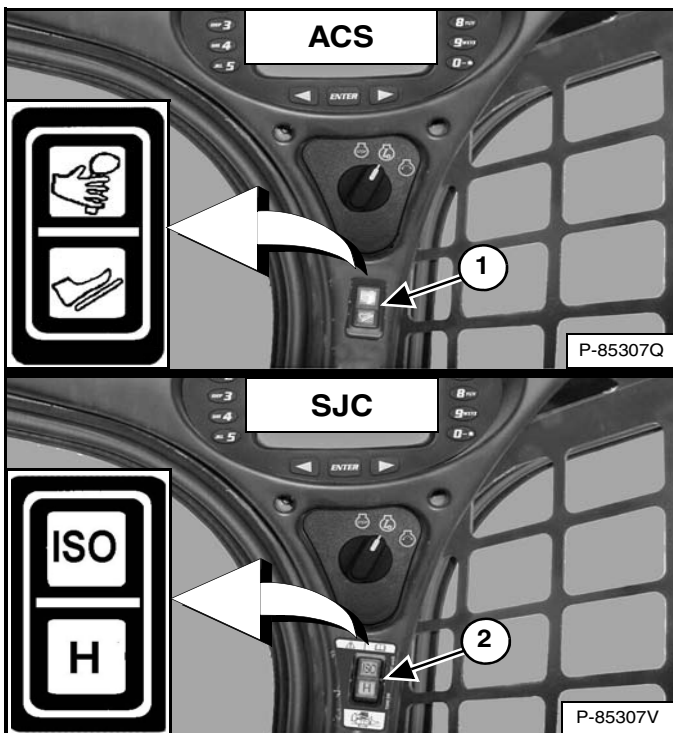

(ACS) Select hand control or foot pedal operation (Item 1) [Figure 122] if equipped with ACS.

OR

(SJC) Select 'ISO' or 'H' Control Pattern (Item 2) [Figure 122] if equipped with SJC.

Figure 123

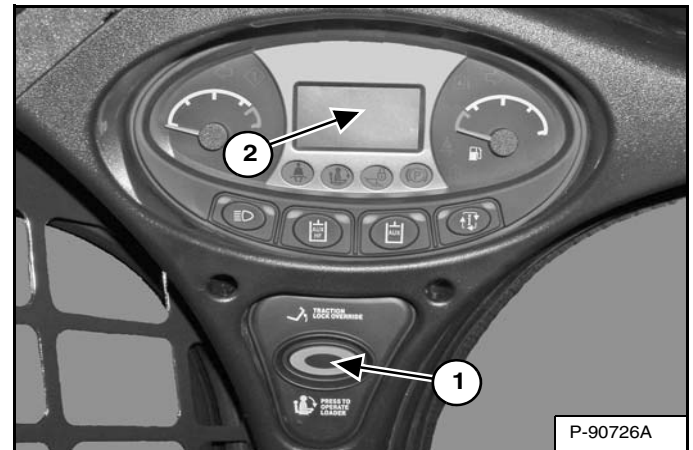

Press the PRESS TO OPERATE LOADER button (Item 1) [Figure 123] to activate the BICS™ and to perform hydraulic and loader functions.

(SJC) The current drive response setting will be displayed briefly in the data display (Item 2) each time the PRESS TO OPERATE LOADER button (Item 1) [Figure 123] is pressed.

NOTE: (SJC) The light of the current switch position (ISO or H) will flash, which will indicate PRESS TO OPERATE LOADER is required. The light will flash when the key switch is ON and continue to flash until the PRESS TO OPERATE LOADER button is pressed, thereafter the light will become solid. If the mode (ISO / H) is changed while driving, the active mode light will remain solid and the pending mode light will flash. When operation of the machine is returned to neutral, the active mode light will then turn off and the pending mode light will continue to flash until the PRESS TO OPERATE LOADER button is pressed.



AVOID INJURY OR DEATH

When an engine is running in an enclosed area, fresh air must be added to avoid concentration of exhaust fumes. If the engine is stationary, vent the exhaust outside. Exhaust fumes contain odorless, invisible gases which can kill without warning.

W-2050-0807

STARTING THE ENGINE (CONT'D)

Cold Temperature Starting

! WARNING

AVOID INJURY OR DEATH

Do not use ether with glow plug (preheat) systems. Explosion can result which can cause injury, death, or severe engine damage.

W-2071-0907

If the temperature is below freezing, perform the following to make starting the engine easier:

- Replace the engine oil with the correct type and viscosity for the anticipated starting temperature. (See Engine Oil Chart on Page 153.)
- Make sure the battery is fully charged.
- Install an engine heater, available from your Bobcat loader dealer.
- Move engine speed control lever halfway before starting. Return to idle position after the engine starts.

NOTE: The display screen of the Deluxe Instrumentation Panel may not be at full intensity when the temperature is below -26°C (-15°F). It may take 30 seconds to several minutes for the display screen to warm up. All systems remain monitored even when the display screen is off.

Warming The Hydraulic / Hydrostatic System

IMPORTANT

When the temperature is below -30°C (-20°F), hydrostatic oil must be warmed before starting. The hydrostatic system will not get enough oil at low temperatures and will be damaged. Park the machine in an area where the temperature will be above -18°C (0°F) if possible.

I-2007-0910

Let the engine run for a minimum of five minutes to warm the engine and hydrostatic transmission fluid before operating the loader.

MONITORING THE DISPLAY PANELS

Left Panel

Figure 124



Frequently monitor the temperature and fuel gauges and BICS™ lights (all BICS™ lights must be OFF to operate loader) [Figure 124].

After the engine is running, frequently monitor the left instrument panel [Figure 124] for machine condition.

The associated icon will be ON if there is an error condition.

EXAMPLE: Engine Coolant Temperature is High.

The Engine Over-Temperature icon (Item 1) [Figure 124] will be ON.

Press the Information button (Item 2) [Figure 124] to cycle the data display until the service code screen is displayed. One of the following SERVICE CODES will be displayed.

- **M0810** Engine Coolant Temperature High
- **M0811** Engine Coolant Temperature Extremely High

Find the cause of the error code and correct before operating the loader again. (See Service Codes List on Page 188.)

Warning And Shutdown

When a WARNING condition exists, the associated icon light will come ON and there will be 3 beeps from the alarm. If this condition is allowed to continue, there may be damage to the engine or loader hydraulic systems.

When a SHUTDOWN condition exists, the associated icon light will come ON and there will be a continuous beep from the alarm. The monitoring system will automatically stop the engine in 15 seconds. The engine can be restarted to move or relocate the loader.

The SHUTDOWN feature is associated with the following icons:

- General Warning**
- Engine Malfunction**
- Engine Coolant Temperature**
- Hydraulic System Malfunction**

STOPPING THE ENGINE AND LEAVING THE LOADER

Procedure

Stop the loader on level ground.

Fully lower the lift arms and put the attachment flat on the ground.

Figure 125

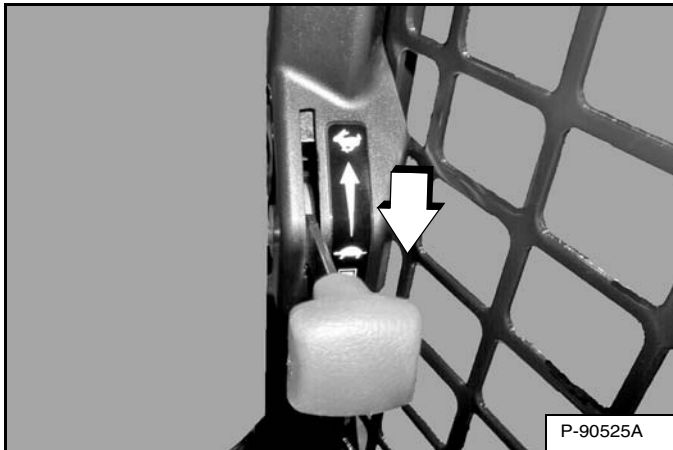

Push the engine speed control fully down [Figure 125] to decrease the engine speed.

Engage the parking brake.

Figure 126

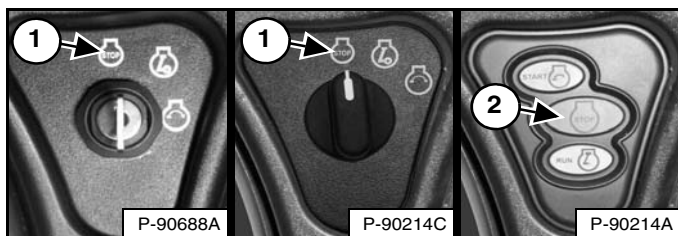

Turn the key switch to the STOP position (Item 1) or press the STOP button (Item 2) [Figure 126].

NOTE: If the loader lights are ON, they will remain ON for approximately 90 seconds after turning the loader OFF.

Raise the seat bar and make sure the lift and tilt functions are deactivated.

Unbuckle the seat belt.

Remove the key from the switch (*Standard Key Panel*) to prevent operation of the loader by unauthorised personnel.

NOTE: Activating the Password Lockout Feature on machines with the Keyless Start Panel or the Deluxe Instrumentation Panel allows operation of the loader without using a password. (See Password Lockout Feature on Page 195.) or (See Password Lockout Feature on Page 197.)

Figure 127



Exit the loader using grab handles, safety tread and steps (maintaining a 3-point contact) [Figure 127].

WARNING

AVOID INJURY OR DEATH

Before you leave the operator's seat:

- Lower the lift arms and put the attachment flat on the ground.
- Stop the engine.
- Engage the parking brake.
- Raise the seat bar.
- Move all controls to the NEUTRAL / LOCKED position to make sure the lift, tilt and traction drive functions are deactivated.

The seat bar system must deactivate these functions when the seat bar is up. See your Bobcat dealer for service if controls do not deactivate.

W-2463-1110



COUNTERWEIGHTS

Description

Counterweights can be installed on the loader. See your Bobcat dealer for information about approved loader counterweights and configurations for your job application and attachment.

Effect On The Loader And Loader Operation

Proper operation of the loader and attachment does not change if counterweights are installed on this loader. Always follow the instructions provided in this manual when operating your loader with counterweights installed.

Counterweights installed on your loader can affect the loader and its operation in some applications. Some examples are:

- Increased machine weight.
- Increased Rated Operating Capacity (ROC).
- Harder steering.
- Accelerated or uneven tyre wear.
- Increased power consumption.

When To Consider Using Counterweights

Install counterweights to increase the loaders Rated Operating Capacity (ROC) which could improve attachment performance in some applications. Some examples are:

- Using pallet fork with palletized loads.
- Using grapples or bale fork.
- Using buckets to handle loose material without digging.

When To Consider Removing Counterweights

Remove counterweights to increase the downward force of the attachment for better attachment performance in some applications. Some examples are:

- Digging with buckets.
- Using Hydraulic Breakers, Scrapers or Landplanes.

Accessories That Affect Machine Weight

If your loader is already equipped with accessories like Over Tyre Steel Tracks, Water Tanks or Rear Stabilisers, installing counterweights may not be necessary.

See your Bobcat dealer for more information about the proper use of counterweights with your attachments and accessories.

ATTACHMENTS

Choosing The Correct Bucket



AVOID INJURY OR DEATH

Never use attachments or buckets which are not approved by Bobcat Company. Buckets and attachments for safe loads of specified densities are approved for each model. Unapproved attachments can cause injury or death.

W-2052-0907

NOTE: Warranty is void if non-approved attachments are used on the Bobcat loader.

The dealer can identify, for each model loader, the attachments and buckets approved by Bobcat. The buckets and attachments are approved for Rated Operating Capacity (ROC) and for secure fastening to the Bob-Tach.

The ROC for this loader is shown on a decal in the operator cab. (See Performance on Page 202.)

The ROC is determined by using a bucket and material of normal density, such as dirt or dry gravel. If longer buckets are used, the load centre moves forward and reduces the ROC. If very dense material is loaded, the volume must be reduced to prevent overloading.

Figure 128

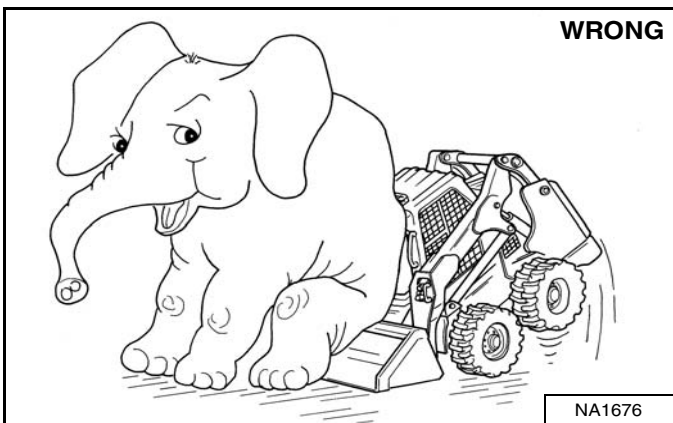

Exceeding the ROC [Figure 128] can cause the following problems:

- Steering the loader may be difficult.
- Tyres will wear faster.
- There will be a loss of stability.
- The life of the Bobcat loader will be reduced.

Use the correct bucket size for the type and density of material being handled. For safe handling of materials and avoiding machine damage, the attachment (or bucket) should handle a full load without going over the ROC for the loader. Partial loads make steering more difficult.

Pallet Fork

Figure 129

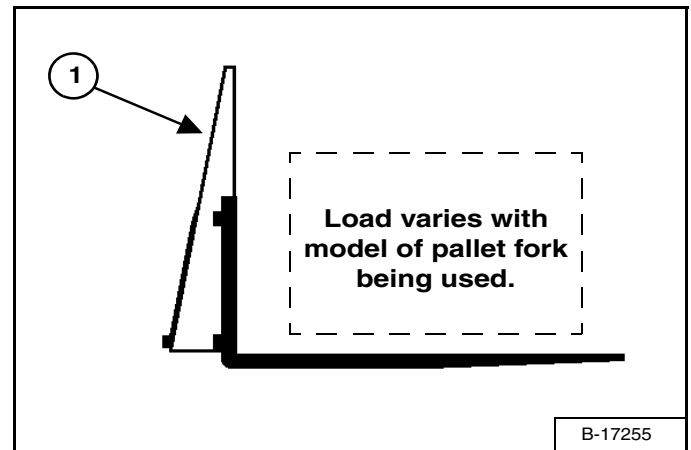

The maximum load to be carried when using a pallet fork is shown on a decal located on the pallet fork frame (Item 1) [Figure 129].

See your Bobcat dealer for more information about pallet fork inspection, maintenance and replacement. See your Bobcat dealer for ROC when using a pallet fork and for other available attachments.



AVOID INJURY OR DEATH

Do not exceed Rated Operating Capacity (ROC). Excessive load can cause tipping or loss of control.

W-2053-0903

ATTACHMENTS (CONT'D)

Installing And Removing The Attachment (Hand Lever Bob-Tach)

The Bob-Tach is used for fast changing of buckets and attachments. See the appropriate attachment Operation & Maintenance Manual to install other attachments.

Figure 130

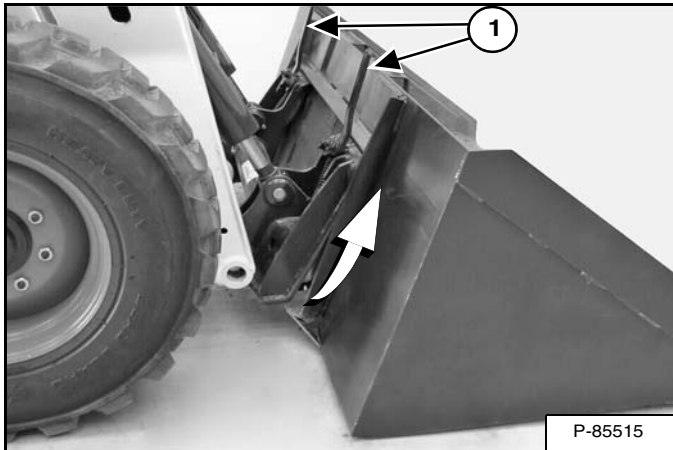

Installing

Pull the Bob-Tach levers up until they are fully raised (Item 1) [Figure 130].

Enter the loader and perform the PRE-STARTING PROCEDURE. (See PRE-STARTING PROCEDURE on Page 88.)

Start the engine, press the PRESS TO OPERATE LOADER button and release the parking brake.

Lower the lift arms and tilt the Bob-Tach forward.

Drive the loader slowly forward until the top edge of the Bob-Tach is completely under the top flange of the bucket mounting frame [Figure 130] (or other attachment).

NOTE Be sure the Bob-Tach levers do not hit the bucket.

Figure 131

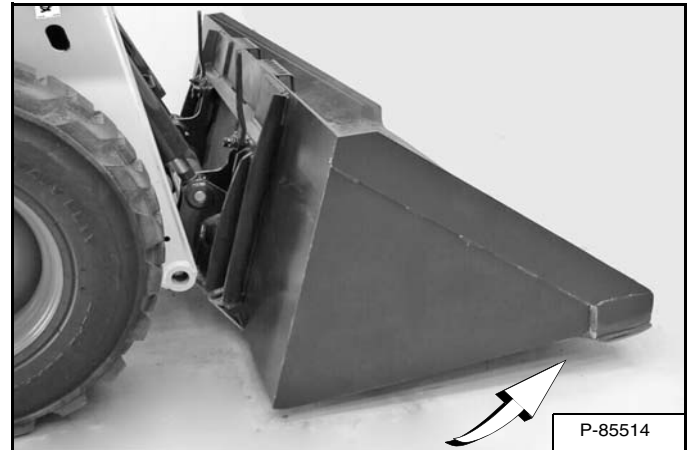

Tilt the Bob-Tach backward until the cutting edge of the bucket (or other attachment) is slightly off the ground [Figure 131]. This will cause the bucket mounting frame to fit up against the front of the Bob-Tach.

Stop the engine and exit the loader. (See STOPPING THE ENGINE AND LEAVING THE LOADER on Page 100.)

WARNING

AVOID INJURY OR DEATH

Before you leave the operator's seat:

- Lower the lift arms and put the attachment flat on the ground.
- Stop the engine.
- Engage the parking brake.
- Raise the seat bar.
- Move all controls to the NEUTRAL / LOCKED position to make sure the lift, tilt and traction drive functions are deactivated.

The seat bar system must deactivate these functions when the seat bar is up. See your Bobcat dealer for service if controls do not deactivate.

W-2463-1110

ATTACHMENTS (CONT'D)

Installing And Removing The Attachment (Hand Lever Bob-Tach) (Cont'd)

Installing (Cont'd)

Figure 132

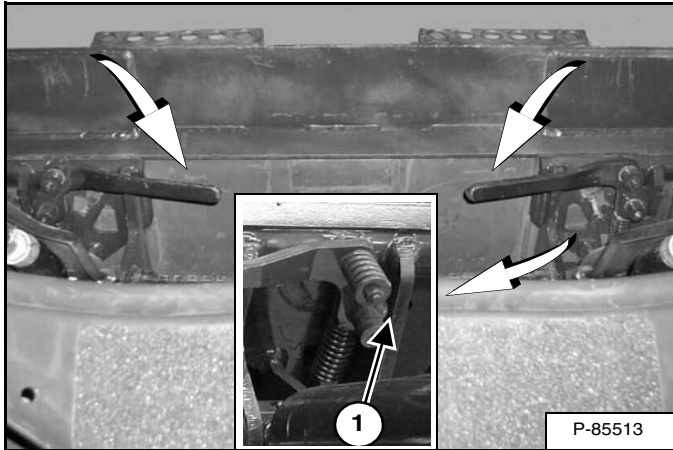

Push down on the Bob-Tach levers until they are fully engaged in the locked position (Item 1) [Figure 132] (wedges fully extended through the attachment mounting frame holes). Both levers must contact the frame as shown when locked (Item 1) [Figure 132].

If both levers do not engage in the locked position, see your Bobcat dealer for maintenance.

Figure 133

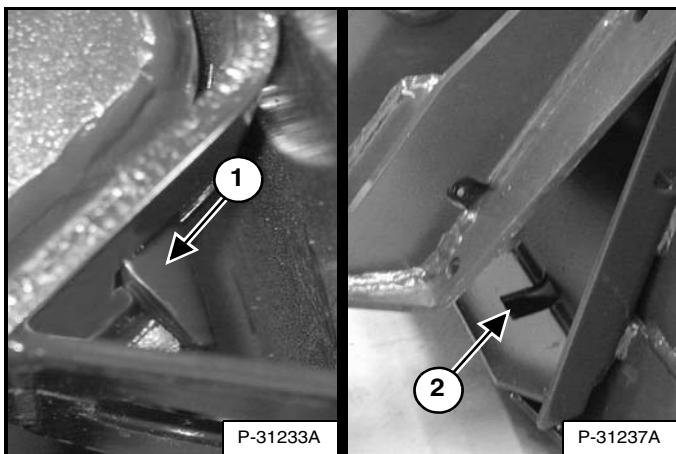

The wedges (Item 1) must extend through the holes (Item 2) [Figure 133] in the mounting frame of the bucket (or other attachment), securely fastening the bucket to the Bob-Tach.

! WARNING

AVOID INJURY OR DEATH

The Bob-Tach wedges must extend through the holes in the attachment mounting frame. Levers must be fully down and locked. Failure to secure wedges can allow attachment to come off.

W-2715-0208

Removing

Lower the lift arms and put the attachment flat on the ground. Lower or close any hydraulic equipment, if applicable.

Stop the engine and exit the loader. (See STOPPING THE ENGINE AND LEAVING THE LOADER on Page 100.)

! WARNING

AVOID INJURY OR DEATH

Before you leave the operator's seat:

- Lower the lift arms and put the attachment flat on the ground.
- Stop the engine.
- Engage the parking brake.
- Raise the seat bar.
- Move all controls to the NEUTRAL / LOCKED position to make sure the lift, tilt and traction drive functions are deactivated.

The seat bar system must deactivate these functions when the seat bar is up. See your Bobcat dealer for service if controls do not deactivate.

W-2463-1110

Disconnect attachment electrical harness, water line and hydraulic lines, if applicable, from the loader. (See Relieve Auxiliary Hydraulic Pressure (Loader And Attachment) on Page 84.)

ATTACHMENTS (CONT'D)

Installing And Removing The Attachment (Hand Lever Bob-Tach) (Cont'd)

Removing (Cont'd)

Figure 134

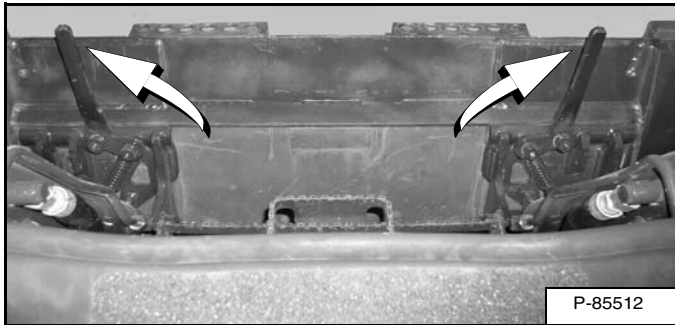

Pull the Bob-Tach levers up [Figure 134] until they are fully raised (wedges fully raised).



Bob-Tach levers have spring tension. Hold lever tightly and release slowly. Failure to obey warning can cause injury.

W-2054-1285

Enter the loader and perform the PRE-STARTING PROCEDURE. (See PRE-STARTING PROCEDURE on Page 88.)

Start the engine, press the PRESS TO OPERATE LOADER button and release the parking brake.

Figure 135

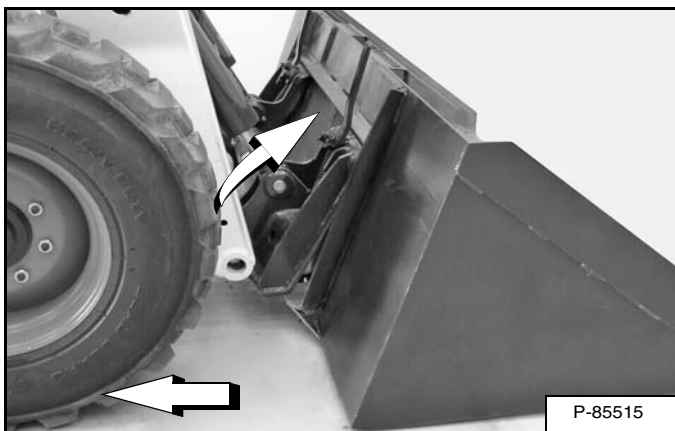

Tilt the Bob-Tach forward and drive the loader backward, away from the bucket or attachment [Figure 135].

Installing And Removing The Attachment (Power Bob-Tach)

This machine may be equipped with a Power Bob-Tach.

Installing

The Power Bob-Tach is used for fast changing of buckets and attachments. See the appropriate attachment Operation & Maintenance Manual to install other attachments.

Enter the loader and perform the PRE-STARTING PROCEDURE. (See PRE-STARTING PROCEDURE on Page 88.)

Start the engine, press the PRESS TO OPERATE LOADER button and release the parking brake.

Lower the lift arms and tilt the Bob-Tach forward.

Figure 136

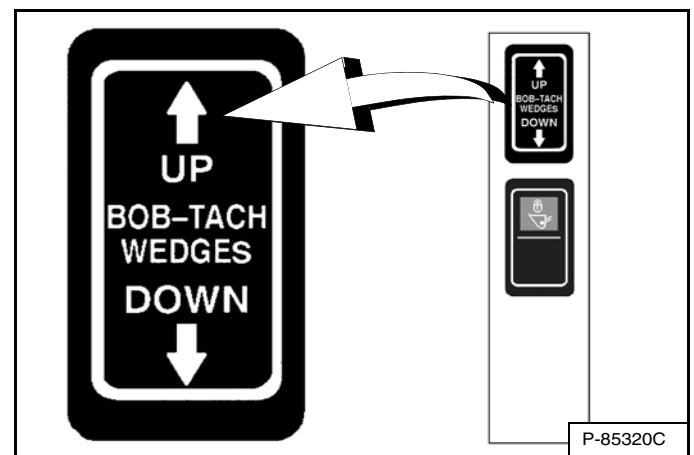
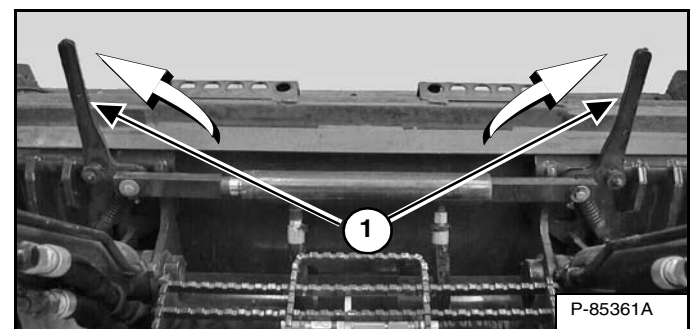

Figure 137



Push and hold BOB-TACH “WEDGES UP” switch (Right Switch Panel) [Figure 136] until levers (Item 1) [Figure 137] are fully raised (wedges fully raised).

ATTACHMENTS (CONT'D)

Installing And Removing The Attachment (Power Bob-Tach) (Cont'd)

Installing (Cont'd)

Figure 138

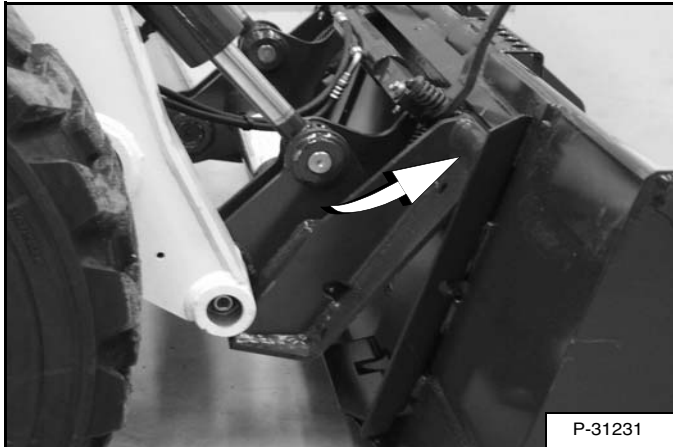

Drive the loader slowly forward until the top edge of the Bob-Tach is completely under the top flange of the bucket mounting frame [Figure 138] (or other attachment).

NOTE: Be sure the Bob-Tach levers do not hit the attachment.

Figure 139



Tilt the Bob-Tach backward until the cutting edge of the bucket (or other attachment) is slightly off the ground [Figure 139]. This will cause the bucket mounting frame to fit up against the front of the Bob-Tach.

Figure 140

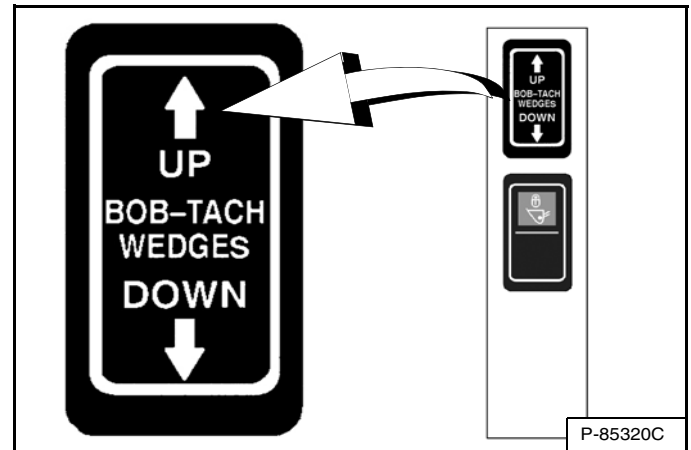

Push and hold BOB-TACH "WEDGES UP" switch (Right Switch Panel) [Figure 140] to make sure the levers are fully raised (wedges fully raised).

NOTE: The Power Bob-Tach system has continuous pressurised hydraulic oil to keep the wedges in the engaged position and prevent attachment disengagement. Because the wedges can slowly lower, the operator may need to reactivate the switch (BOB-TACH WEDGES UP) to be sure both wedges are fully raised before installing the attachment.

ATTACHMENTS (CONT'D)

Installing And Removing The Attachment (Power Bob-Tach) (Cont'd)

Installing (Cont'd)

Figure 141

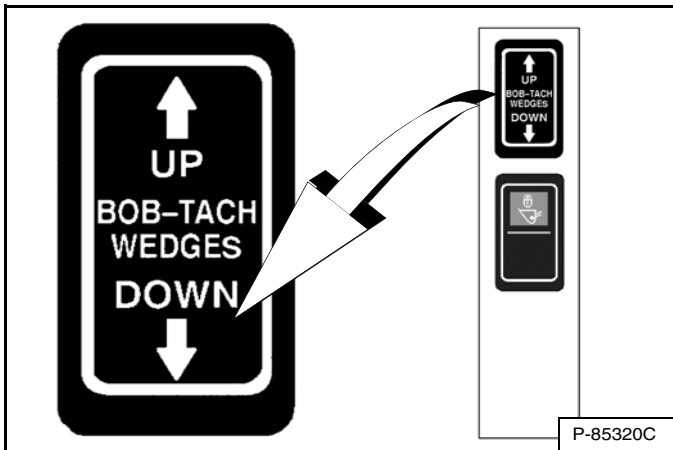
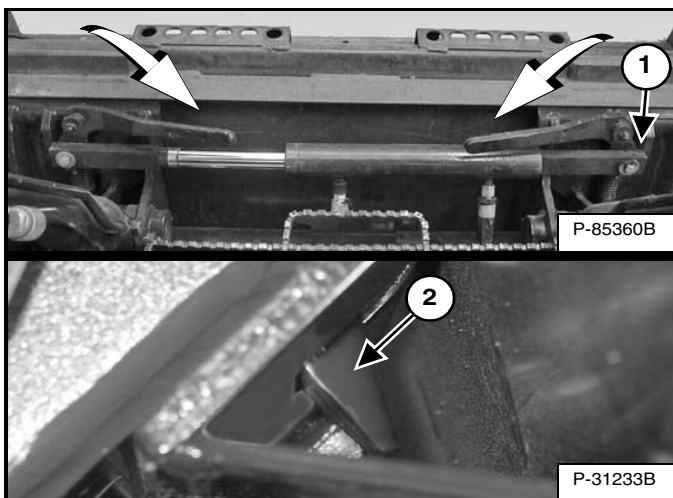

Figure 142



Push and hold BOB-TACH “WEDGES DOWN” switch (Right Switch Panel) [Figure 141] until levers are fully engaged in the locked position [Figure 142] (wedges fully extended through the attachment mounting frame holes).

Both levers must contact the frame as shown when locked (Item 1) [Figure 142].

If both levers do not engage in the locked position, see your Bobcat dealer for maintenance.

The wedges (Item 2) [Figure 142] must extend through the holes in the mounting frame of the bucket (or other attachment), securely fastening the bucket to the Bob-Tach.

! WARNING

AVOID INJURY OR DEATH

The Bob-Tach wedges must extend through the holes in the attachment mounting frame. Levers must be fully down and locked. Failure to secure wedges can allow attachment to come off.

W-2715-0208

ATTACHMENTS (CONT'D)

Installing And Removing The Attachment (Power Bob-Tach) (Cont'd)

Removing

Lower the lift arms and put the attachment flat on the ground. Lower or close any hydraulic equipment, if applicable.

If the attachment has electrical, water or hydraulic connections to the loader:

1. Stop the engine and exit the loader. (See STOPPING THE ENGINE AND LEAVING THE LOADER on Page 100.)



AVOID INJURY OR DEATH

Before you leave the operator's seat:

- Lower the lift arms and put the attachment flat on the ground.
- Stop the engine.
- Engage the parking brake.
- Raise the seat bar.
- Move all controls to the **NEUTRAL / LOCKED** position to make sure the lift, tilt and traction drive functions are deactivated.

The seat bar system must deactivate these functions when the seat bar is up. See your Bobcat dealer for service if controls do not deactivate.

W-2463-1110

2. Disconnect attachment electrical harness and water or hydraulic lines, if applicable, from the loader. (See Relieve Auxiliary Hydraulic Pressure (Loader And Attachment) on Page 84.)
3. Enter the loader and perform the PRE-STARTING PROCEDURE. (See PRE-STARTING PROCEDURE on Page 88.)
4. Start the engine, press the PRESS TO OPERATE LOADER button and release the parking brake.

Figure 143

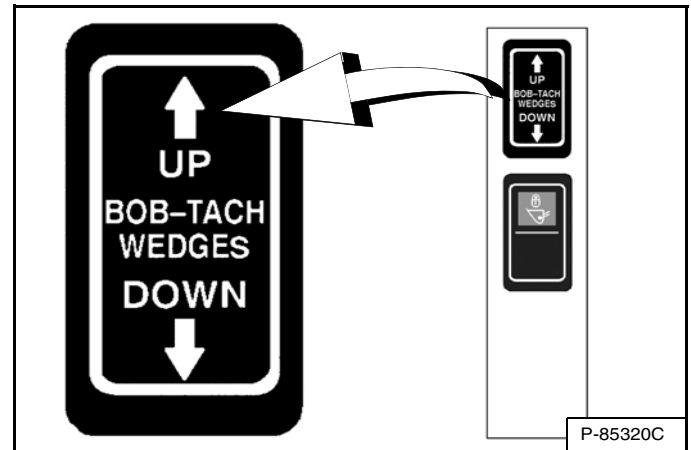
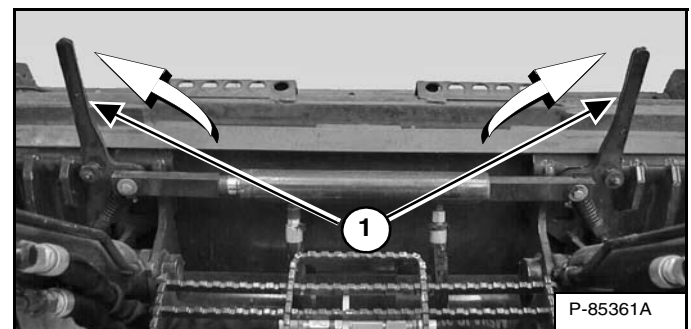

Figure 144



Push and hold BOB-TACH "WEDGES UP" switch (Right Switch Panel) [Figure 143] until levers (Item 1) [Figure 144] are fully raised (wedges fully raised).

ATTACHMENTS (CONT'D)

Installing And Removing The Attachment (Power Bob-Tach) (Cont'd)

Removing (Cont'd)

Figure 145

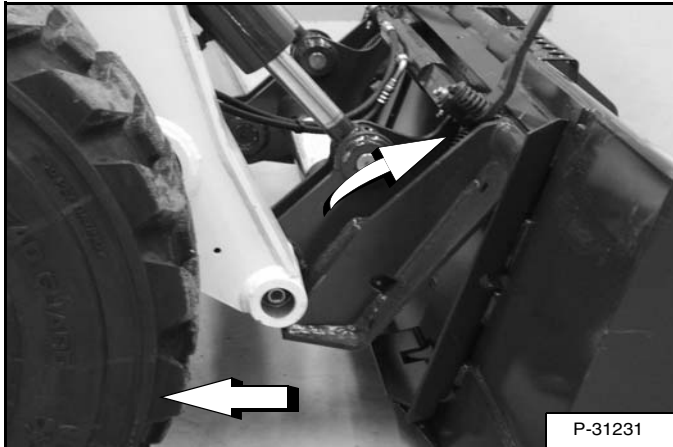

Tilt the Bob-Tach forward and drive the loader backward, away from the bucket or attachment [Figure 145].

NOTE: The Power Bob-Tach system has continuous pressurised hydraulic oil to keep the wedges in the engaged position and prevent attachment disengagement. Because the wedges can slowly lower, the operator may need to reactivate the switch (BOB-TACH WEDGES UP) when removing an attachment to be sure both wedges are fully raised.



OPERATING PROCEDURE

Inspect The Work Area

Before beginning operation, inspect the work area for unsafe conditions.

Look for sharp drop-offs or rough terrain. Have underground utility lines (gas, electrical, water, sewer, irrigation, etc.) located and marked.

Remove objects or other construction material that could damage the loader or cause personal injury.

Always check ground conditions before starting your work:

- Inspect for signs of instability such as cracks or settlement.
- Be aware of weather conditions that can affect ground stability.
- Check for adequate traction if working on a slope.

Basic Operating Instructions

Always warm the engine and hydrostatic system before operating the loader.

IMPORTANT

Machines warmed up with moderate engine speed and light load have longer life.

I-2015-0284

Operate the loader with engine at full speed for maximum horsepower. Move the steering controls only a small amount to operate the loader slowly.

New operators must operate the loader in an open area without bystanders. Operate the controls until the loader can be handled at an efficient and safe rate for all conditions of the work area.

Operating Near An Edge Or Water

Keep the loader as far back from the edge as possible and the loader wheels perpendicular to the edge so that if part of the edge collapses, the loader can be moved back.

Always move the loader back at any indication the edge may be unstable.

WARNING

MACHINE TIPPING OR ROLL OVER CAN CAUSE SERIOUS INJURY OR DEATH

- **Keep the lift arms as low as possible.**
- **Do not travel or turn with the lift arms up.**
- **Turn on level ground. Slow down when turning.**
- **Go up and down slopes, not across them.**
- **Keep the heavy end of the machine uphill.**
- **Do not overload the machine.**
- **Check for adequate traction.**

W-2018-1109

Driving On Public Roads

When operating on a public road or motorway, always follow local regulations. For example: Slow Moving Vehicle Sign or direction signals may be required.

NOTE: Road Option kits are available from your Bobcat dealer to equip your machine for driving on public roads in European Union (EU) countries.

Always follow local regulations. For more information, contact your local Bobcat dealer.

OPERATING PROCEDURE (CONT'D)

Operating With A Full Bucket

Figure 146

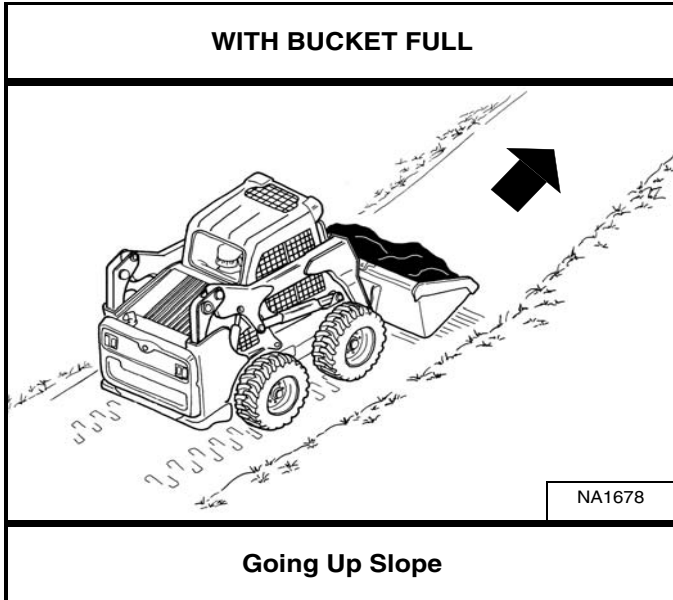
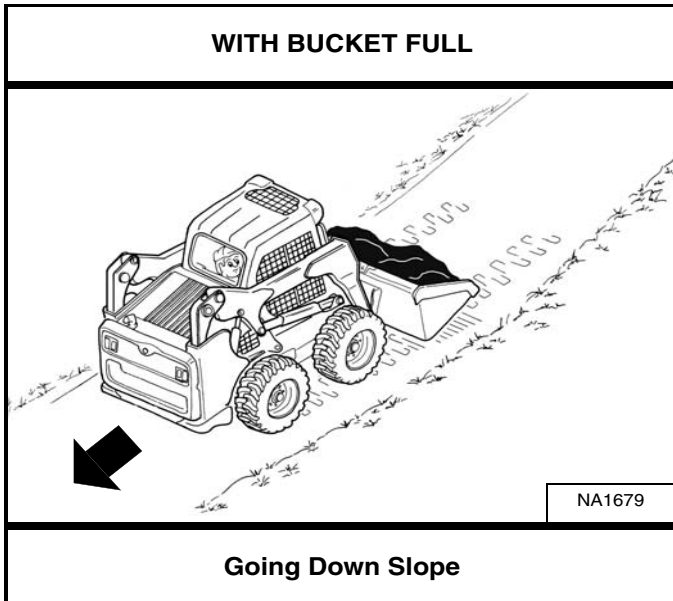

Figure 147



With a full bucket, go up or down the slope with the heavy end toward the top of the slope [Figure 146] and [Figure 147].

Operating With An Empty Bucket

Figure 148

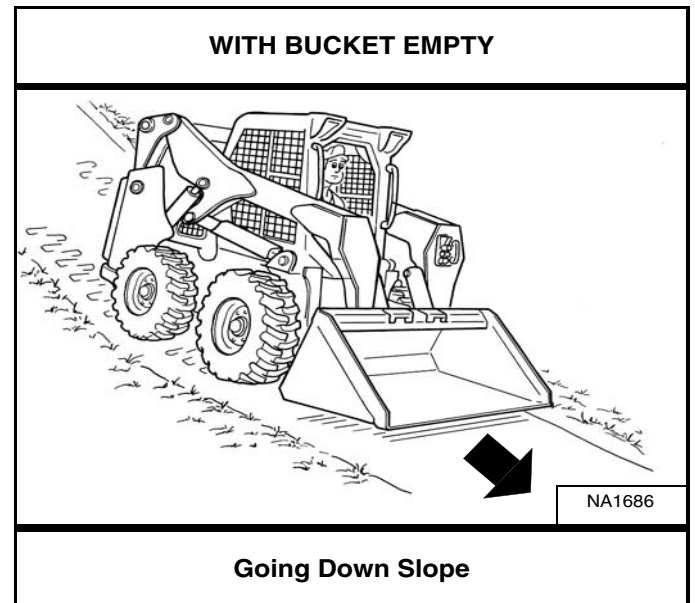
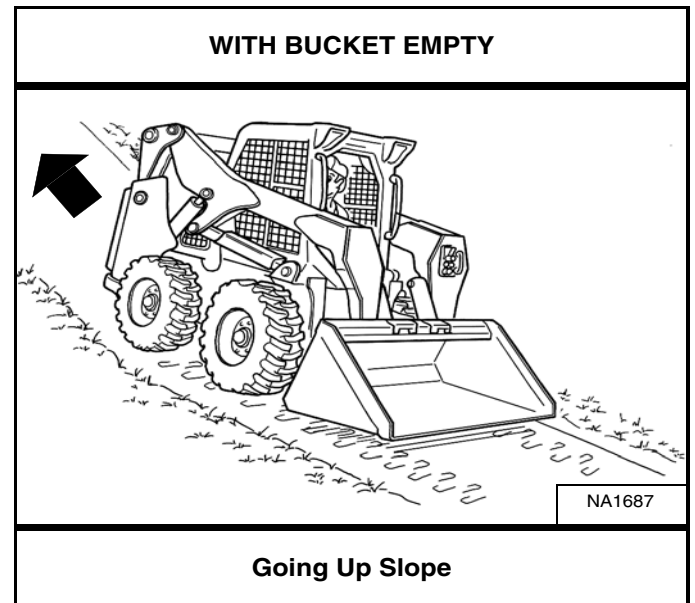

Figure 149



With an empty bucket, go down or up the slope with the heavy end toward the top of the slope [Figure 148] and [Figure 149].

Raise the bucket only high enough to avoid obstructions on rough ground.

OPERATING PROCEDURE (CONT'D)

Filling And Emptying The Bucket (Foot Pedals)

Filling

Figure 150

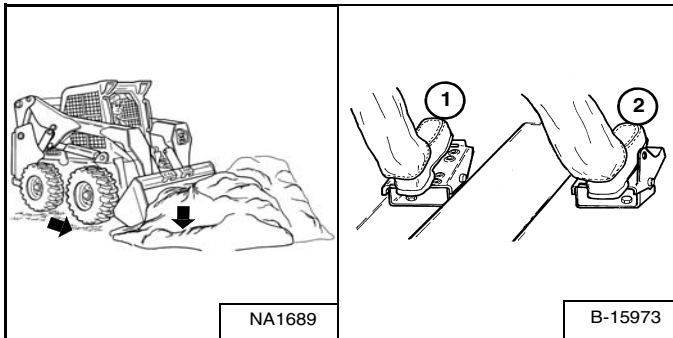
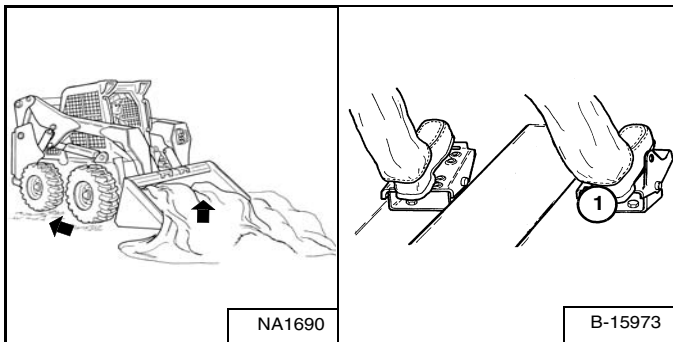

Figure 151



Lower the lift arms all the way (Item 1) [Figure 150].

Tilt the bucket forward (Item 2) [Figure 150] until the cutting edge of the bucket is on the ground.

Drive slowly forward into the material. Tilt the bucket backward (Item 1) [Figure 151] all the way when the bucket is full.

Drive backward away from the material.



Load, unload and turn on flat level ground. Do not exceed Rated Operating Capacity (ROC) shown on sign (decal) in cab. Failure to obey warnings can cause the machine to tip or roll over and cause injury or death.

W-2056-0903

Emptying

Figure 152

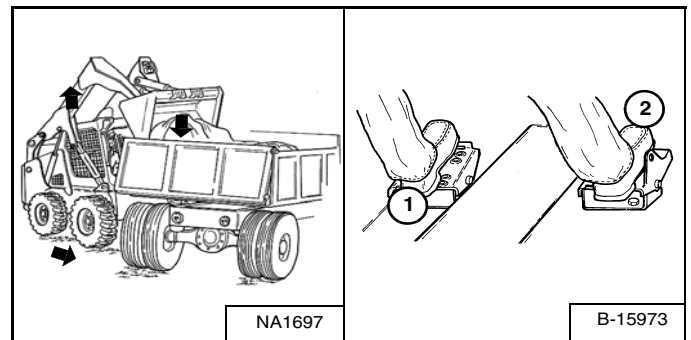

Keep the bucket low when moving to the area where you want to empty the bucket.

Raise the lift arms (Item 1) [Figure 152]. Level the bucket (Item 2) [Figure 152] while raising the lift arms to help prevent material from falling off the back of the bucket.

Drive forward slowly until the bucket is over the top of the truck box or bin.

Empty the bucket (Item 2) [Figure 152]. If all the material is near the side of the truck or bin, use the bucket tilt to move it to the other side.



Never dump over an obstruction, such as a post, that can enter the operator cab. The machine could tip forward and cause injury or death.

W-2057-0694

OPERATING PROCEDURE (CONT'D)

Leveling The Ground Using Float (Foot Pedals)

Figure 153

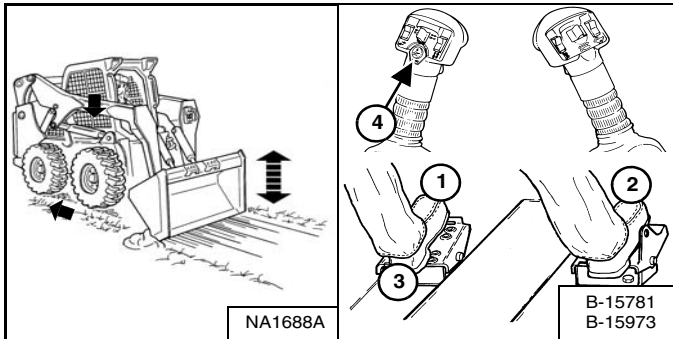

Standard Controls

Put the lift arms in *float* position by pushing the pedal all the way forward (Item 1) [Figure 153] until the pedal is locked in the forward position.

ACS In Foot Pedal Mode

Press and hold the float button (Item 4) on the left handle while the left pedal is in neutral. While lowering the lift arms (Item 1) [Figure 153], release the float button.

Standard Controls And ACS In Foot Pedal Mode

Tilt the bucket forward (Item 2) [Figure 153] to change the position of the cutting edge of the bucket.

With the bucket tilted farther forward, there is more force on the cutting edge and more loose material can be moved.

Drive backward to level loose material.

Push the bottom of the lift pedal (Item 3) [Figure 153] to unlock the float position.

NOTE: On ACS equipped loaders in Foot Pedal Mode, pressing the float button again will disengage float.

IMPORTANT

Never drive forward when the hydraulic control for lift arms is in float position.

I-2005-1285

OPERATING PROCEDURE (CONT'D)

Digging And Filling A Hole (Foot Pedals)

Digging

Figure 154

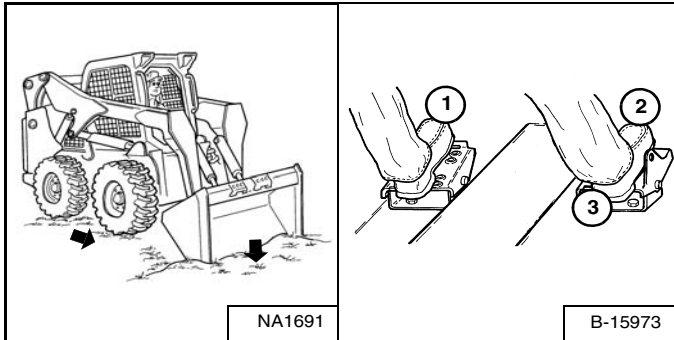

Lower the lift arms all the way (Item 1) [Figure 154]. Put the cutting edge of the bucket on the ground (Item 2) [Figure 154].

Drive forward slowly and continue to tilt the bucket down (Item 2) [Figure 154] until it enters the ground.

Tilt the bucket backward a small amount (Item 3) [Figure 154] to increase traction and keep an even digging depth. Continue to drive forward until the bucket is full. When the ground is hard, raise and lower the cutting edge of the bucket (Items 2 and 3) [Figure 154] while driving forward slowly.

Figure 155

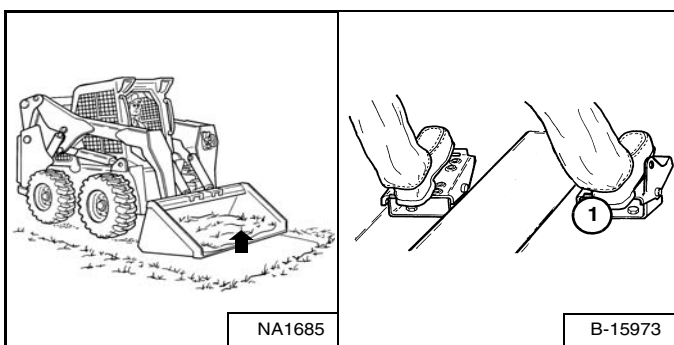

Tilt the bucket backward (Item 1) [Figure 155] as far as it will go when the bucket is full.

Filling

Figure 156

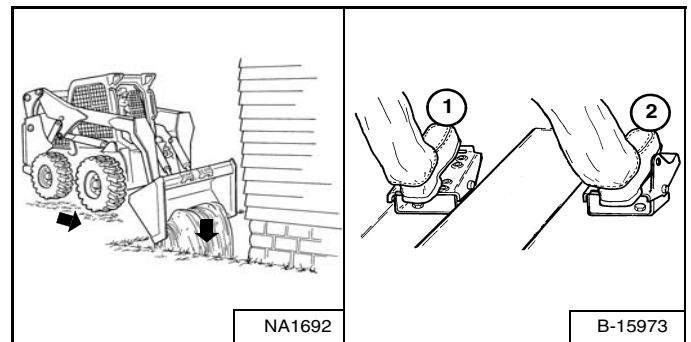

Lower the lift arms (Item 1) [Figure 156] and put the cutting edge of the bucket on the ground (Item 2) [Figure 156]. Drive forward to the edge of the hole to push the material into the hole.

Tilt the bucket forward (Item 2) [Figure 156] as soon as it is past the edge of the hole.

If necessary, raise the lift arms to empty the bucket.

OPERATING PROCEDURE (CONT'D)

Filling And Emptying The Bucket (ACS - Handles, AHC - Handles And SJC - 'H' Pattern)

Filling

Figure 157

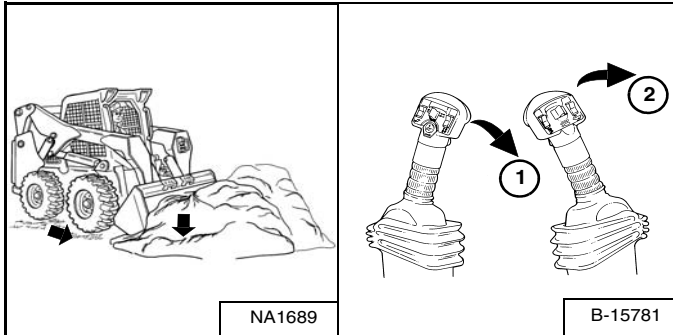
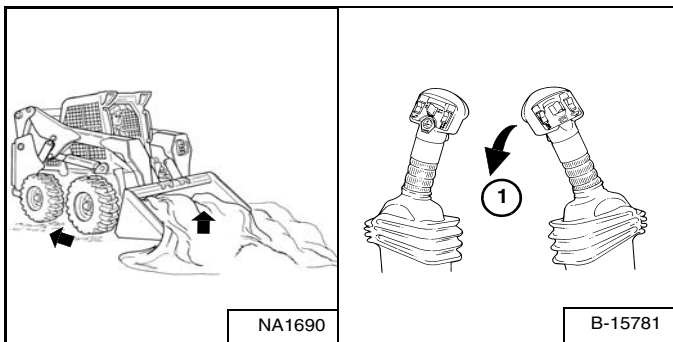

Figure 158



Lower the lift arms all the way (Item 1) [Figure 157].

Tilt the bucket forward (Item 2) [Figure 157] until the cutting edge of the bucket is on the ground.

Drive slowly forward into the material. Tilt the bucket backward (Item 1) [Figure 158] all the way when the bucket is full.

Drive backward away from the material.



Load, unload and turn on flat level ground. Do not exceed Rated Operating Capacity (ROC) shown on sign (decal) in cab. Failure to obey warnings can cause the machine to tip or roll over and cause injury or death.

W-2056-0903

Emptying

Figure 159

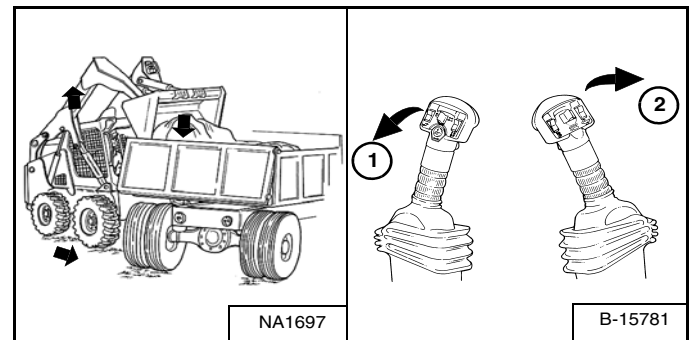

Keep the bucket low when moving to the area where you want to empty the bucket.

Raise the lift arms (Item 1) [Figure 159]. Level the bucket (Item 2) [Figure 159] while raising the lift arms to help prevent material from falling off the back of the bucket.

Drive forward slowly until the bucket is over the top of the truck box or bin.

Empty the bucket (Item 2) [Figure 159]. If all material is near the side of the truck or bin, use the bucket tilt to move it to the other side.



Never dump over an obstruction, such as a post, that can enter the operator cab. The machine could tip forward and cause injury or death.

W-2057-0694

OPERATING PROCEDURE (CONT'D)

Digging And Filling A Hole (ACS - Handles, AHC - Handles And SJC - 'H' Pattern)

Digging

Figure 161

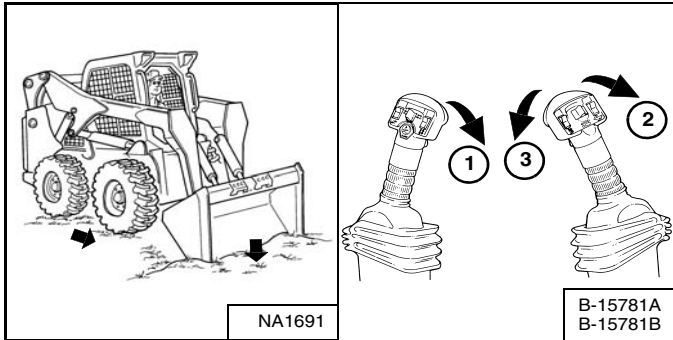

Lower the lift arms all the way (Item 1) [Figure 161]. Tilt the bucket forward (Item 2) [Figure 161] until the cutting edge of the bucket is on the ground.

Drive forward slowly and continue to tilt the bucket down (Item 2) [Figure 161] until it enters the ground.

Tilt the bucket backward a small amount (Item 3) [Figure 161] to increase traction and keep an even digging depth. Continue to drive forward until the bucket is full. When the ground is hard, raise and lower the cutting edge (Items 2 and 3) [Figure 161] while driving forward.

Figure 162

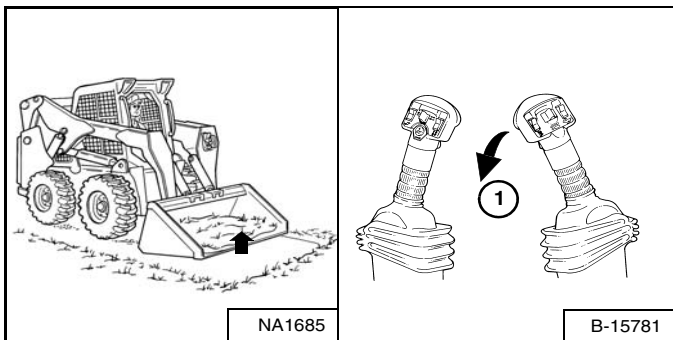

Tilt the bucket backward (Item 1) [Figure 162] as far as it will go when the bucket is full.

Filling

Figure 163

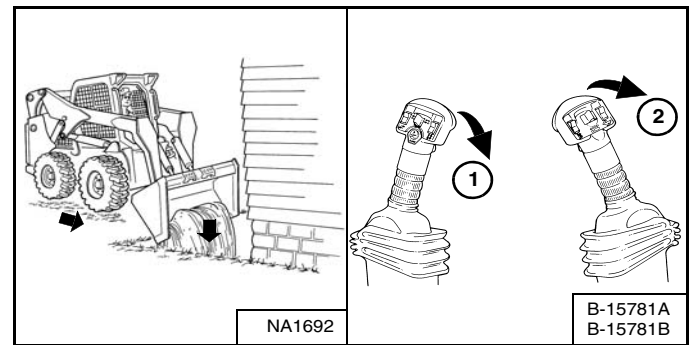

Lower the lift arms (Item 1) [Figure 163] and put the cutting edge of the bucket on the ground (Item 2) [Figure 163]. Drive forward to the edge of the hole to push the material into the hole.

Tilt the bucket forward (Item 2) [Figure 163] as soon as it is past the edge of the hole.

If necessary, raise the lift arms to empty the bucket.

OPERATING PROCEDURE (CONT'D)

Filling And Emptying The Bucket (SJC - 'ISO' Pattern)

Filling

Figure 164

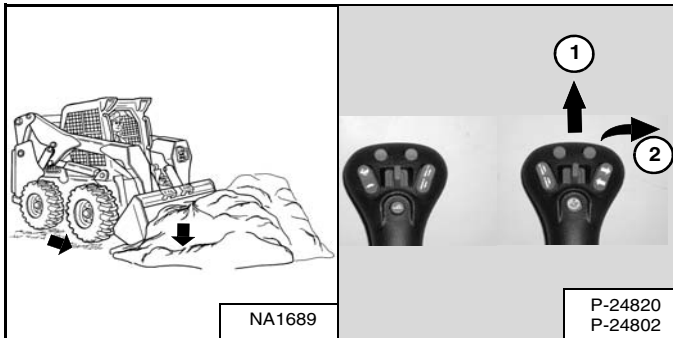
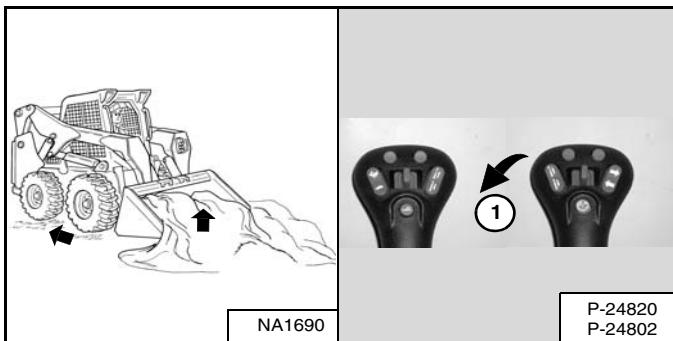

Figure 165



Lower the lift arms all the way (Item 1) [Figure 164].

Tilt the bucket forward (Item 2) [Figure 164] until the cutting edge of the bucket is on the ground.

Drive slowly forward into the material. Tilt the bucket backward (Item 1) [Figure 165] all the way when the bucket is full.

Drive backward away from the material.



Load, unload and turn on flat level ground. Do not exceed Rated Operating Capacity (ROC) shown on sign (decal) in cab. Failure to obey warnings can cause the machine to tip or roll over and cause injury or death.

W-2056-0903

Emptying

Figure 166

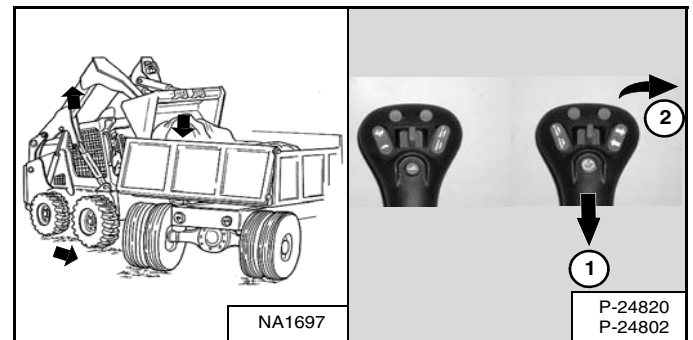

Keep the bucket low when moving to the area where you want to empty the bucket.

Raise the lift arms (Item 1) [Figure 166]. Level the bucket (Item 2) [Figure 166] while raising the lift arms to help prevent material from falling off the back of the bucket.

Drive forward until the bucket is over the top of the truck box or bin.

Empty the bucket (Item 2) [Figure 166]. If all material is near the side of the truck or bin, use the bucket tilt to move it to the other side.



Never dump over an obstruction, such as a post, that can enter the operator cab. The machine could tip forward and cause injury or death.

W-2057-0694

OPERATING PROCEDURE (CONT'D)

Leveling The Ground Using Float (SJC - 'ISO' Pattern)

Figure 167

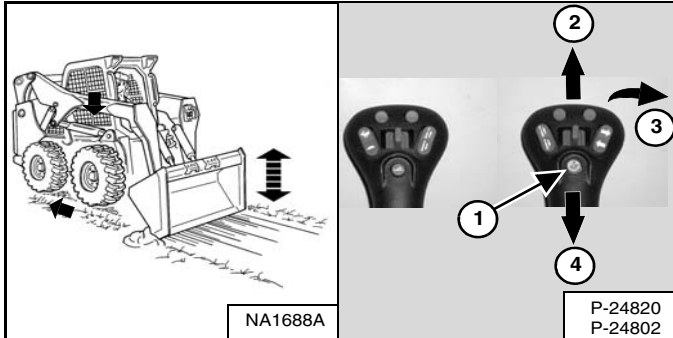

Press and hold the float button (Item 1) [Figure 167] while the joystick is in neutral. While lowering the lift arms (Item 2) [Figure 167], release the float button.

Tilt the bucket forward (Item 3) [Figure 167] to change the position of the cutting edge of the bucket.

With the bucket tilted farther forward, there is more force on the cutting edge and more loose material can be moved.

Drive backward to level loose material.

To disengage, press the float button again or raise the lift arms (Item 4) [Figure 167].

IMPORTANT

Never drive forward when the hydraulic control for lift arms is in float position.

I-2005-1285

OPERATING PROCEDURE (CONT'D)

Digging And Filling A Hole (SJC - 'ISO' Pattern)

Digging

Figure 168

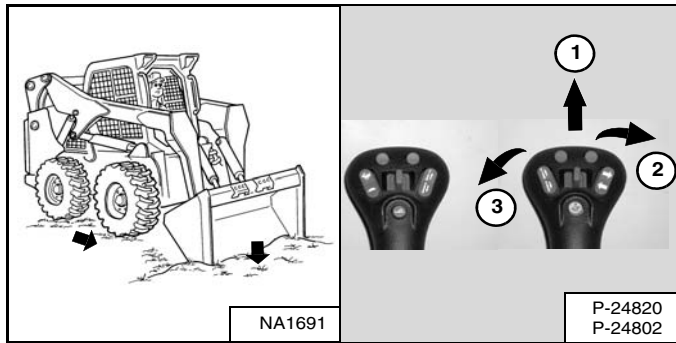

Lower the lift arms all the way (Item 1) [Figure 168]. Put the cutting edge of the bucket on the ground (Item 2) [Figure 168].

Drive forward slowly and continue to tilt the bucket down (Item 2) [Figure 168] until it enters the ground.

Tilt the bucket backward a small amount (Item 3) [Figure 168] to increase traction and keep an even digging depth. Continue to drive forward until the bucket is full. When the ground is hard, raise and lower the cutting edge (Items 2 and 3) [Figure 168] while driving forward.

Figure 169

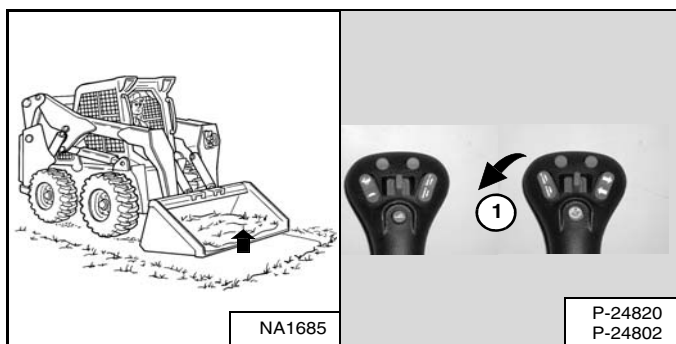

Tilt the bucket backward (Item 1) [Figure 169] as far as it will go when the bucket is full.

Filling

Figure 170

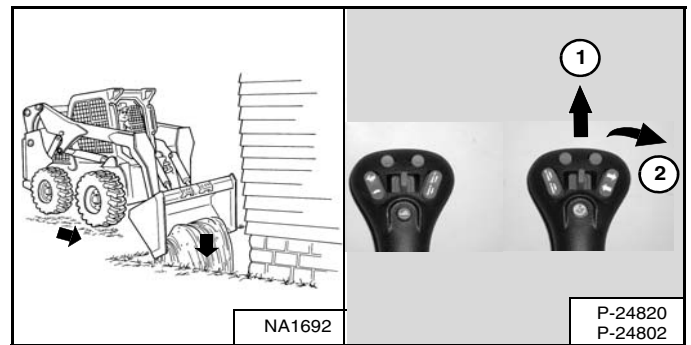

Lower the lift arms (Item 1) [Figure 170] and put the cutting edge of the bucket on the ground (Item 2) [Figure 170]. Drive forward to the edge of the hole to push the material into the hole.

Tilt the bucket forward (Item 2) [Figure 170] as soon as it is past the edge of the hole.

If necessary, raise the lift arms to empty the bucket.

TOWING THE LOADER

Procedure

Because of the design of the loader, there is not a recommended towing procedure.

- The loader can be lifted onto a transport vehicle.
- The loader can be skidded a short distance to move for service (EXAMPLE: Move onto a transport vehicle.) without damage to the hydrostatic system. (The tyres will not turn.) There might be slight wear to the tyres when the loader is skidded.

The towing chain (or cable) must be rated at 1.5 times the weight of the loader. (See Performance on Page 202.)

LIFTING THE LOADER

Single-Point Lift

! WARNING

AVOID INJURY OR DEATH

- Before lifting, check fasteners on single point lift and operator cab.
- Assemble front cab fasteners as shown in this manual.
- Never allow riders in the cab or bystanders within 5 m (15 ft) while lifting the machine.

W-2007-0910

The loader can be lifted with the Single-Point Lift which is available as a kit from your Bobcat loader dealer.

The Single-Point Lift, supplied by Bobcat, is designed to lift and support the Bobcat loader without affecting roll over and falling object protection features of the operator cab.

Figure 171

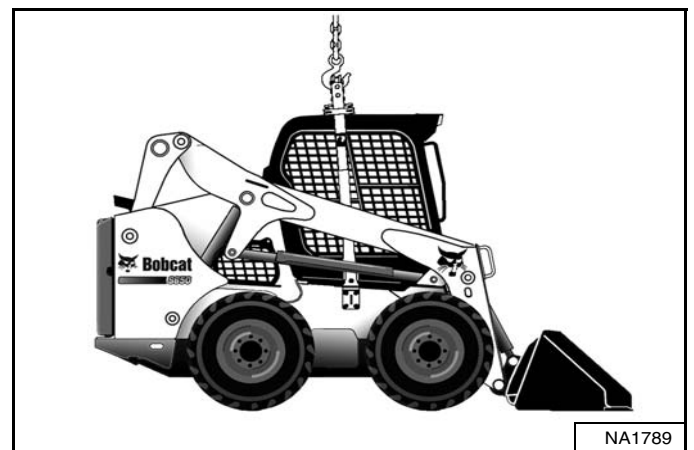

Attach lift to lift eye [Figure 171].

NOTE: Be sure the lifting equipment is of adequate size and capacity for the weight of the loader. (See Performance on Page 202.)

LIFTING THE LOADER (CONT'D)

Four-Point Lift



AVOID INJURY OR DEATH

- Before lifting, check fasteners on four point lift.
- Never allow riders in the cab or bystanders within 5 m (15 ft) while lifting the machine.

W-2160-0910

The loader can be lifted with the Four-Point Lift which is available as a kit from your Bobcat loader dealer.

Figure 172

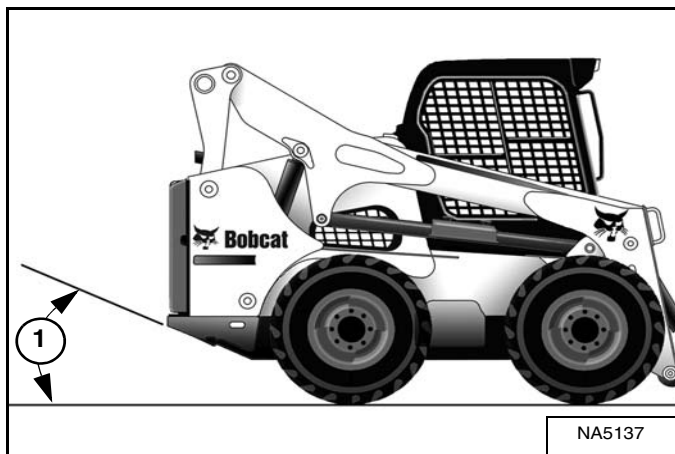

NOTE: The loader should be lifted as close to horizontal as possible, but at no time shall the angle of the suspended loader exceed the departure angle (Item 1) [Figure 172] provided in the specifications section. (See Machine Dimensions on Page 201.)

Figure 173

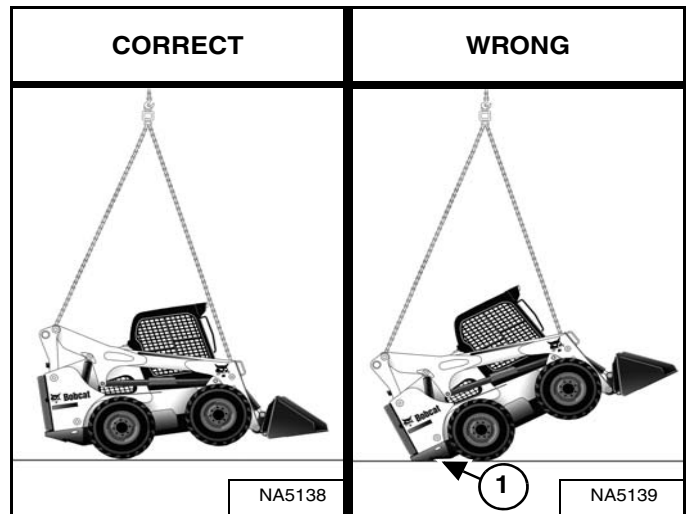

Attach cables or chains to lift eyes [Figure 173].

NOTE: Sling legs should not contact any part of the operator cab or lift arms to prevent damage.

NOTE: The required length of front and rear sling legs may or may not be equal depending on loader configuration. Departure angle (Item 1) [Figure 173] in this view has been exceeded, sling leg length must be adjusted to prevent this situation.

NOTE: Be sure the lifting equipment is of adequate size and capacity for the weight of the loader. (See Performance on Page 202.)

TRANSPORTING THE LOADER ON A TRAILER

Loading And Unloading



AVOID SERIOUS INJURY OR DEATH

Adequately designed ramps of sufficient strength are needed to support the weight of the machine when loading onto a transport vehicle. Wood ramps can break and cause personal injury.

W-2058-0807

Be sure the transport and towing vehicles are of adequate size and capacity for weight of loader. (See Performance on Page 202.)

Figure 174



A loader with an empty bucket or no attachment must be loaded backward onto the transport vehicle [Figure 174].

The rear of the trailer must be blocked or supported (Item 1) [Figure 174] when loading or unloading the loader to prevent the front end of the trailer from raising up.

Fastening

Figure 175

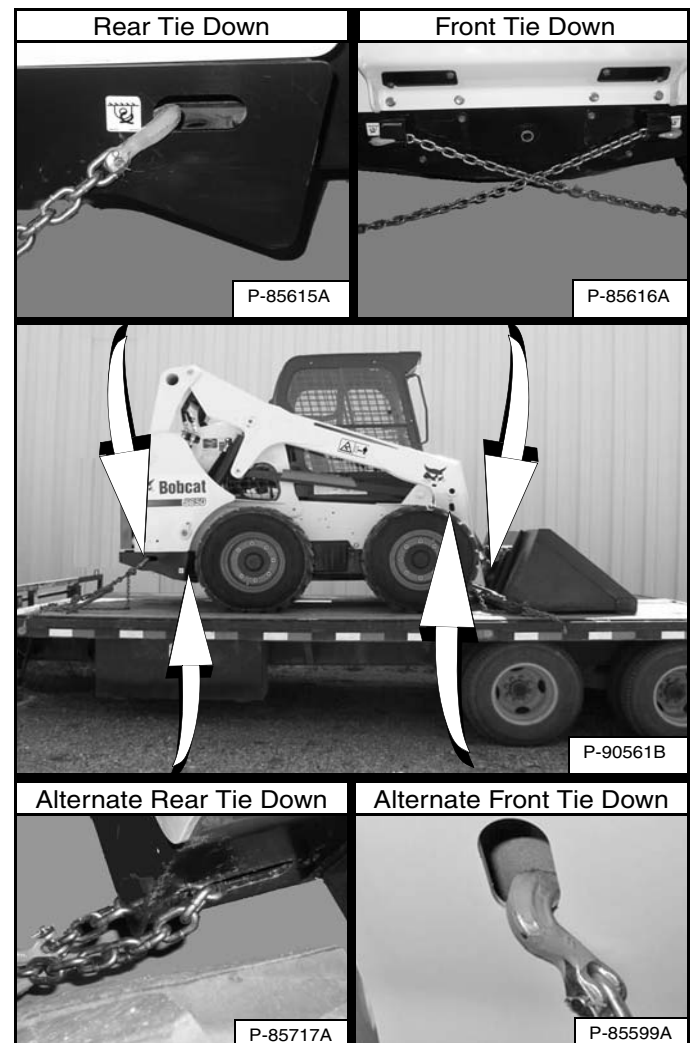

Use the following procedure to fasten the Bobcat loader to the transport vehicle to prevent the loader from moving during sudden stops or when going up or down slopes [Figure 175].

1. Lower the bucket or attachment to the floor.
2. Stop the engine.
3. Engage the parking brake.
4. Install chains at the front and rear loader tie down positions [Figure 175]. (Lift arms shown raised for clarity.)
5. Fasten each end of the chain to the transport vehicle.
6. Use chain binders to tighten the chains.



Bobcat®



PREVENTIVE MAINTENANCE

MAINTENANCE SAFETY 129

SERVICE SCHEDULE 131
 Chart 131
 Inspection Checkbook 132

BOBCAT INTERLOCK CONTROL SYSTEM (BICS™) 132
 Inspecting The BICS™ (Engine STOPPED - Key ON) 132
 Inspecting Deactivation Of The Auxiliary Hydraulics System (Engine STOPPED - Key ON)
 132
 Inspecting The Seat Bar Sensor (Engine RUNNING) 133
 Inspecting The Traction Lock (Engine RUNNING) 133
 Inspecting The Lift Arm Bypass Control 133
 Inspecting Deactivation Of Lift And Tilt Functions (ACS, AHC And SJC) 133

SEAT BAR RESTRAINT SYSTEM 134
 Description 134
 Inspecting 134
 Maintaining 135

SEAT BELT 136
 Inspection And Maintenance 136

LIFT ARM SUPPORT DEVICE 137
 Installing 137
 Removing 138

BACK-UP ALARM SYSTEM 139
 Description 139
 Inspecting 139
 Adjusting Switch Position 140

OPERATOR CAB 141
 Description 141
 Raising 141
 Lowering 142
 Cab Door Sensor 143

REAR DOOR (TAILGATE) 144
 Opening And Closing 144
 Adjusting 144

REAR GRILLE 145
 Removing 145
 Installing 145



HEATING, VENTILATION AND AIR CONDITIONING (HVAC)	146
Cleaning And Maintenance	146
Filters	146
Evaporator / Heater Coil	147
Condenser	148
Air Conditioning Lubrication	148
Troubleshooting	148
AIR CLEANER SERVICE	148
Replacing Filter Elements	148
FUEL SYSTEM	150
Fuel Specifications	150
Biodiesel Blend Fuel	150
Filling The Fuel Tank	151
Fuel Filter	152
Removing Air From The Fuel System	152
ENGINE LUBRICATION SYSTEM	153
Checking And Adding Engine Oil	153
Engine Oil Chart	153
Removing And Replacing Oil And Filter	154
ENGINE COOLING SYSTEM	155
Maintenance Platform	155
Cleaning	155
Checking Level	157
Removing And Replacing Coolant	157
ELECTRICAL SYSTEM	158
Description	158
Fuse And Relay Location / Identification	158
Battery Maintenance	161
Using A Booster Battery (Jump Starting)	162
Removing And Installing Battery	163
HYDRAULIC / HYDROSTATIC SYSTEM	164
Checking And Adding Fluid	164
Hydraulic / Hydrostatic Fluid Chart	164
Removing And Replacing Hydraulic Fluid	165
Removing And Replacing Hydraulic / Hydrostatic Filter	167
Removing And Replacing Hydraulic Charge Filter	168
Breather Cap	169
SPARK ARRESTER MUFFLER	170
Cleaning Procedure	170
TYRE MAINTENANCE	171
Wheel Nuts	171
Rotating	171
Mounting	171



FINAL DRIVE TRANSMISSION (CHAINCASE)	172
Checking And Adding Oil	172
Removing And Replacing Oil	172
ALTERNATOR BELT	173
Belt Adjustment	173
Belt Replacement	173
AIR CONDITIONING BELT	175
Belt Adjustment	175
Belt Replacement	175
DRIVE BELT	176
Belt Adjustment	176
Stop Adjustment	176
Belt Replacement	176
LUBRICATING THE LOADER	178
Lubrication Locations	178
PIVOT PINS	181
Inspection And Maintenance	181
BOB-TACH (HAND LEVER)	182
Inspection And Maintenance	182
BOB-TACH (POWER)	183
Inspection And Maintenance	183
LOADER STORAGE AND RETURN TO SERVICE	184
Storage	184
Return To Service	184



Bobcat®

MAINTENANCE SAFETY

WARNING

Instructions are necessary before operating or servicing machine. Read and understand the Operation & Maintenance Manual, Operator's Handbook and signs (decals) on machine. Follow warnings and instructions in the manuals when making repairs, adjustments or servicing. Check for correct function after adjustments, repairs or service. Untrained operators and failure to follow instructions can cause injury or death.

W-2003-0807

Safety Alert Symbol: This symbol with a warning statement, means: "Warning, be alert! Your safety is involved!" Carefully read the message that follows.

CORRECT

P-90216

Never service the Bobcat Skid-Steer Loader without instructions.

CORRECT

NA1694

Use the correct procedure to lift or lower operator cab.

CORRECT

NA1693

Cleaning and maintenance are required daily.

WRONG

NA1674

Have good ventilation when welding or grinding painted parts.

Wear dust mask when grinding painted parts. Toxic dust and gas can be produced.

Avoid exhaust fume leaks which can kill without warning. Exhaust system must be tightly sealed.

WRONG

NA1695

Disconnecting or loosening any hydraulic tubeline, hose, fitting, component or a part failure can cause lift arms to drop. Do not go under lift arms when raised unless supported by an approved lift arm support device. Replace it if damaged.

WRONG

NA1680

Never work on loader with lift arms up unless lift arms are held by an approved lift arm support device. Replace if damaged.

Never modify equipment or add attachments not approved by Bobcat Company.

WRONG

NA1682

Stop, cool and clean engine of flammable materials before checking fluids.

Never service or adjust loader with the engine running unless instructed to do so in the manual.

Avoid contact with leaking hydraulic fluid or diesel fuel under pressure. It can penetrate the skin or eyes.

Never fill fuel tank with engine running, while smoking or when near open flame.

WRONG

NA1683

Keep body, jewelry and clothing away from moving parts, electrical contact, hot parts and exhaust.

Wear eye protection to guard from battery acid, compressed springs, fluids under pressure and flying debris when engines are running or tools are used. Use eye protection approved for type of welding.

Keep rear door closed except for service. Close and latch door before operating the loader.

WRONG

B-6589

Lead-acid batteries produce flammable and explosive gases.

Keep arcs, sparks, flames and lighted tobacco away from batteries.

Batteries contain acid which burns eyes or skin on contact.

Wear protective clothing. If acid contacts body, flush well with water. For eye contact flush well and get immediate medical attention.

Maintenance procedures which are given in the Operation & Maintenance Manual can be performed by the owner/operator without any specific technical training. Maintenance procedures which are **not** in the Operation & Maintenance Manual must be performed **ONLY BY QUALIFIED BOBCAT SERVICE PERSONNEL**. Always use genuine Bobcat replacement parts. The Service Safety Training Course is available from your Bobcat dealer.

MSW39-0609



Bobcat®



SERVICE SCHEDULE

Chart

Maintenance work must be done at regular intervals. Failure to do so will result in excessive wear and early failures. The service schedule is a guide for correct maintenance of the Bobcat loader.

<b style="font-size: 24px; margin-left: 10px;">WARNING	<p>Instructions are necessary before operating or servicing machine. Read and understand the Operation & Maintenance Manual, Operator's Handbook and signs (decals) on machine. Follow warnings and instructions in the manuals when making repairs, adjustments or servicing. Check for correct function after adjustments, repairs or service. Untrained operators and failure to follow instructions can cause injury or death.</p> <p style="text-align: right; font-size: 10px;">W-2003-0807</p>
--	--

SERVICE SCHEDULE		HOURS					
ITEM	SERVICE REQUIRED	8-10	50	100	[5] 250	[5] 500	[5] 1000
Engine Oil	Check the oil level and add as needed. Do not overfill.						
Engine Air Filter and Air System	Check display panel. Service only when required. Check for leaks and damaged components.						
Engine Cooling System	Clean debris from oil cooler, radiator and grille. Check coolant level COLD and add premixed coolant as needed.						
Fuel Filter	Remove the trapped water.						
Lift Arms, Lift Links, Cylinders, Bob-Tach, Pivot Pins, Wedges	Lubricate with multipurpose lithium based grease.						
Tyres	Check for damaged tyres and correct air pressure. Inflate to MAXIMUM pressure shown on the sidewall of the tyre.						
Seat Bar, Control Interlocks, Seat Belt, Seat Belt Retractors	Check the condition of seat belt. Clean or replace seat belt retractors as needed. Check the seat bar and control interlocks for correct operation. Clean dirt and debris from moving parts.						
Bobcat Interlock Control Systems (BICS™)	Check for correct function. Lift and Tilt functions MUST NOT operate with seat bar raised. See details in this Manual.						
Front Horn	Check for proper function.						
Safety Signs and Safety Treads	Check for damaged signs (decals) and safety treads. Replace any signs or safety treads that are damaged or worn.						
Operator Cab	Check the fastening bolts, washers and nuts. Check the condition of the cab.						
Indicators and Lights	Check for correct operation of all indicators and lights.						
Heater and A/C Filters (If Equipped)	Clean or replace filters as needed.						
Hydraulic Fluid	Check fluid level and add as needed.						
Hydraulic Hoses and Tubelines	Check for damage and leaks. Repair or replace as needed.						
Final Drive Trans. (Chaincase),	Check fluid level and add as needed.						
Parking Brake, Foot Pedals, Hand Controls and Steering Levers or Joysticks	Check for correct operation. Repair or adjust as needed.						
Wheel Nuts	Check for loose wheel nuts and tighten to correct torque. (See TYRE MAINTENANCE in this manual.)	[1]					
Spark Arrester Muffler	Clean the spark chamber.						
Battery	Check cables, connections and electrolyte level. Add distilled water as needed.						
Fuel Filter	Replace filter element.						
Engine / Hydro. Drive Belt	Check for wear or damage. Check idler arm stop.		[2]				
Drive Belts (Alternator, air conditioning, water pump)	Check condition. Replace as needed.						
Bobcat Interlock Control System (BICS™)	Check the function of the lift arm bypass control.						
Engine Oil and Filter	Replace oil and filter.		[2]	[3]			
Hydraulic Charge Filter, Hydraulic Reservoir Breather	Replace the charge filter and the reservoir breather.						
Hydraulic / Hydrostatic Filter	Replace the hydraulic / hydrostatic filter.						
Final Drive Trans. (Chaincase)	Replace the fluid.						
Hydraulic Reservoir	Replace the fluid.						
Engine Valves	Adjust the engine valves.					[4]	
Coolant	Replace the coolant						Every 2 years

- [1] Check every 8 - 10 hours for the first 24 hours, then at 50 hour intervals.
- [2] Perform at first 50 hours, then as scheduled.
- [3] Change oil and filter every 100 hours when operating under severe conditions.
- [4] Perform at first 500 hours, then as scheduled.
- [5] Or every 12 months.

NOTE: The Inspection Checklist can be ordered for you by your local dealer. Part number 4420300.

SERVICE SCHEDULE (CONT'D)

Inspection Checkbook

Regularly scheduled maintenance is essential to continuous operation and operating safety. The life expectancy of your machine depends on proper and meticulous care.

The Inspection Checkbook contains the following information:

- Doosan Trading Limited Warranty Conditions
- Protection Plus Extended Warranty Conditions
- General Parts Policy
- General Information
- First Inspection
- Scheduled Services
- Identification
- Authorised Identification
- Lubricants and Fluids Table
- Service Parts Chart

Your local dealer can order the Inspection Checkbook.
Part number: 4420300.

BOBCAT INTERLOCK CONTROL SYSTEM (BICSTM)

Inspecting The BICSTM (Engine STOPPED - Key ON)

Figure 176

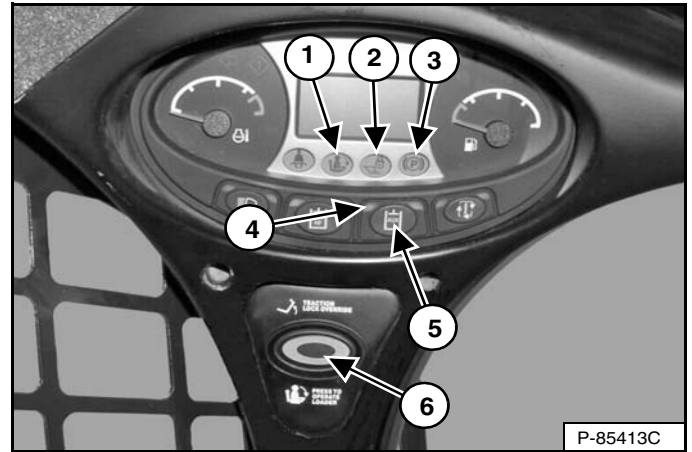

1. Sit in operator's seat. Turn key switch to RUN or press RUN button. Lower seat bar and disengage parking brake. Press the PRESS TO OPERATE LOADER button (Item 6). Two BICSTM lights (Items 1 and 2) [Figure 176] [SEAT BAR AND LIFT & TILT VALVE] on left instrument panel must be OFF. The PRESS TO OPERATE LOADER button will light.
2. Raise seat bar fully. All three BICSTM lights (Items 1, 2 and 3) [Figure 176] [SEAT BAR, LIFT & TILT VALVE and PARKING BRAKE] on left instrument panel must be ON. The PRESS TO OPERATE LOADER button light will turn OFF.

Inspecting Deactivation Of The Auxiliary Hydraulics System (Engine STOPPED - Key ON)

3. Sit in operator's seat, lower seat bar and press the PRESS TO OPERATE LOADER button (Item 6). Press the auxiliary hydraulics button (Item 5). The auxiliary hydraulics light will be ON (Item 4) [Figure 176]. Raise the seat bar. The light must be OFF.



**BOBCAT INTERLOCK CONTROL SYSTEM (BICS™)
(CONT'D)**

Inspecting The Seat Bar Sensor (Engine RUNNING)

4. Sit in operator's seat, lower seat bar, engage parking brake and fasten seat belt.
5. Start engine and operate at low idle. Press the PRESS TO OPERATE LOADER button. While raising the lift arms, raise the seat bar fully. The lift arms must stop. Repeat using the tilt function.

Inspecting The Traction Lock (Engine RUNNING)

6. Fasten seat belt, disengage parking brake, press the PRESS TO OPERATE LOADER button and raise seat bar fully. Move steering levers or joystick(s) slowly forward and backward. The TRACTION lock must be engaged. Lower the seat bar. Press the PRESS TO OPERATE LOADER button.
7. Engage parking brake and move steering levers or joystick(s) slowly forward and backward. The TRACTION lock must be engaged.

NOTE: The PARKING BRAKE light on the left instrument panel will remain ON until the engine is started, the PRESS TO OPERATE LOADER button is pressed and the parking brake is disengaged.

Inspecting The Lift Arm Bypass Control

8. Raise the lift arms 2 m (6 ft) off the ground. Stop engine. Turn lift arm bypass control knob 90° clockwise. Pull up and hold lift arm bypass control knob until lift arms slowly lower.

**Inspecting Deactivation Of Lift And Tilt Functions
(ACS, AHC And SJC)**

9. Sit in operator's seat and fasten seat belt. Lower seat bar, start engine and press the PRESS TO OPERATE LOADER button.
10. Raise lift arms about 2 m (6 ft) off the ground.
11. Turn key switch OFF or press STOP button and wait for the engine to come to a complete stop.
12. Turn key switch ON or press RUN button. Press the PRESS TO OPERATE LOADER button, move the control (foot pedal, hand control or joystick) to lower the lift arms. Lift arms must not lower.
13. Move the control (foot pedal, hand control or joystick) to tilt the bucket (or attachment) forward. The bucket (or attachment) must not tilt forward.



AVOID INJURY OR DEATH

The Bobcat Interlock Control System (BICS) must deactivate the lift, tilt and traction drive functions. If it does not, contact your dealer for service. DO NOT modify the system.

W-2151-0394



SEAT BAR RESTRAINT SYSTEM

Description

The Seat Bar Restraint System has a pivoting seat bar with armrests.

The operator controls the use of the seat bar. The seat bar in the down position helps to keep the operator in the seat.

Models with Standard Controls have hydraulic valve spool interlocks for the lift and tilt functions. The spool interlocks require the operator to lower the seat bar in order to operate the foot pedal controls.

When the seat bar is down, the engine is running, the PRESS TO OPERATE LOADER button is activated, and the brake is released, the lift, tilt, and traction drive functions can be operated.

When the seat bar is up, the lift and tilt control pedals are locked when returned to the NEUTRAL position.

Models with Advanced Control System (ACS) have mechanical interlocks for the handles and pedals. The interlocks for the handles and pedals require the operator to lower the seat bar in order to operate the selected controls.

When the seat bar is down, the engine is running, the PRESS TO OPERATE LOADER button is activated, and the brake is released, the lift, tilt, and traction drive functions can be operated.

When the seat bar is up, the handles and pedals are locked when returned to the NEUTRAL position.

Models with Advanced Hand Controls (AHC) have mechanical interlocks for the handles. The interlocks for the handles require the operator to lower the seat bar in order to operate the controls.

When the seat bar is down, the engine is running, the PRESS TO OPERATE LOADER button is activated, and the brake is released, the lift, tilt, and traction drive functions can be operated.

When the seat bar is up, the handles are locked when returned to the NEUTRAL position.

Models with Selectable Joystick Controls (SJC) have electrical deactivation of lift and tilt functions. Activation of functions require the operator to lower the seat bar.

When the seat bar is down, the engine is running, the PRESS TO OPERATE LOADER button is activated, and the brake is released, the lift, tilt, and traction drive functions can be operated.

When the seat bar is up, the lift and tilt functions are deactivated even though the joysticks do not mechanically lock.

Inspecting

Sit in the seat and fasten the seat belt. Engage the parking brake. Pull the seat bar all the way down. Start the engine. Press the PRESS TO OPERATE LOADER button.

Operate the hydraulic controls to check that both the lift and tilt functions operate correctly. Raise the lift arms until the attachment is about 600 mm (2 ft) off the ground.

Raise the seat bar. Move the hydraulic controls. Pedals and handles (if equipped) must be firmly locked in the NEUTRAL position (except joysticks). There must be no motion of the lift arms or tilt (attachment) when the controls are moved.

Lower the seat bar, press the PRESS TO OPERATE LOADER button and lower the lift arms. Operate the lift control. While the lift arms are going up, raise the seat bar. The lift arms must stop.

Lower the seat bar, press the PRESS TO OPERATE LOADER button, lower the lift arms and put the attachment flat on the ground. Stop the engine. Raise the seat bar. Operate the foot pedals and handles (if equipped) to be sure they are firmly locked in the NEUTRAL position (except joysticks).

SEAT BAR RESTRAINT SYSTEM (CONT'D)

Maintaining

See the SERVICE SCHEDULE for correct service interval. (See SERVICE SCHEDULE on Page 131.)

Figure 177

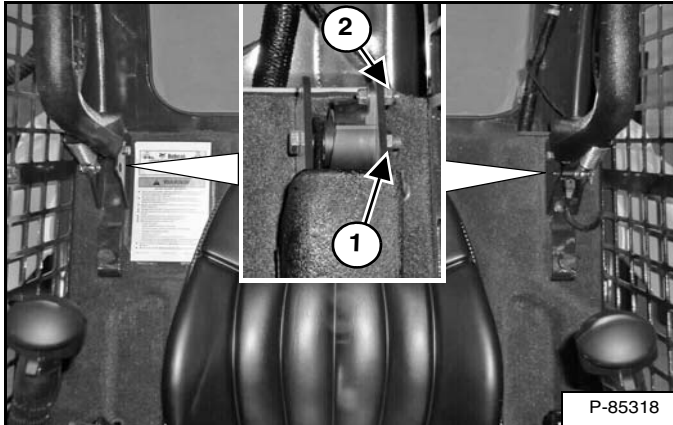

Use compressed air to clean any debris or dirt from the pivot parts. Do not lubricate. Inspect all mounting hardware. The correct hinge bolt (Item 1) torque is 34 - 38 N•m (25 - 28 ft-lb). The seat bar sensor nut (left side only) (Item 2) [Figure 177] torque is 6 - 8 N•m (50 - 70 in-lb).

If the seat bar system does not function correctly, replace parts that are worn or damaged. Use only genuine Bobcat replacement parts.

WARNING

The seat bar system must deactivate the lift and tilt control functions when the seat bar is up. See your Bobcat dealer for service if hydraulic controls do not deactivate.

W-2465-111

SEAT BELT

Inspection And Maintenance

! WARNING

Failure to properly inspect and maintain the seat belt can cause lack of operator restraint resulting in serious injury or death.

W-2466-0703

Check the seat belt daily for correct function.

Inspect the seat belt system thoroughly at least once each year or more often if the machine is exposed to severe environmental conditions or applications.

Any seat belt system that shows cuts, fraying, extreme or unusual wear, significant discolourations due to ultraviolet UV exposure, dusty / dirty conditions, abrasion to the seat belt webbing, or damage to the buckle, latch plate, retractor (if equipped), hardware or any other obvious problem should be replaced immediately.

The items below are referenced in **[Figure 178]**.

1. Check the webbing. If the system is equipped with a retractor, pull the webbing completely out and inspect the full length of the webbing. Look for cuts, wear, fraying, dirt and stiffness.
2. Check the buckle and latch for correct operation. Make sure latch plate is not excessively worn, deformed or buckle is not damaged or casing broken.
3. Check the retractor web storage device (if equipped) by extending webbing to determine if it looks correct and that it spools out and retracts webbing correctly.
4. Check webbing in areas exposed to ultraviolet (UV) rays from the sun or extreme dust or dirt. If the original colour of the webbing in these areas is extremely faded and / or the webbing is packed with dirt, the webbing strength may have deteriorated.

See your Bobcat dealer for seat belt system replacement parts for your machine.

Figure 178

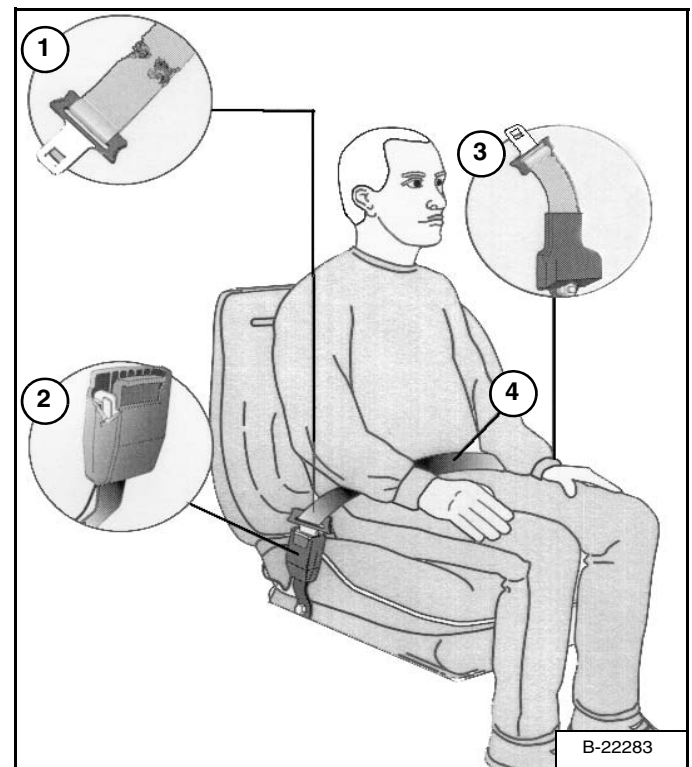

LIFT ARM SUPPORT DEVICE

Installing

! WARNING

Never work on a machine with the lift arms up unless the lift arms are secured by an approved lift arm support device. Failure to use an approved lift arm support device can allow the lift arms or attachment to fall and cause injury or death.

Service lift arm support device if damaged or if parts are missing. Using a damaged lift arm support or with missing parts can cause lift arms to drop causing injury or death.

W-2572-0407

! DANGER

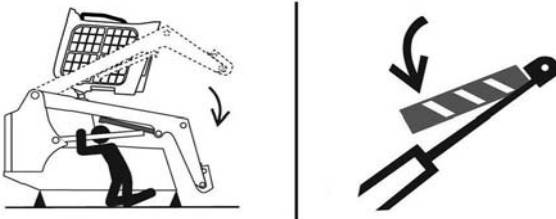

P-90328

AVOID DEATH

- Disconnecting or loosening any hydraulic tubeline, hose, fitting, component or a part failure can cause lift arms to drop.
- Keep out of this area when lift arms are raised unless supported by an approved lift arm support. Replace if damaged.

D-1009-0409

Remove attachment from the loader. (See Installing And Removing The Attachment (Hand Lever Bob-Tach) on Page 103.) **OR** (See Installing And Removing The Attachment (Power Bob-Tach) on Page 105.)

Figure 179

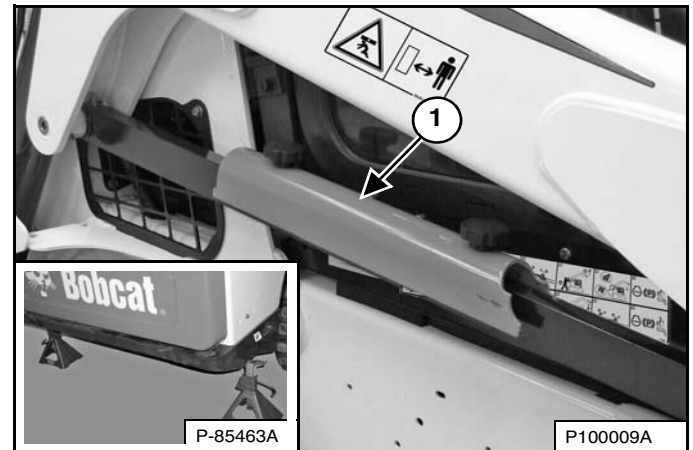

Put jackstands under the rear corners of the loader frame (Inset) [Figure 179].

Remove the lift arm support device (Item 1) [Figure 179] from the storage position.

The operator must stay in the operator seat with the seat belt fastened and the seat bar lowered until the lift arm support device is installed.

Start the engine and raise the lift arms all the way up.

Figure 180



Have a second person install the lift arm support device over the rod of one of the lift cylinders [Figure 180].

The lift arm support device must be tight against the cylinder rod.

LIFT ARM SUPPORT DEVICE (CONT'D)

Installing (Cont'd)

Figure 181



Lower the lift arms slowly until the lift arm support device is held between the lift arms and the lift cylinder [Figure 181]. The tabs of the lift arm support device must go past the end of the cylinder (Inset) [Figure 181].

Removing

The operator must be in the operator's seat, with the seat belt fastened and seat bar lowered, until the lift arm support device is removed and the lift arms are lowered all the way.

Start the engine and raise the lift arms all the way up.

Have a second person remove the lift arm support device.

Lower the lift arms all the way and stop the engine.

Return the lift arm support device to the storage position and secure with clamping knobs.

Remove the jackstands.

BACK-UP ALARM SYSTEM

This machine may be equipped with a Back-up Alarm.

Description

The back-up alarm will sound when the operator moves both steering levers or joystick(s) into the reverse position. Slight movement of the steering levers into the reverse position is required with hydrostatic transmissions, before the back-up alarm will sound.

Inspecting

Figure 182

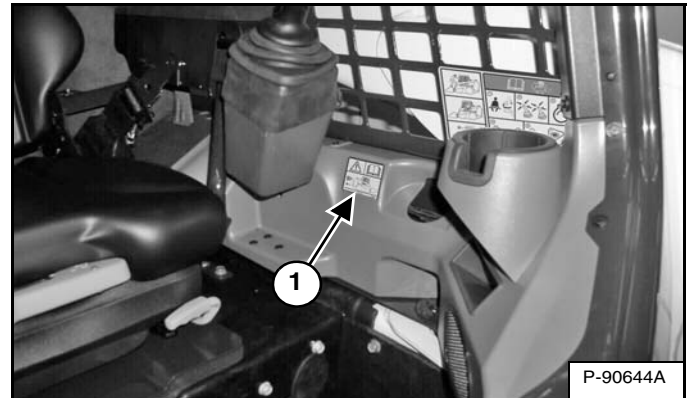

Inspect for damaged or missing back-up alarm decal (Item 1) [Figure 182]. Replace if required.

Sit in the seat and fasten the seat belt. Engage the parking brake. Pull the seat bar all the way down. Start the engine. Press the PRESS TO OPERATE LOADER button. Disengage the parking brake.

Move both steering levers or joystick(s) into the reverse position. The back-up alarm must sound when all wheels or both tracks are moving in reverse.

The back-up alarm is located on the inside of the rear door.

Figure 183

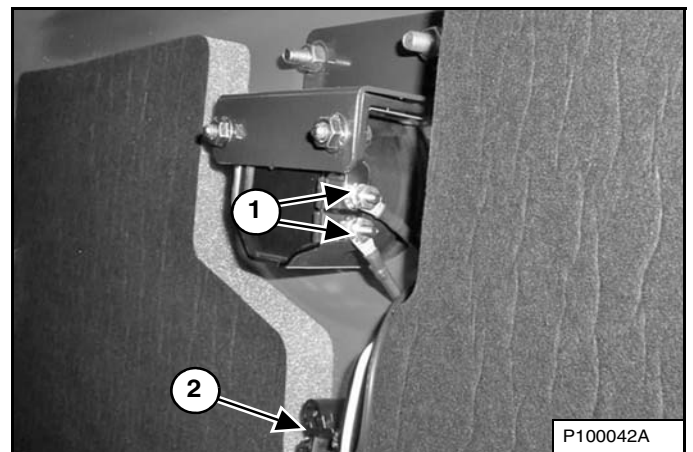

Inspect the back-up alarm electrical connections (Item 1) [Figure 183], wire harness (Item 2) [Figure 183] and back-up alarm switches (if equipped) (Item 1) [Figure 184] for tightness and damage. Repair or replace any damaged components.

If the back-up alarm switches require adjustment, (See Adjusting Switch Position on Page 140.)

BACK-UP ALARM SYSTEM (CONT'D)

Adjusting Switch Position

NOTE: Joystick equipped machines do not have back-up alarm switches and cannot be adjusted. See your Bobcat dealer for service if your back-up alarm does not sound.

Standard Controls, ACS And AHC (If Equipped)

Stop the engine and raise the operator cab. (See Raising on Page 141.)

Place the steering levers in the neutral position.

Figure 184

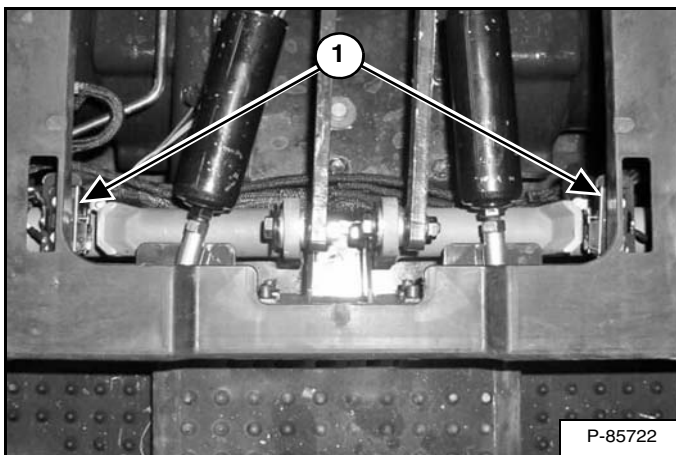

The back-up alarm switches (Item 1) [Figure 184] are located alongside the steering bellcranks. Both switches must be adjusted properly for the back-up alarm to operate correctly.

Figure 185

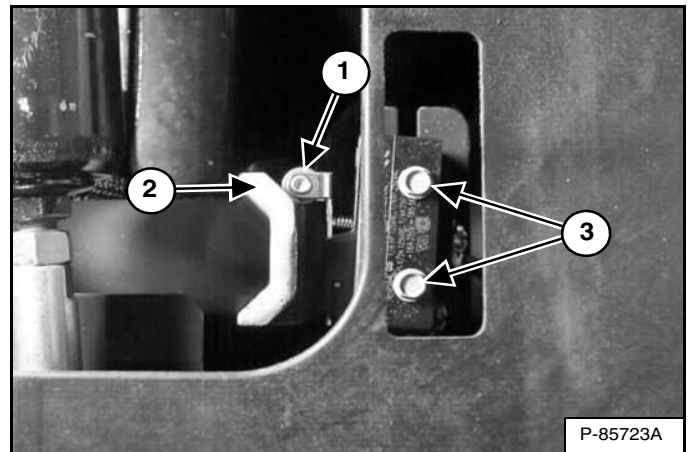

Loosen the screws (Item 3) [Figure 185] securing the back-up alarm switch. (Left side shown)

Position the back-up alarm switch so that the roller (Item 1) just makes contact with the bellcrank (Item 2) [Figure 185] without compressing the switch spring.

Torque the screws (Item 3) [Figure 185] securing the switch to the bracket to 1,6 - 2,1 N•m (14 - 19 in-lb).

Repeat adjustment procedure for the other switch.

Lower the operator cab. (See Lowering on Page 142.)

Inspect back-up alarm system for proper function. (See Inspecting on Page 139.)

OPERATOR CAB

Description

The Bobcat loader has an operator cab (ROPS and FOPS) as standard equipment to protect the operator from rollover and falling objects. The seat belt must be worn for rollover protection.

Check the ROPS / FOPS cab, mounting and hardware for damage. Never modify the ROPS / FOPS cab. Replace the cab and hardware if damaged. See your Bobcat dealer for parts.

ROPS / FOPS - Roll Over Protective Structure per ISO 3471, and Falling Object Protective Structure per ISO 3449, Level I. Level II is available.

Level I

Protection from falling bricks, small concrete blocks, and hand tools encountered in operations such as motorway maintenance, landscaping, and other construction sites.

Level II

Protection from falling trees, rocks: for machines involved in site clearing, overhead demolition or forestry.



Never modify operator cab by welding, grinding, drilling holes or adding attachments unless instructed to do so by Bobcat Company. Changes to the cab can cause loss of operator protection from rollover and falling objects, and result in injury or death.

W-2069-0200

Raising

Always stop the engine before raising or lowering the operator cab.

Stop the loader on a level surface. Lower the lift arms. If the lift arms must be up while raising the operator cab, install the lift arm support device. (See LIFT ARM SUPPORT DEVICE on Page 137.)

Figure 186



Install jackstands under the rear of the loader frame [Figure 186].

Figure 187

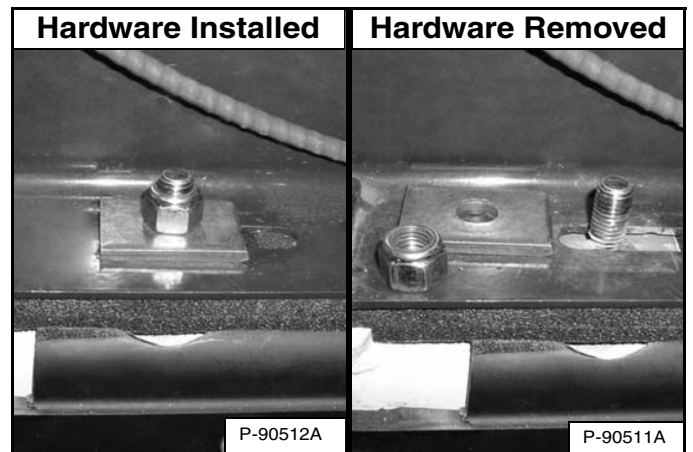

Remove the nuts and washers [Figure 187] (both sides) at the front corners of the operator cab.



UNEXPECTED LOADER, LIFT ARM OR ATTACHMENT MOVEMENT CAUSED BY CAB CONTACT WITH CONTROLS CAN CAUSE SERIOUS INJURY OR DEATH

- **STOP ENGINE before raising or lowering cab.**

W-2758-0908

NOTE: On some machines, the operator cab frame could contact the steering levers while raising or lowering the operator cab. The engine MUST be stopped before raising or lowering the operator cab.

OPERATOR CAB (CONT'D)

Raising (Cont'd)

Figure 188



Lift on the grab handles and bottom of the operator cab [Figure 188] slowly until the operator cab is all the way up and the latching mechanism engages.

Lowering

Always stop the engine before raising or lowering the operator cab.

NOTE: Always use the grab handles to lower the operator cab.

Figure 189



Pull down on the bottom of the operator cab until it stops at the latching mechanism [Figure 189].

NOTE: The weight of the operator cab increases when equipped with options and accessories such as cab door, heater, air conditioning, etc. In these cases, the operator cab may need to be raised slightly from the latch to be able to release the latch.



UNEXPECTED LOADER, LIFT ARM OR ATTACHMENT MOVEMENT CAUSED BY CAB CONTACT WITH CONTROLS CAN CAUSE SERIOUS INJURY OR DEATH

- **STOP ENGINE** before raising or lowering cab.

W-2758-0908

NOTE: On some machines, the operator cab frame could contact the steering levers while raising or lowering the operator cab. The engine **MUST** be stopped before raising or lowering the operator cab.

Support the operator cab and release the latching mechanism (Inset) [Figure 189]. Remove your hand from the latch mechanism when the operator cab is past the latch stop. Use both hands to lower the operator cab all the way down.



PINCH POINT CAN CAUSE INJURY
Remove your hand from the latching mechanism when the cab is past the latch stop.

W-2469-0803

Figure 190

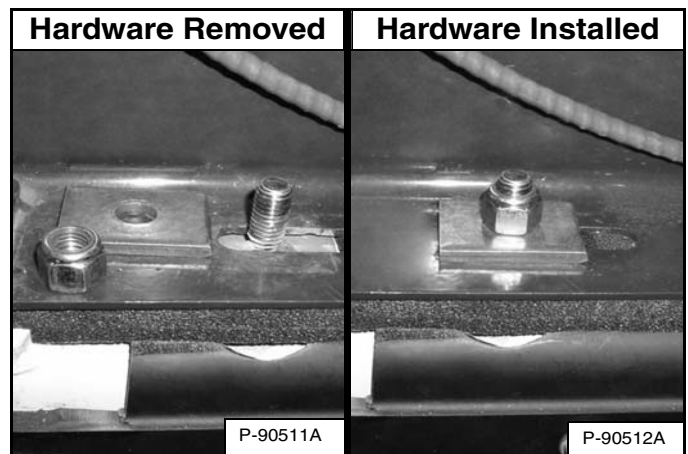

Install the washers and nuts (both sides) [Figure 190].

Tighten the nuts to 54 - 61 N•m (40 - 45 ft-lb) torque.

OPERATOR CAB (CONT'D)

Cab Door Sensor

This machine may be equipped with a Cab Door Sensor.

Figure 191

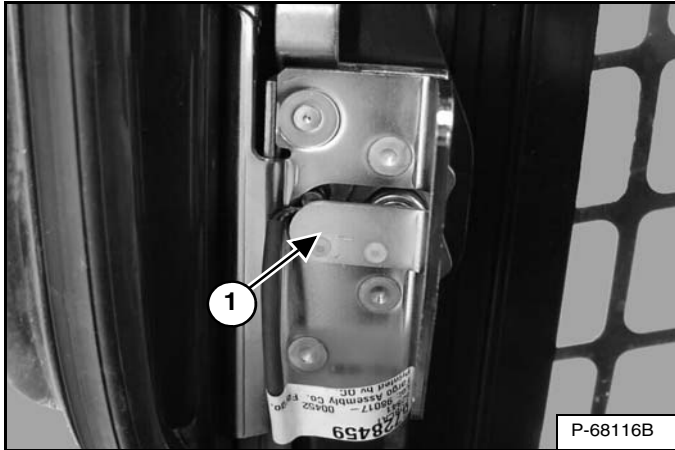

The cab door has a sensor (Item 1) [Figure 191] installed which deactivates the lift and tilt valves when the door is open.

Figure 192

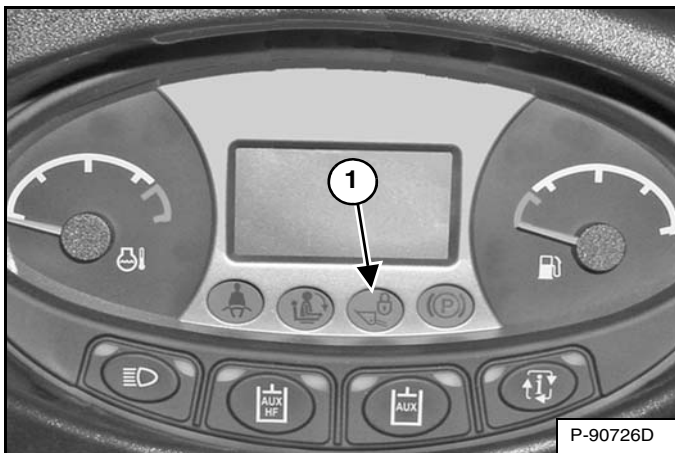

The LIFT AND TILT VALVE light (Item 1) [Figure 192] will be OFF when the door is closed, the key switch is turned to RUN or the RUN button is pressed, the seat bar is lowered and the PRESS TO OPERATE LOADER button is pressed.

Figure 193



The LIFT AND TILT VALVE light (Item 1) [Figure 192] will be ON when the door is open, the key switch is turned to RUN or the RUN button is pressed, the seat bar is lowered and the PRESS TO OPERATE LOADER button is pressed.

[DOOR] will appear in the data display [Figure 193].

REAR DOOR (TAILGATE)

Opening And Closing

Figure 194

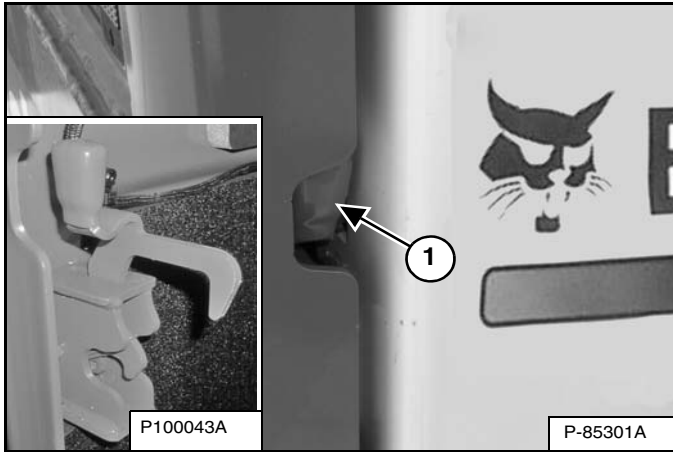

Reach into the slot on the right side of the rear door and pull the latch handle (Item 1) [Figure 194].

Pull the rear door open.

Figure 195

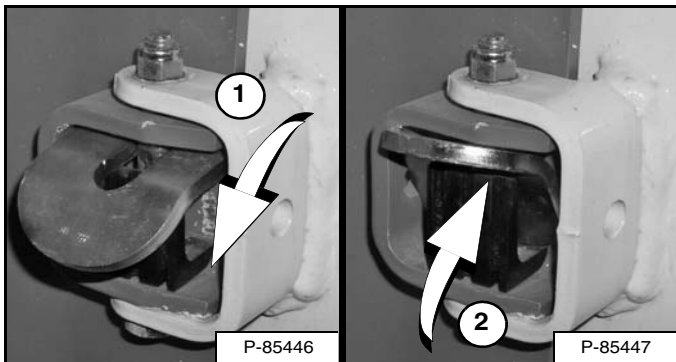

The rear door is equipped with a door stop feature on the top hinge.

Move the door stop into the engaged position (Item 1) [Figure 195] to hold the door open.

Move the door stop up (Item 2) [Figure 195] to disengage the door stop and allow the door to close.

Close the rear door.

! WARNING

Keep the rear door closed when operating the machine. Failure to do so could seriously injure a bystander.

W-2020-1285

Adjusting

Figure 196

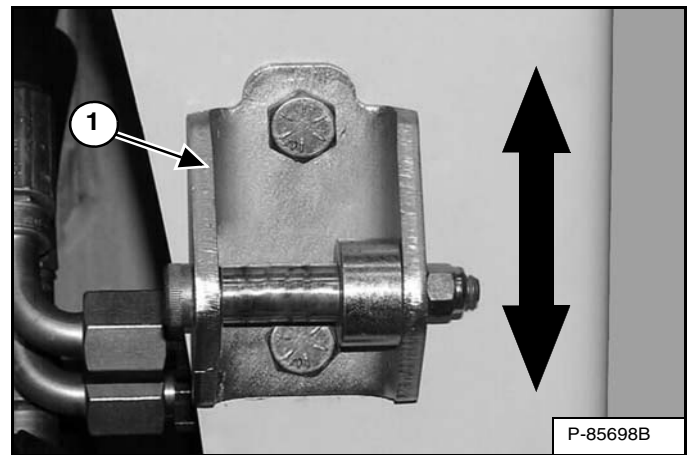

The door latch (Item 1) [Figure 196] can be adjusted up or down for alignment with the door latch mechanism.

Close the rear door before operating the loader.

REAR GRILLE

Removing

Figure 197

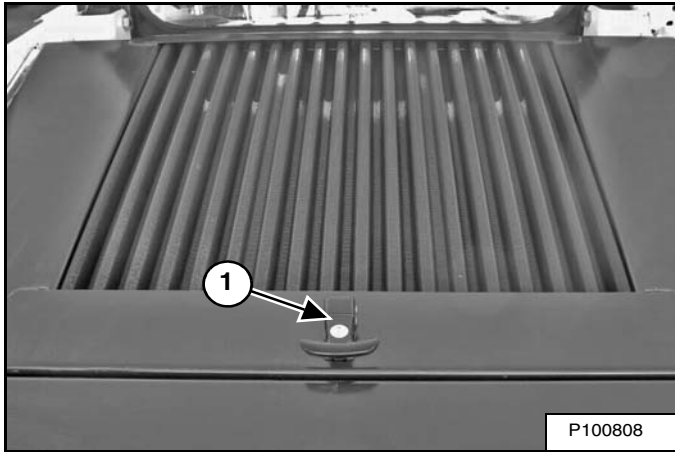

Flip the lockable handle (Item 1) [Figure 197] up and turn the handle 90° anticlockwise. Lift and pull the rear grille backward to remove from the loader.

Figure 198

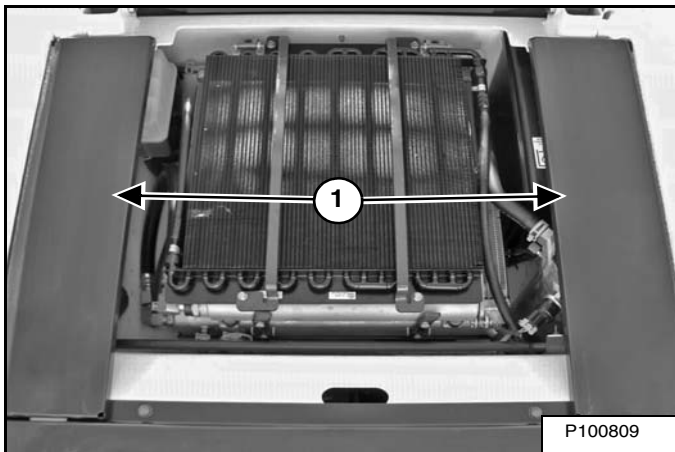

Lift and remove the two side covers (Item 1) [Figure 198].

Installing

Figure 199



Align the tabs of the two side covers into the slots in the loader frame and lower [Figure 199].

Figure 200

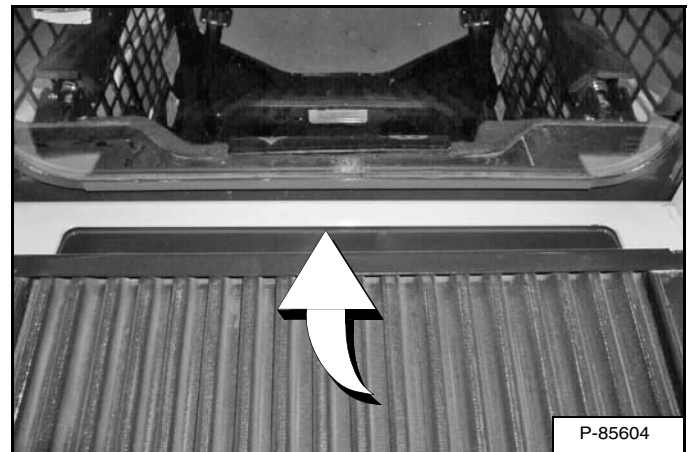

Align the edge of the rear grille under the loader frame and slide rear grille in while lowering [Figure 200].

Turn the lockable handle 90° clockwise and fold the handle down.

HEATING, VENTILATION AND AIR CONDITIONING (HVAC)

This machine may be equipped with a Heating System or HVAC.

Cleaning And Maintenance

The heating and HVAC systems require regular inspection and maintenance. (See SERVICE SCHEDULE on Page 131.)

Filters

Fresh Air Filters

Figure 201

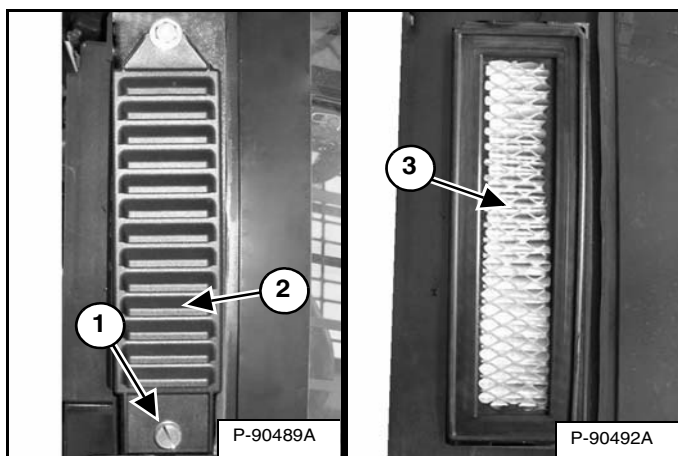

The fresh air filters are located behind the side windows outside the operator cab. (Right side shown) Remove the retaining screw (Item 1) and filter cover (Item 2) [Figure 201].

Shake the filter (Item 3) [Figure 201] or use low pressure air to remove dirt. This can be done several times before replacement is required. Install the filter, filter cover and retaining screw.

Recirculation Filter (Earlier Models)

Figure 202

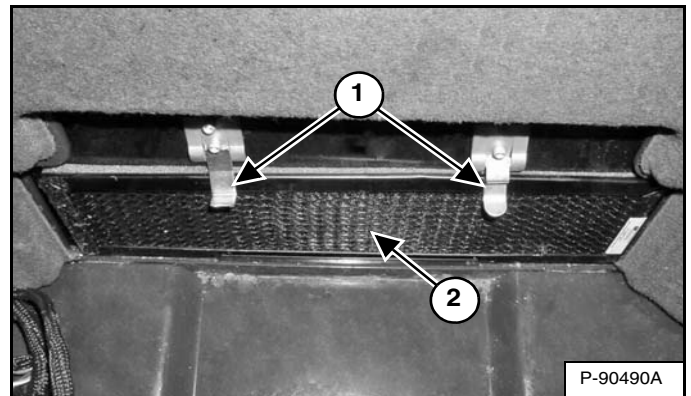

The recirculation filter is located behind the operator's seat inside the operator cab. Flip the clamps (Item 1) holding the filter up and remove the filter (Item 2) [Figure 202].

Shake the filter or use a vacuum to clean. This can be done several times before replacement is required.

Install the filter into the opening and flip the clamps down to hold the filter in place.

Recirculation Filter (Later Models)

Figure 203

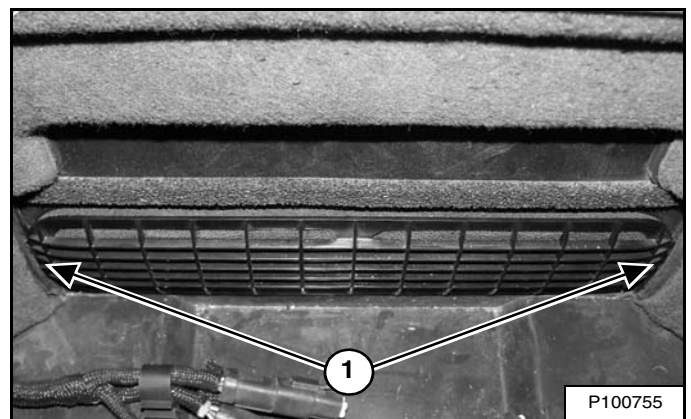

The recirculation filter is located behind the operator's seat inside the operator cab. The filter cover is held in place with three clips. Pull the cover at each end (Item 1) [Figure 203] to remove.

Rinse the filter elements with water or use a vacuum to clean. Do not use solvents.

Line up the clips on the filter cover with the slots provided and push the cover into place.

HEATING, VENTILATION AND AIR CONDITIONING (HVAC) (CONT'D)

Evaporator / Heater Coil

Earlier Models

Raise the operator cab. (See Raising on Page 141.)

Figure 204

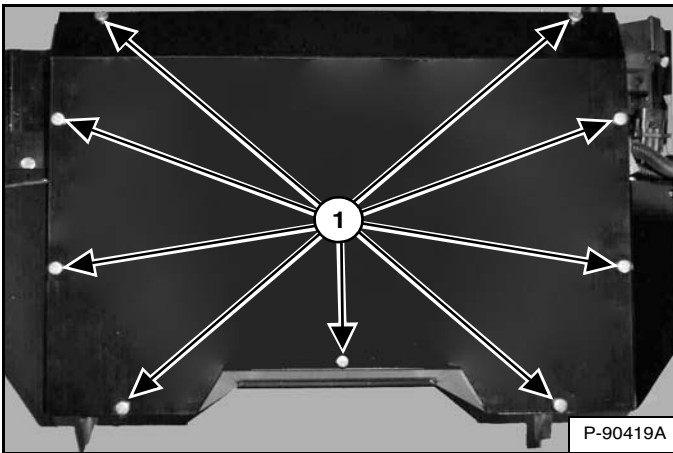

Remove cover screws (Item 1) [Figure 204] and remove the cover.

Figure 205

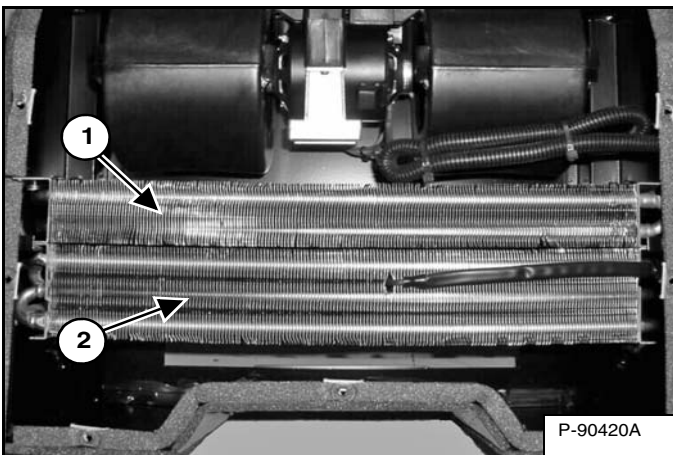

Use low pressure air or water to remove debris from the heater coil (Item 1) and evaporator (Item 2) [Figure 205].

Install the cover and lower the operator cab. (See Lowering on Page 142.)

Later Models

Raise the operator cab. (See Raising on Page 141.)

Figure 206

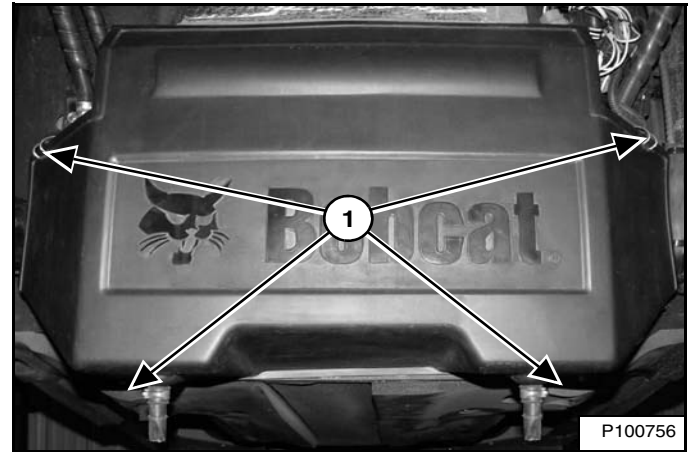

Unhook cover latches (Item 1) [Figure 206] and remove the cover.

Figure 207

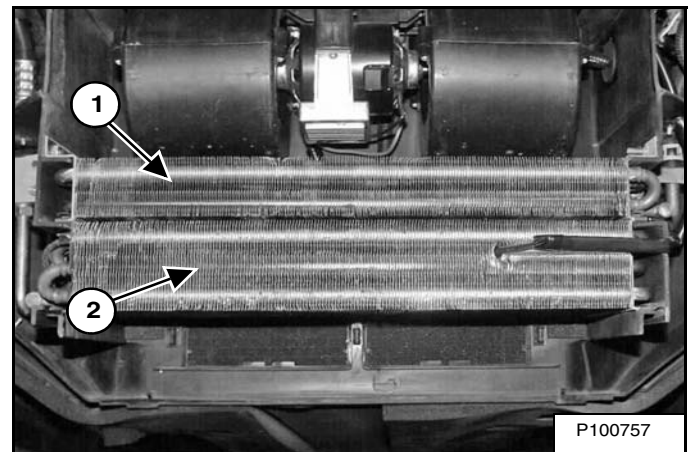

Use low pressure air or water to remove debris from the heater coil (Item 1) and evaporator (Item 2) [Figure 207].

Install the cover and lower the operator cab. (See Lowering on Page 142.)

HEATING, VENTILATION AND AIR CONDITIONING (HVAC) (CONT'D)

Condenser

The condenser should be cleaned with the oil cooler and the radiator. (See Cleaning on Page 155.)

Air Conditioning Lubrication

Run the air conditioning for about five minutes every week to lubricate the internal components.

Troubleshooting

If the fan does not run, or the air conditioning does not turn on, check the fuse. (See Fuse And Relay Location / Identification on Page 158.) If the air conditioning system circulates warm air, the refrigerant may need to be recharged.

AIR CLEANER SERVICE

Replacing Filter Elements

Figure 208



It is important to change the air filter element only when necessary. The service indicator (Item 1) will FLASH. Press the information button (Item 3) until the display screen (Item 2) shows the service codes. Service code [M0117] (Air Filter Plugged) will show in the display screen (Item 2) [Figure 208] when air filter change is necessary.

Replace the inner filter every third time the outer filter is replaced or as indicated.

Outer Filter

Figure 209

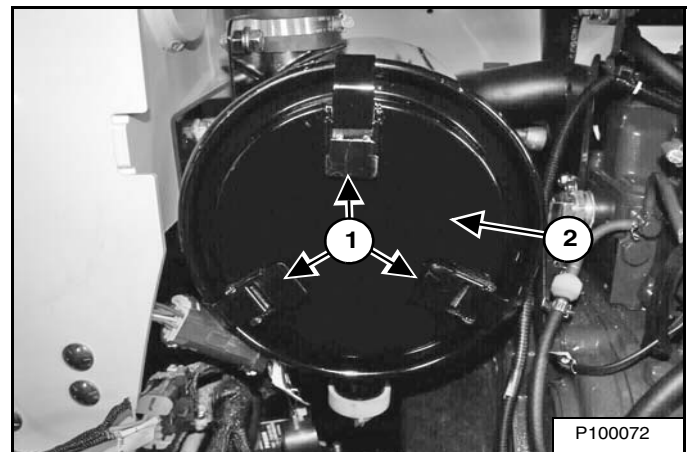

Open the latches (Item 1) and remove the dust cover (Item 2) [Figure 209].

AIR CLEANER SERVICE (CONT'D)

Replacing Filter Elements (Cont'd)

Outer Filter (Cont'd)

Figure 210

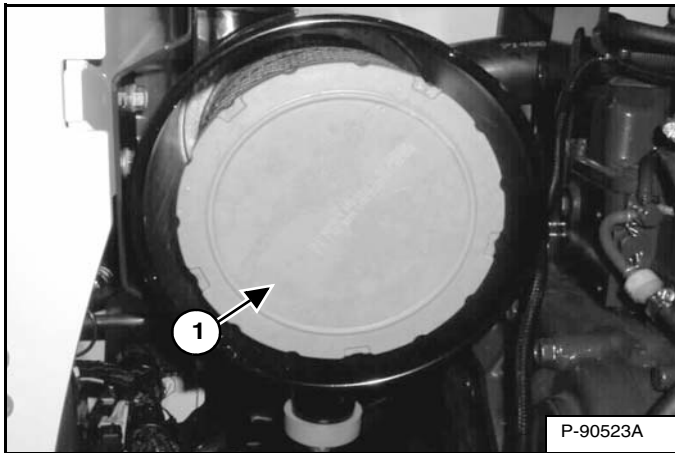

Pull the outer filter element (Item 1) [Figure 210] out and discard.

NOTE: Make sure all sealing surfaces are free of dirt and debris. DO NOT use compressed air.

Install new filter element. Push all the way in until it contacts the base of the housing.

Install the dust cover and secure the latches [Figure 209].

Inner Filter

Only replace the inner filter element under the following conditions:

- Replace the inner filter element every *third* time the outer filter is replaced.
- After the outer element has been replaced, start the engine and run at full rpm. If service code [M0117] (Air Filter Plugged) is still displayed in the data display, replace the inner filter element.

Remove the dust cover [Figure 209] and the outer filter element [Figure 210].

Figure 211

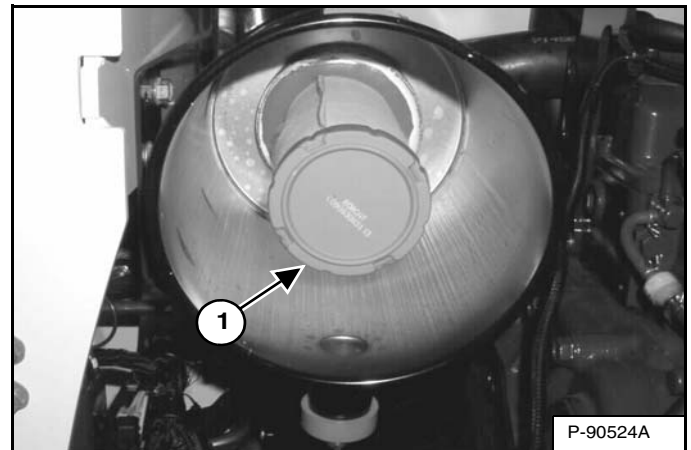

Remove the inner filter element (Item 1) [Figure 211].

NOTE: Make sure all sealing surfaces are free of dirt and debris. DO NOT use compressed air.

Install new inner filter element. Push all the way in until it contacts the base of the housing.

Install the outer filter element [Figure 210].

Figure 212

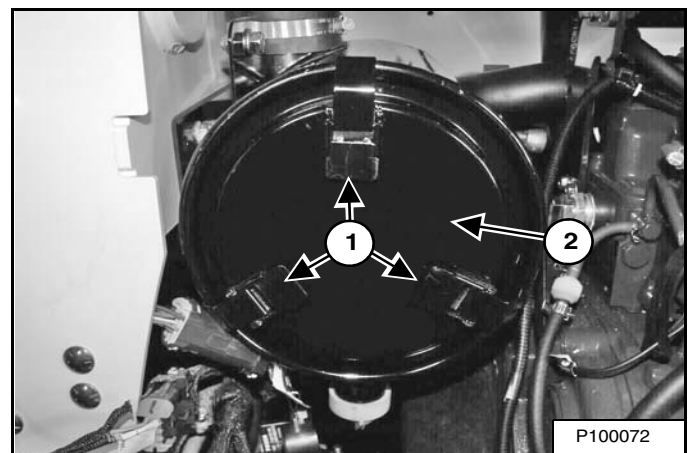

Install the dust cover (Item 2) and secure the latches (Item 1) [Figure 212].



FUEL SYSTEM

Fuel Specifications

Use only clean, high quality diesel fuel, Grade No. 2 or Grade No. 1.

The following is one suggested blending guideline which should prevent fuel gelling during cold temperatures:

TEMPERATURE	NO. 2	NO. 1
-9°C (+15°F)	100%	0%
Down to -29°C (-20°F)	50%	50%
Below -29°C (-20°F)	0%	100%

At a minimum, low sulfur diesel fuel must be used in this machine. Low sulfur is defined as 500 mg/kg (500 ppm) sulfur maximum.

The following fuels may also be used in this machine:

- Ultra low sulfur diesel fuel. Ultra low sulfur is defined as 15 mg/kg (15 ppm) sulfur maximum.
- Biodiesel blend fuel - Must contain no more than five percent biodiesel mixed with low sulfur or ultra low sulfur petroleum based diesel. This is commonly marketed as B5 blended diesel fuel. B5 blended diesel fuel must meet ASTM D975 (US Standard) or EN590 (EU Standard) specifications.

Biodiesel Blend Fuel

Biodiesel blend fuel has unique qualities that should be considered before using in this machine:

- Cold weather conditions can lead to plugged fuel system components and hard starting.
- Biodiesel blend fuel is an excellent medium for microbial growth and contamination which can cause corrosion and plugging of fuel system components.
- Use of biodiesel blend fuel may result in premature failure of fuel system components, such as plugged fuel filters and deteriorated fuel lines.
- Shorter maintenance intervals may be required, such as cleaning the fuel system and replacing fuel filters and fuel lines.
- Using biodiesel blended fuels containing more than five percent biodiesel can affect engine life and cause deterioration of hoses, tubelines, injectors, injector pump and seals.

Apply the following guidelines if biodiesel blend fuel is used:

- Ensure the fuel tank is as full as possible at all times to prevent moisture from collecting in the fuel tank.
- Ensure that the fuel tank cap is securely tightened.
- Biodiesel blend fuel can damage painted surfaces, remove all spilled fuel from painted surfaces immediately.
- Drain all water from the fuel filter daily before operating the machine.
- Do not exceed engine oil change interval. Extended oil change intervals can cause engine damage.
- Before vehicle storage; drain the fuel tank, refill with 100% petroleum diesel fuel, add fuel stabiliser and run the engine for at least 30 minutes.

NOTE: Biodiesel blend fuel does not have long term stability and should not be stored for more than three months.

FUEL SYSTEM (CONT'D)

Filling The Fuel Tank



AVOID INJURY OR DEATH

Stop and cool the engine before adding fuel. **NO SMOKING!** Failure to obey warnings can cause an explosion or fire.

W-2063-0807

Open the rear door.

Figure 213

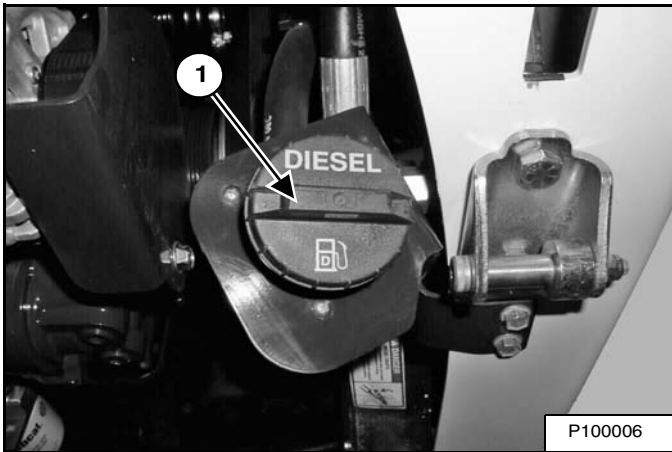

Remove the fill cap (Item 1) [Figure 213].

Figure 214

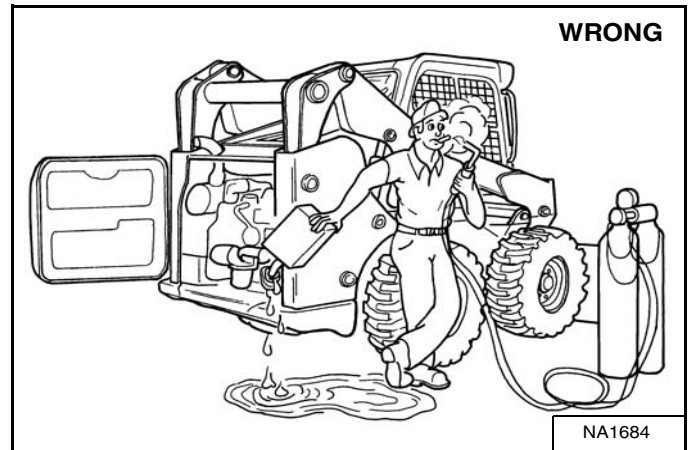

Use a clean, approved safety container to add fuel of the correct specification. Add fuel only in an area that has free movement of air and no open flames or sparks. **NO SMOKING!** [Figure 214].

Install and tighten the fuel cap (Item 1) [Figure 213].

Close the rear door.



AVOID INJURY OR DEATH

Always clean up spilled fuel or oil. Keep heat, flames, sparks or lighted tobacco away from fuel and oil. Failure to use care around combustibles can cause explosion or fire.

W-2103-0508

FUEL SYSTEM (CONT'D)

Fuel Filter

For the service interval for removing water from, or replacing the fuel filter (See SERVICE SCHEDULE on Page 131.)

Removing Water

Figure 215

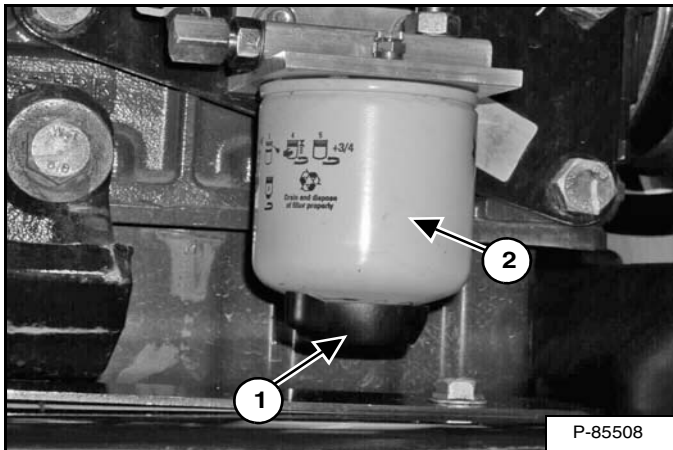

Loosen the drain (Item 1) [Figure 215] at the bottom of the filter element to remove water from the filter.

Replacing Element

Remove the filter element (Item 2) [Figure 215].

Clean the area around the filter housing. Put clean oil on the seal of the new filter element. Install the fuel filter, and hand tighten.

Remove air from the fuel system. (See Removing Air From The Fuel System on Page 152.)

WARNING

AVOID INJURY OR DEATH

Always clean up spilled fuel or oil. Keep heat, flames, sparks or lighted tobacco away from fuel and oil. Failure to use care around combustibles can cause explosion or fire.

W-2103-0508

Removing Air From The Fuel System

After replacing the filter element or when the fuel tank has run out of fuel, the air must be removed from the fuel system before starting the engine.

WARNING

AVOID INJURY OR DEATH

Diesel fuel or hydraulic fluid under pressure can penetrate skin or eyes, causing serious injury or death. Fluid leaks under pressure may not be visible. Use a piece of cardboard or wood to find leaks. Do not use your bare hand. Wear safety goggles. If fluid enters skin or eyes, get immediate medical attention from a doctor familiar with this injury.

W-2072-EN-0909

Figure 216

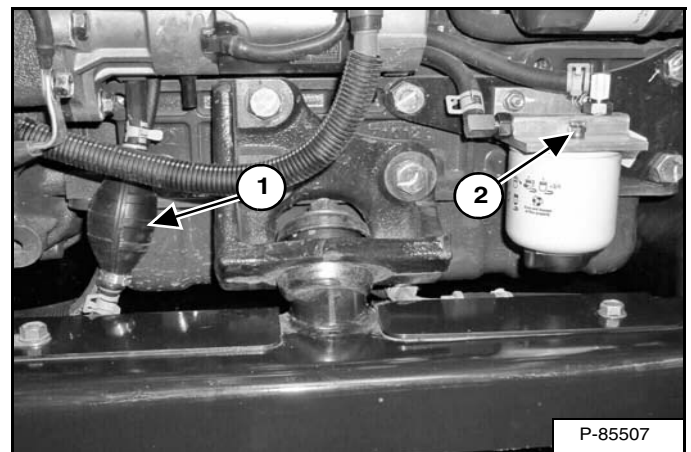

Open the vent (Item 2) [Figure 216] on the fuel filter housing.

Squeeze the hand pump (priming bulb) (Item 1) [Figure 216] until fuel flows from the vent with no air bubbles.

Close the vent (Item 2) [Figure 216].

ENGINE LUBRICATION SYSTEM

Checking And Adding Engine Oil

Check the engine oil level every day before starting the engine for the work shift.

Figure 217

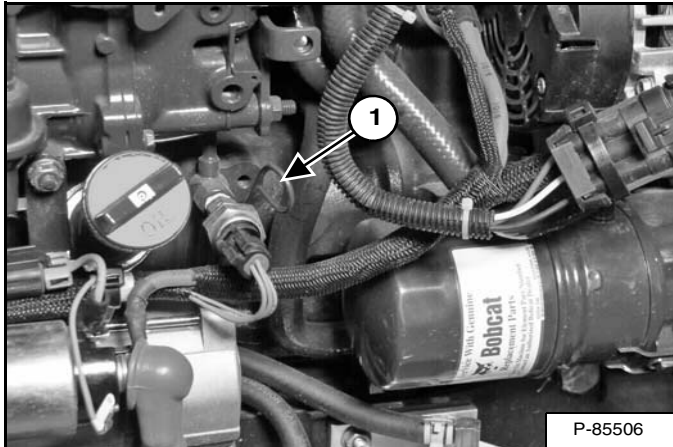

Park the machine on level ground. Open the rear door and remove the dipstick (Item 1) [Figure 217].

Keep the oil level between the marks on the dipstick. Do not overfill.

Engine Oil Chart

Figure 218

ENGINE OIL RECOMMENDED SAE VISCOSITY NUMBER (LUBRICATION OILS FOR DIESEL ENGINE CRANKCASE)

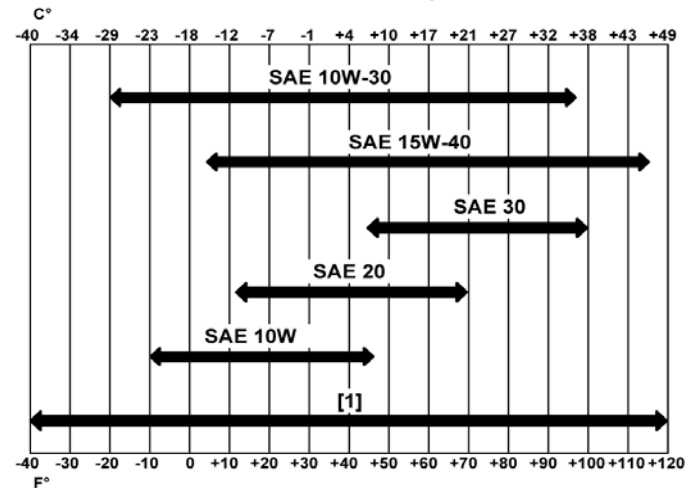

TEMPERATURE RANGE ANTICIPATED BEFORE NEXT OIL CHANGE (DIESEL ENGINES MUST USE API CLASSIFICATION CI-4 OR BETTER)

[1] Synthetic Oil - Use recommendation from Synthetic Oil Manufacturer.

Use good quality engine oil that meets API Service Classification of CI-4 or better [Figure 218].

WARNING

AVOID INJURY OR DEATH

Always clean up spilled fuel or oil. Keep heat, flames, sparks or lighted tobacco away from fuel and oil. Failure to use care around combustibles can cause explosion or fire.

W-2103-0508

ENGINE LUBRICATION SYSTEM (CONT'D)

Removing And Replacing Oil And Filter

For the service interval for replacing the engine oil and filter (See SERVICE SCHEDULE on Page 131.)

Run the engine until it is at operating temperature. Stop the engine.

Figure 219

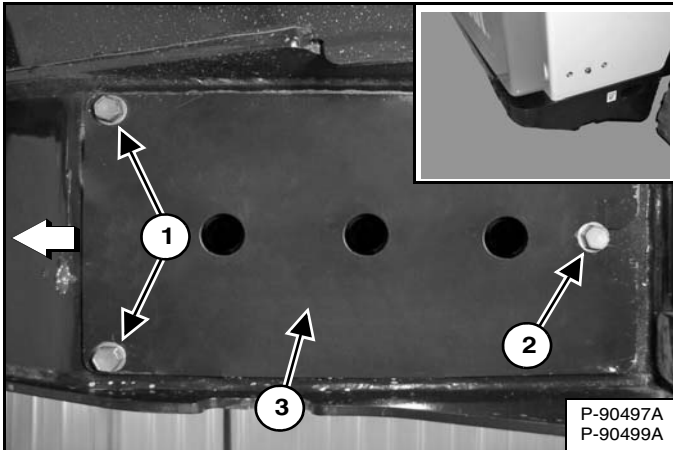

The oil drain hose is located behind a cover under the right rear corner of the loader (Inset) [Figure 219].

Remove two cover mounting bolts (Item 1) [Figure 219].

Loosen one cover mounting bolt (Item 2) and slide the cover (Item 3) [Figure 219] to the rear of the loader.

Figure 220

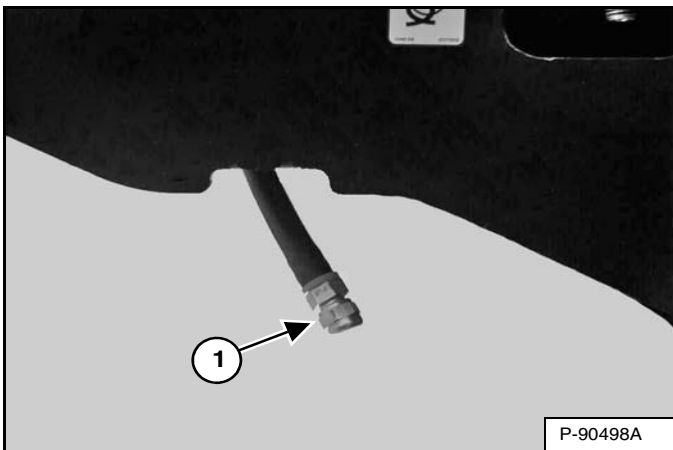

Remove the oil drain cap (Item 1) [Figure 220] from the oil drain hose and drain the oil into a container. Recycle or dispose of used oil in an environmentally safe manner.

Install and tighten the oil drain cap [Figure 220].

Install the cover and the cover mounting bolts [Figure 219]. Tighten all bolts.

Figure 221

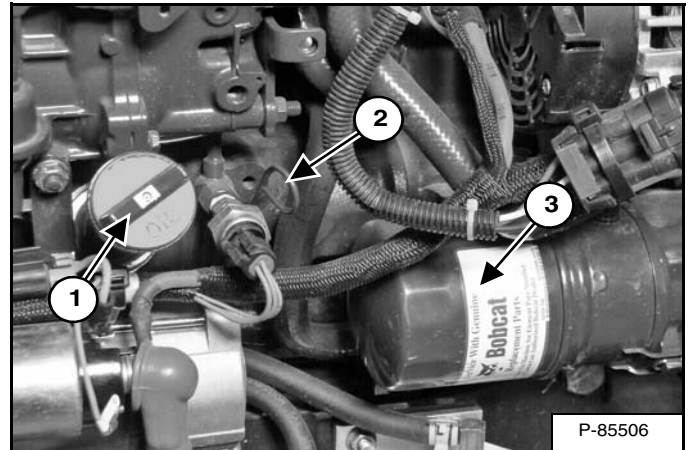

Open the rear door, remove the oil filter (Item 3) [Figure 221] and clean the filter housing surface.

Use genuine Bobcat filter only.

Put oil on the new filter gasket, install the filter and hand tighten.

Remove the oil fill cap (Item 1) [Figure 221].

Put oil in the engine. For the correct quantity (See Capacities on Page 205.) Do not overfill.

Start the engine and let it run for several minutes. Stop the engine and check for leaks at the filter.

Remove the dipstick (Item 2) [Figure 221] and check the oil level.

Add oil as needed if it is not at the top mark on the dipstick. Install the dipstick and close the rear door.

WARNING

AVOID INJURY OR DEATH

Always clean up spilled fuel or oil. Keep heat, flames, sparks or lighted tobacco away from fuel and oil. Failure to use care around combustibles can cause explosion or fire.

W-2103-0508

ENGINE COOLING SYSTEM

Check the cooling system every day to prevent overheating, loss of performance or engine damage.

Maintenance Platform

Figure 222

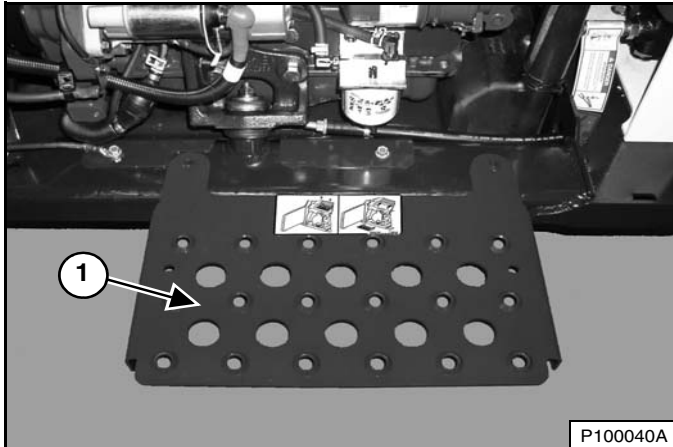

A maintenance platform (Item 1) [Figure 222] is available from your Bobcat dealer to facilitate access when cleaning the engine cooling system.

WARNING

AVOID INJURY OR DEATH

Wear safety glasses to prevent eye injury when any of the following conditions exist:

- When fluids are under pressure.
- Flying debris or loose material is present.
- Engine is running.
- Tools are being used.

W-2019-0907

Cleaning

Open the rear door. (See REAR DOOR (TAILGATE) on Page 144.)

Remove the rear grille. (See REAR GRILLE on Page 145.)

Loaders With Air Conditioning

Figure 223

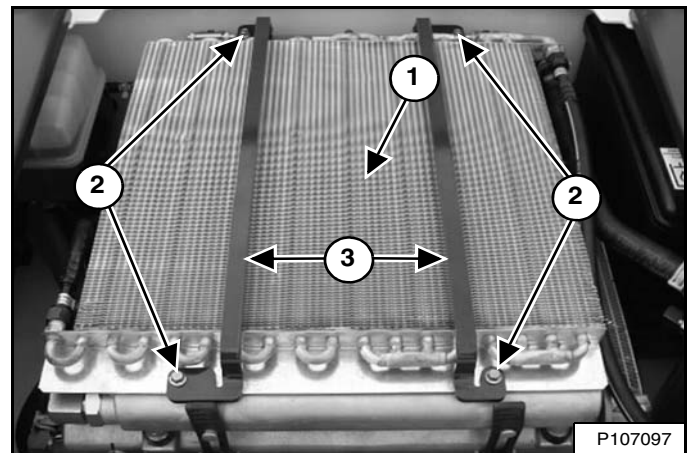

Use low air pressure or water pressure to clean the top of the air conditioning condenser (Item 1) [Figure 223].

The area between the air conditioning condenser and the oil cooler will require occasional cleaning. Remove the bolts (Item 2) and the brackets (Item 3) [Figure 223].

Figure 224

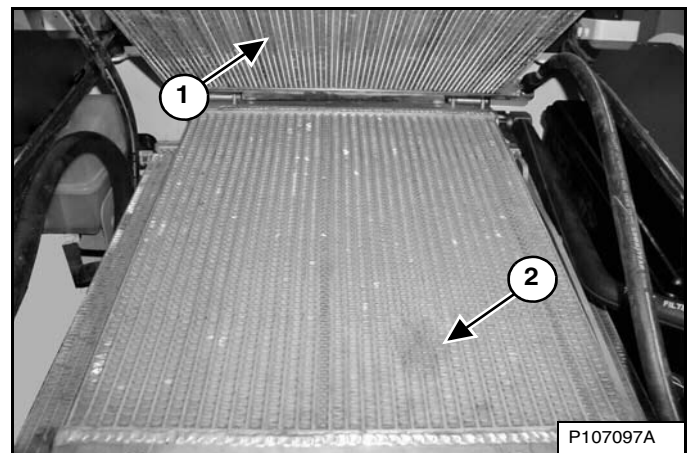

NOTE: Be careful when raising and lowering the air conditioning condenser so that the air conditioning condenser does not fall on the oil cooler and damage the fins.

Raise the air conditioning condenser (Item 1) and use low air pressure or water pressure to clean the top of the oil cooler (Item 2) [Figure 224].

Lower the air conditioning condenser (Item 1) [Figure 224]. Install the brackets (Item 3) [Figure 223] and the bolts (Item 2) [Figure 223].

ENGINE COOLING SYSTEM (CONT'D)

Cleaning (Cont'd)

Loaders Without Air Conditioning

Figure 225

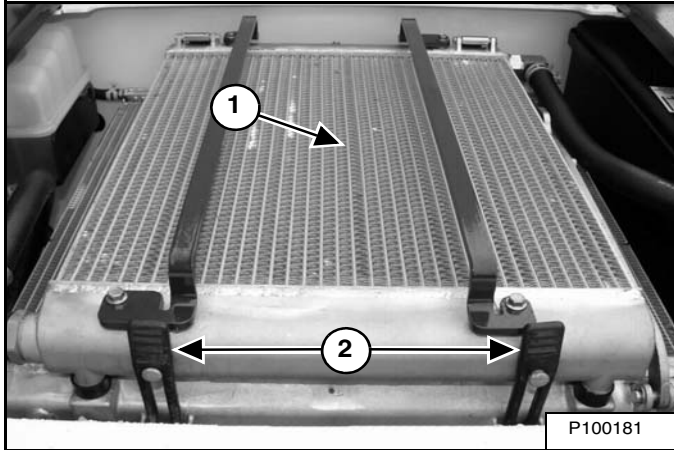

Use low air pressure or water pressure to clean the top of the oil cooler (Item 1) [Figure 225].

All Loaders

Unhook the two rubber straps (Item 2) [Figure 225].

Figure 226

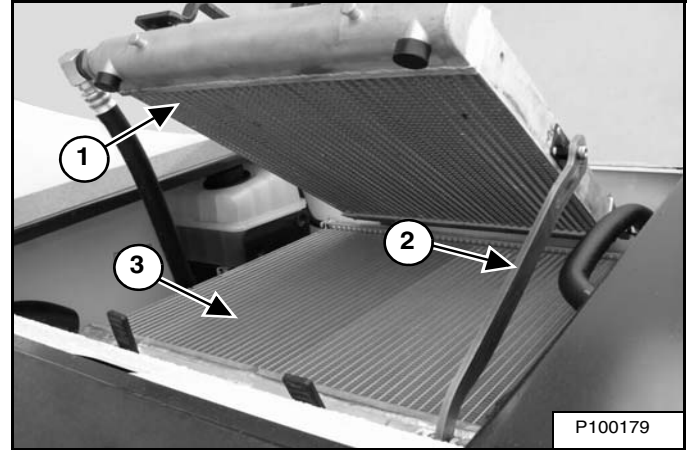

Raise the oil cooler (Item 1) until the bar (Item 2) drops into the last position to support the oil cooler. Use low air pressure or water pressure to clean the top of the radiator (Item 3) [Figure 226].

Raise the bar (Item 2) [Figure 226] slightly and lower the oil cooler. Fasten the two rubber straps.

Check the cooling system for leaks.

Install the rear grille and close the rear door.

ENGINE COOLING SYSTEM (CONT'D)

Checking Level

Open the rear door and raise the rear grille.

Figure 227

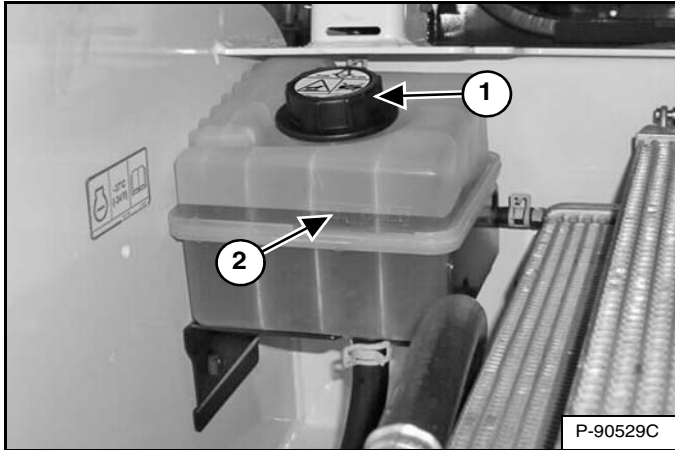

Check coolant level using the level markers (Item 2) [Figure 227] on the tank. Coolant must be between top and bottom level markers when the engine is cold.

NOTE: The loader is factory filled with propylene glycol coolant (purple colour). DO NOT mix propylene glycol with ethylene glycol.

Use a refractometer to check the condition of propylene glycol in your cooling system.

Lower the rear grille and close the rear door.

IMPORTANT

AVOID ENGINE DAMAGE

Always use the correct ratio of water to antifreeze.

Too much antifreeze reduces cooling system efficiency and may cause serious premature engine damage.

Too little antifreeze reduces the additives which protect the internal engine components; reduces the boiling point and freeze protection of the system.

Always add a premixed solution. Adding full strength concentrated coolant can cause serious premature engine damage.

I-2124-0497

Removing And Replacing Coolant

For the service interval for replacing the engine coolant (See SERVICE SCHEDULE on Page 131.)

Open the rear door and remove the rear grille.

Remove the coolant fill cap (Item 1) [Figure 227].

Figure 228

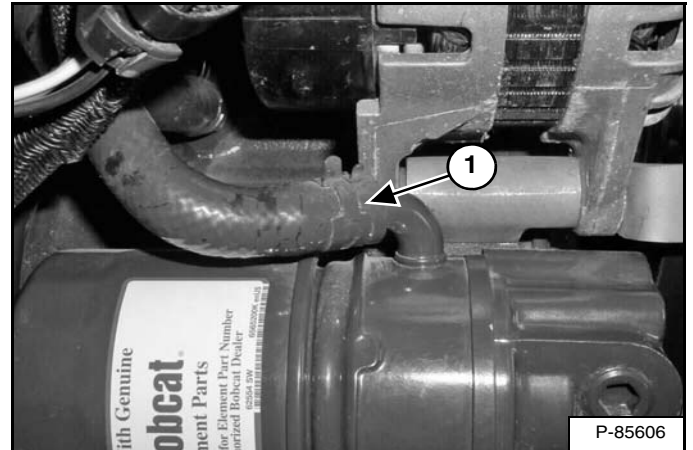

Disconnect the coolant hose (Item 1) [Figure 228] from the oil filter assembly. Drain the coolant into a container. Connect the coolant hose to the oil filter assembly. Recycle or dispose of coolant in an environmentally safe manner.

Mix new coolant in a separate container.

The correct mixture of coolant to provide a -37°C (-34°F) freeze protection is 5 L propylene glycol mixed with 4,4 L of water **OR** 1 U.S. gal propylene glycol mixed with 3.5 qt of water.

Add premixed coolant, 47% water and 53% propylene glycol to the coolant tank until the coolant level reaches the lower marker on the tank [Figure 227].

Install the coolant fill cap.

NOTE: When installing the coolant fill cap, the cap must be tightened until it clicks.

Run the engine until it is at operating temperature. Stop the engine. Check the coolant level when cool. Add coolant as needed.

Install the rear grille and close the rear door.

ELECTRICAL SYSTEM

Description

Figure 229

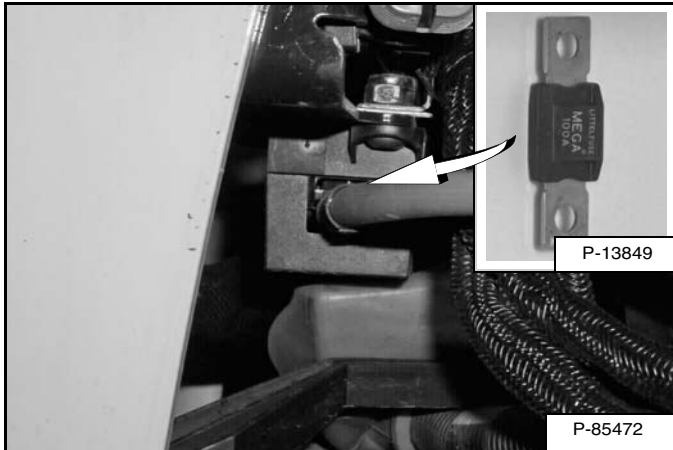

The loader has a 12 volt, negative earth, alternator charging system.

The electrical system is protected by fuses located in the operator cab (located under the operator cab in earlier models) and a 100 ampere master fuse [Figure 229] located under the air cleaner in the engine compartment.

The fuses will protect the electrical system when there is an electrical overload. The reason for the overload must be found before starting the engine again.

Fuse And Relay Location / Identification

Earlier Models

Raise the operator cab. (See Raising on Page 141.)

Figure 230

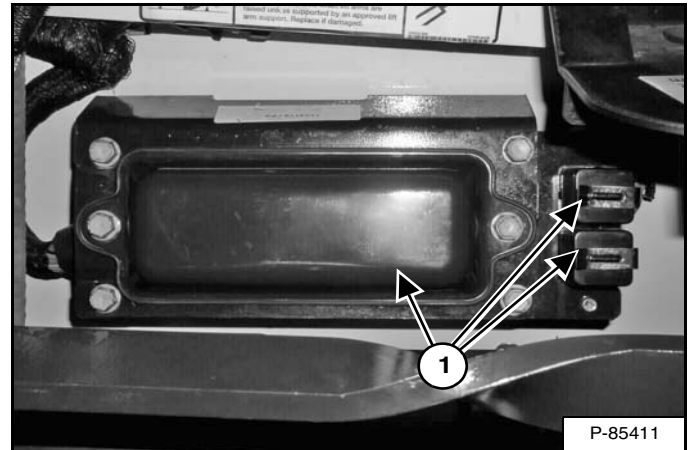

The electrical system is protected from overload by fuses and relays located under three fuse panel covers (Item 1) [Figure 230].

Figure 231



Remove the covers to check or replace the fuses [Figure 231].

A decal is located inside the large cover to show location and amperage ratings.

A table is provided with details on amperage ratings and circuits affected by each fuse and relay. (See Figure 235 on Page 160.)

ELECTRICAL SYSTEM (CONT'D)

Fuse And Relay Location / Identification (Cont'd)

Later Models

Figure 232

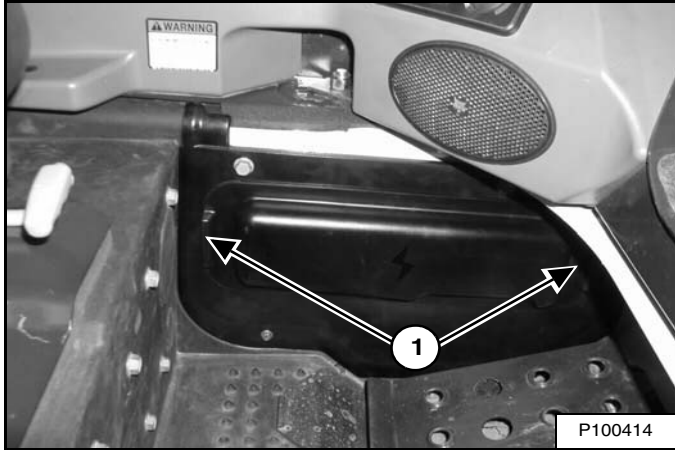

The fuse / relay panels are located behind an access panel near the left foot pedal / footrest. Pull the panel at each end (Item 1) [Figure 232] to remove.

Figure 233

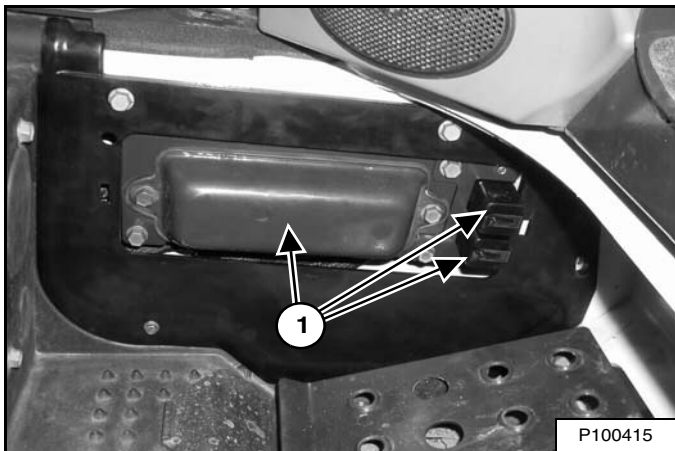

The electrical system is protected from overload by fuses and relays located under three fuse panel covers (Item 1) [Figure 233].

Figure 234



Remove the covers to check or replace the fuses [Figure 234].

A decal is located inside the access panel to show location and amperage ratings.

Line up the clips on the back of the access panel with the slots provided and push the panel into place when finished [Figure 232]. A locating pin prevents the panel from being installed upside down.

A table is provided with details on amperage ratings and circuits affected by each fuse and relay. (See Figure 235 on Page 160.)



ELECTRICAL SYSTEM (CONT'D)

Fuse And Relay Location / Identification (Cont'd)

Figure 235

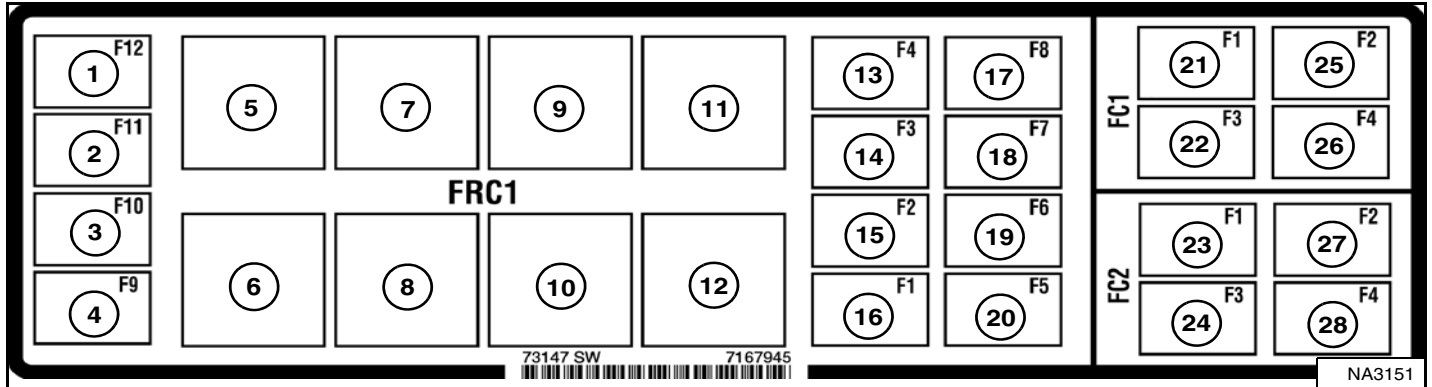

The location and amperage ratings are shown in the table below and on the decal [Figure 235]. Relays are identified by the letter “R” in the AMP column.

REF	ICON	DESCRIPTION	AMP	REF	ICON	DESCRIPTION	AMP	REF	ICON	DESCRIPTION	AMP
1		Alternator	15	11		Glow Plugs	R	21		Bobcat Controller	25
2		Heater / HVAC	25	12		Fuel Shutoff	R	22		ACS Controller	25
3		Front Lights	20	13		Cab Switched Power	5	23		Attachments	25
4		Rear Lights	15	14		Bucket Position	15	24		Not Used	--
5		Starter	R	15		Wiper / Washer	25	25		Auxiliary Controller	25
6		Front Lights	R	16		Switched Power & Back-up Alarm (Standard/ACS)	25	26		Drive Controller & Back-up Alarm (SJC)	25
7		Heater / HVAC	R	17		Switched Power	25	27		Accessories & Front Horn	25
8		Rear Lights	R	18		Switched Power	25	28		Power Port	15
9		Switched Power	R	19		Traction	30				
10		Traction	R	20		Fuel Shutoff	30				

ELECTRICAL SYSTEM (CONT'D)

Battery Maintenance

Figure 236

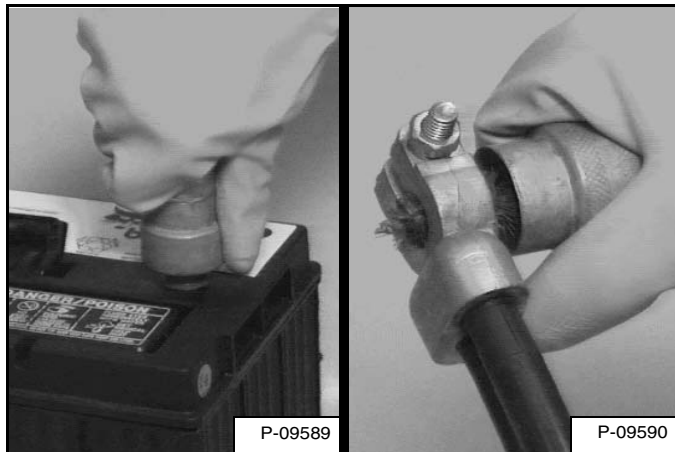

The battery cables must be clean and tight **[Figure 236]**. Check electrolyte level in the battery. Add distilled water as needed. Remove acid or corrosion from battery and cables with sodium bicarbonate (baking soda) and water solution.

Put Bobcat Battery Saver or grease on the battery terminals and cable ends to prevent corrosion.

WARNING

AVOID INJURY OR DEATH

Batteries contain acid which burns eyes and skin on contact. Wear goggles, protective clothing and rubber gloves to keep acid off body.

In case of acid contact, wash immediately with water. In case of eye contact get prompt medical attention and wash eye with clean, cool water for at least 15 minutes.

If electrolyte is taken internally drink large quantities of water or milk! DO NOT induce vomiting. Get prompt medical attention.

W-2065-0807

ELECTRICAL SYSTEM (CONT'D)

Using A Booster Battery (Jump Starting)

If it is necessary to use a booster battery to start the engine, BE CAREFUL! There must be one person in the operator's seat and one person to connect and disconnect the battery cables.

The key switch must be OFF or the STOP button must be pressed. The booster battery must be 12 volt.

WARNING

BATTERY GAS CAN EXPLODE AND CAUSE SERIOUS INJURY OR DEATH

Keep arcs, sparks, flames and lighted tobacco away from batteries. When *jumping* from booster battery make final connection (negative) at machine frame.

Do not jump start or charge a frozen or damaged battery. Warm battery to 16°C (60°F) before connecting to a charger. Unplug charger before connecting or disconnecting cables to battery. Never lean over battery while boosting, testing or charging.

W-2066-0910

Figure 237

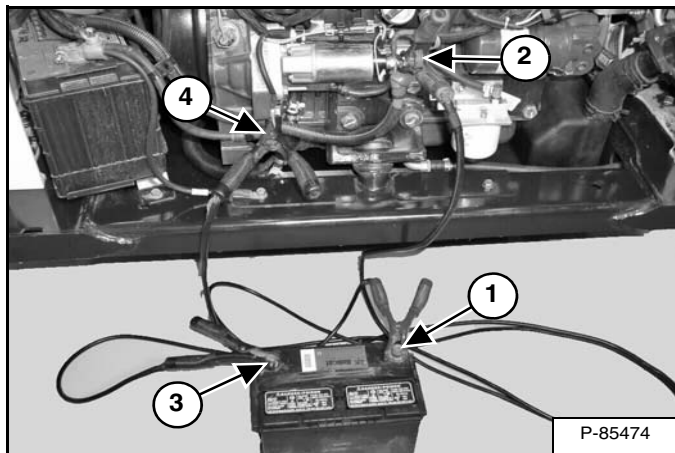

Connect the end of the first cable (Item 1) [Figure 237] to the positive (+) terminal of the booster battery. Connect the other end of the same cable (Item 2) [Figure 237] to the positive terminal on the loader starter.

Connect the end of the second cable (Item 3) [Figure 237] to the negative terminal of the booster battery. Connect the other end of the same cable (Item 4) [Figure 237] to the engine.

Keep cables away from moving parts. Start the engine. (See STARTING THE ENGINE on Page 92.)

After the engine has started, remove the negative (-) cable (Item 4) [Figure 237] first. Remove the cable from the positive terminal (Item 2) [Figure 237].

IMPORTANT

Damage to the alternator can occur if:

- Engine is operated with battery cables disconnected.
- Battery cables are connected when using a fast charger or when welding on the loader. (Remove both cables from the battery.)
- Extra battery cables (booster cables) are connected wrong.

I-2023-1285

ELECTRICAL SYSTEM (CONT'D)

Removing And Installing Battery

! WARNING

AVOID INJURY OR DEATH

Batteries contain acid which burns eyes and skin on contact. Wear goggles, protective clothing and rubber gloves to keep acid off body.

In case of acid contact, wash immediately with water. In case of eye contact get prompt medical attention and wash eye with clean, cool water for at least 15 minutes.

If electrolyte is taken internally drink large quantities of water or milk! DO NOT induce vomiting. Get prompt medical attention.

W-2065-0807

Open the rear door.

Figure 238

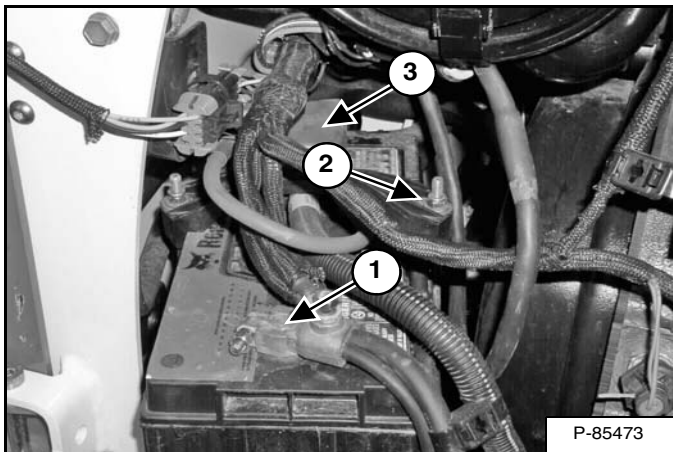

Disconnect the negative (-) cable (Item 1) [Figure 238].

Remove the battery hold down clamp (Item 2) [Figure 238].

Disconnect the positive (+) cable (Item 3) [Figure 238] from the battery.

Remove the battery from the loader.

Figure 239

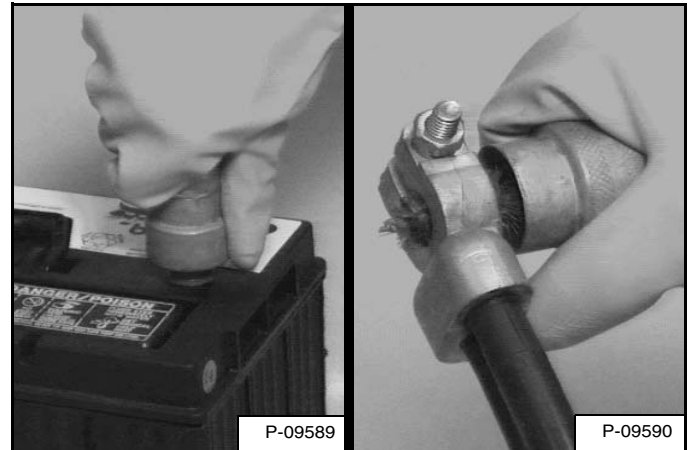

Always clean the battery terminals and cable ends when installing a new or used battery [Figure 239].

When installing the battery in the loader, do not touch any metal parts with the battery terminals.

Connect the negative (-) cable last to prevent sparks.

Connect and tighten the battery cables.

Install and tighten the battery hold down.

! WARNING

BATTERY GAS CAN EXPLODE AND CAUSE SERIOUS INJURY OR DEATH

Keep arcs, sparks, flames and lighted tobacco away from batteries. When *jumping* from booster battery make final connection (negative) at machine frame.

Do not jump start or charge a frozen or damaged battery. Warm battery to 16°C (60°F) before connecting to a charger. Unplug charger before connecting or disconnecting cables to battery. Never lean over battery while boosting, testing or charging.

W-2066-0910

HYDRAULIC / HYDROSTATIC SYSTEM

Checking And Adding Fluid

Check the hydraulic / hydrostatic fluid level every day before starting the work shift.

Park the loader on a level surface, lower the lift arms and place the attachment flat on the ground or tilt the Bob-Tach fully back if no attachment is installed.

Stop the engine.

Figure 240

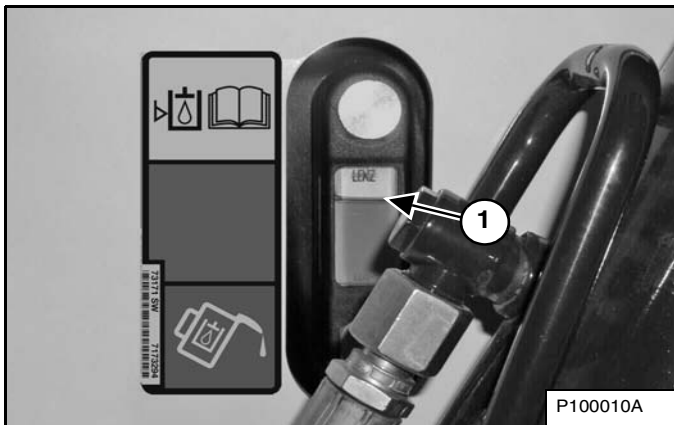

Check the fluid level in the sight gauge (Item 1) [Figure 240]. Keep the fluid level within the operating range.

Remove the rear grille. (See REAR GRILLE on Page 145.)

Figure 241

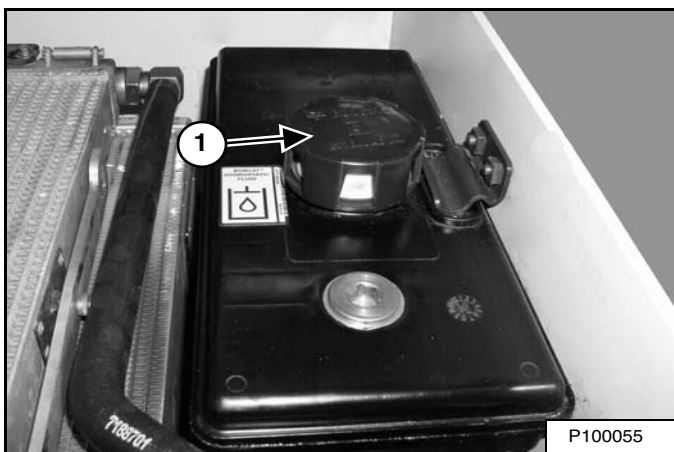

Remove the fill cap (Item 1) [Figure 241].

Add fluid as needed to bring the level within the operating range in the sight gauge (Item 1) [Figure 240].

Install the fill cap (Item 1) [Figure 241].

Install the rear grille.

Hydraulic / Hydrostatic Fluid Chart

Figure 242
HYDRAULIC / HYDROSTATIC FLUID
RECOMMENDED ISO VISCOSITY GRADE (VG)
AND VISCOSITY INDEX (VI)

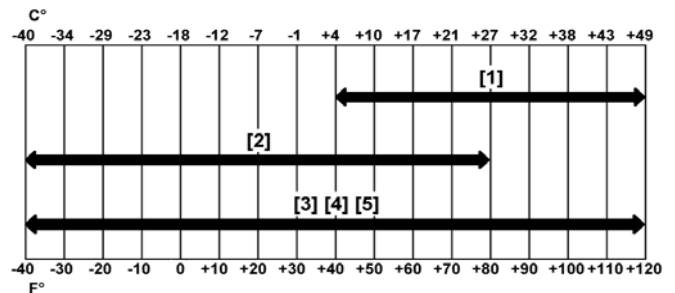

TEMPERATURE RANGE ANTICIPATED
DURING MACHINE USE

- [1] VG 100; Minimum VI 130
- [2] VG 46; Minimum VI 150
- [3] BOBCAT All-Season Fluid
- [4] BOBCAT Synthetic Fluid
- [5] BOBCAT Biodegradable Hydraulic / Hydrostatic Fluid (Unlike biodegradable fluids that are vegetable based, Bobcat biodegradable fluid is formulated to prevent oxidation and thermal breakdown at operating temperatures.)

Use only recommended fluid in the hydraulic system [Figure 242].



AVOID INJURY OR DEATH

Always clean up spilled fuel or oil. Keep heat, flames, sparks or lighted tobacco away from fuel and oil. Failure to use care around combustibles can cause explosion or fire.

W-2103-0508

HYDRAULIC / HYDROSTATIC SYSTEM (CONT'D)

Removing And Replacing Hydraulic Fluid

For the correct service interval (See SERVICE SCHEDULE on Page 131.)

Replace the fluid if it becomes contaminated or after major repair.

Always replace the hydraulic / hydrostatic filter and the hydraulic charge filter whenever the hydraulic fluid is replaced. (See Removing And Replacing Hydraulic / Hydrostatic Filter on Page 167.)

Remove the rear grille. (See REAR GRILLE on Page 145.)

Figure 243

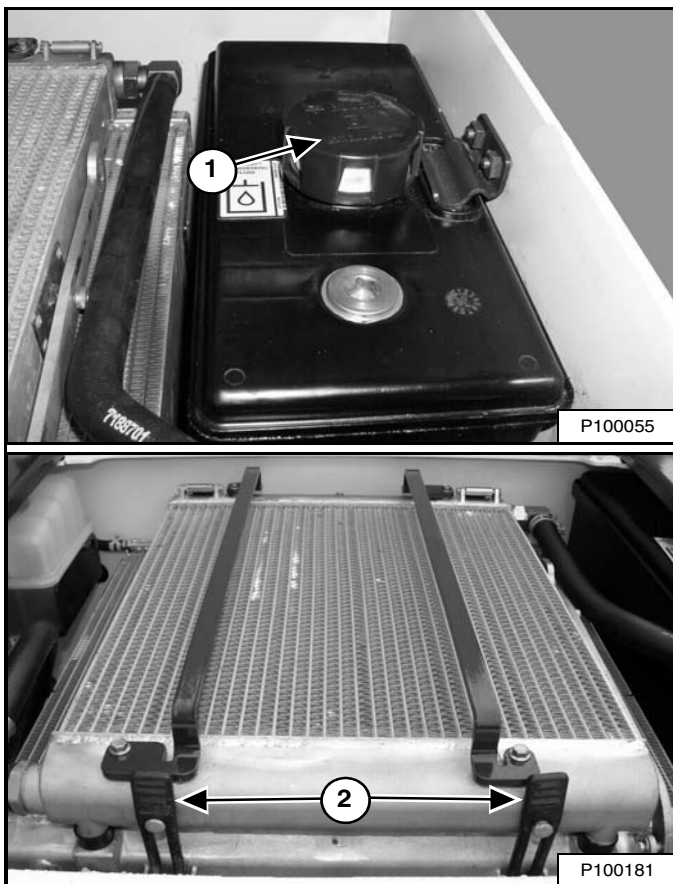

Remove the hydraulic fill cap (Item 1) and unhook the two rubber straps (Item 2) [Figure 243].

Figure 244

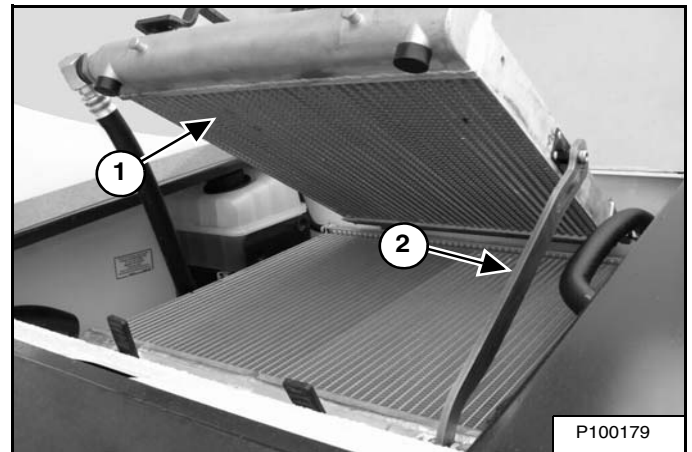

Raise the oil cooler (Item 1) until the bar (Item 2) [Figure 244] drops into the last position to support the oil cooler. This will aid in draining the hydraulic fluid.

Figure 245

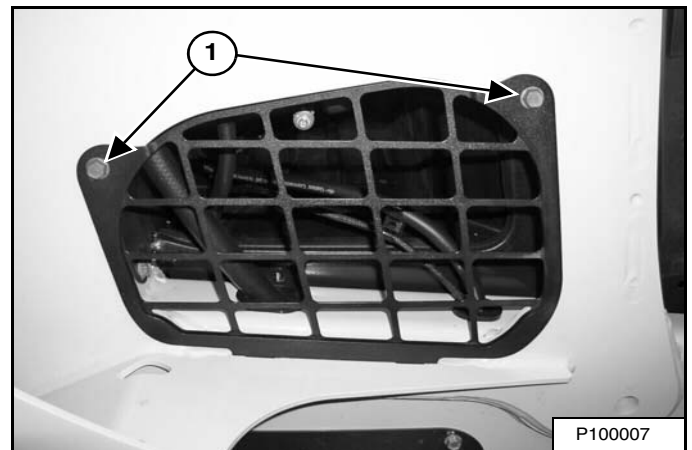

Remove the right side access cover bolts (Item 1) [Figure 245] and remove the cover. (Lift arms shown raised for visual clarity.)

HYDRAULIC / HYDROSTATIC SYSTEM (CONT'D)

Removing And Replacing Hydraulic Fluid (Cont'd)

Figure 246

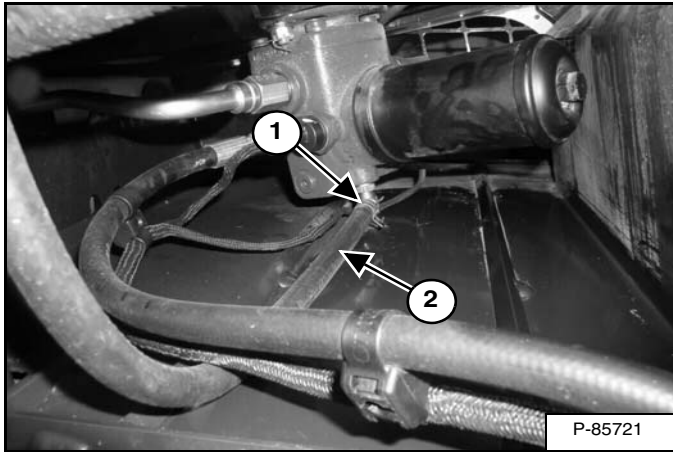

Remove the clamp (Item 1). Pinch off the hose (Item 2) [Figure 246] near the fitting and disconnect hose from the fitting. Route the hose out the side of the loader and drain the fluid into a container.

Connect the hose to the fitting when the fluid stops draining.

Recycle or dispose of used fluid in an environmentally safe manner.

WARNING

AVOID INJURY OR DEATH

Always clean up spilled fuel or oil. Keep heat, flames, sparks or lighted tobacco away from fuel and oil. Failure to use care around combustibles can cause explosion or fire.

W-2103-0508

Install the side access cover.

Raise the bar supporting the oil cooler and lower the oil cooler. Fasten the two rubber straps.

Figure 247

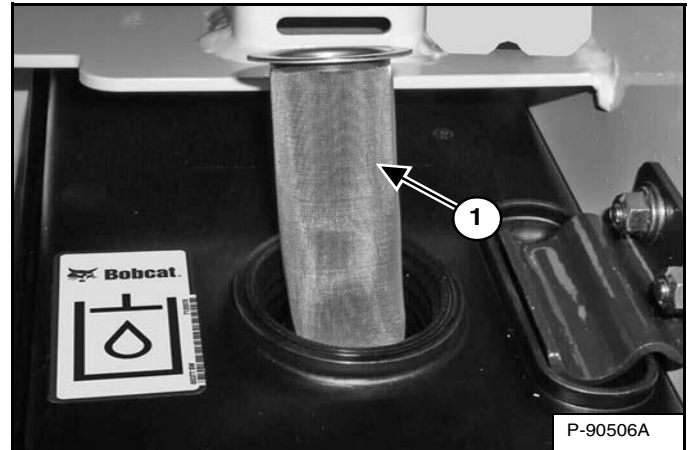

Remove and clean the hydraulic fill screen (Item 1) [Figure 247]. Use low air pressure to dry the screen.

Install hydraulic fill screen and add the correct fluid to the reservoir until the fluid level is within the operating range of the sight gauge. (See Capacities on Page 205.) and (See Checking And Adding Fluid on Page 164.)

Install the hydraulic fill cap.

Install the rear grille.

Start the engine and operate the loader hydraulic controls.

Stop the engine and check for leaks.

Check the fluid level in the reservoir and add as needed. (See Checking And Adding Fluid on Page 164.)

HYDRAULIC / HYDROSTATIC SYSTEM (CONT'D)

Removing And Replacing Hydraulic / Hydrostatic Filter

For the correct service interval (See SERVICE SCHEDULE on Page 131.)

Remove the rear grille. (See REAR GRILLE on Page 145.)

The filter housing is located behind the hydraulic fluid reservoir.

Clean the top of the filter housing.

Figure 248

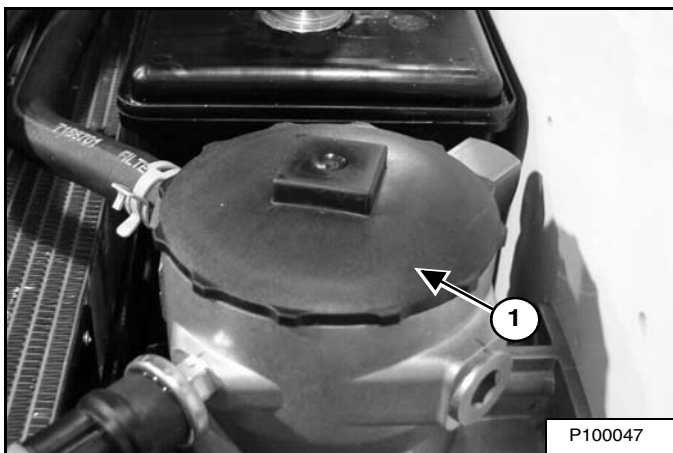

Remove the filter cap (Item 1) [Figure 248].

Figure 249

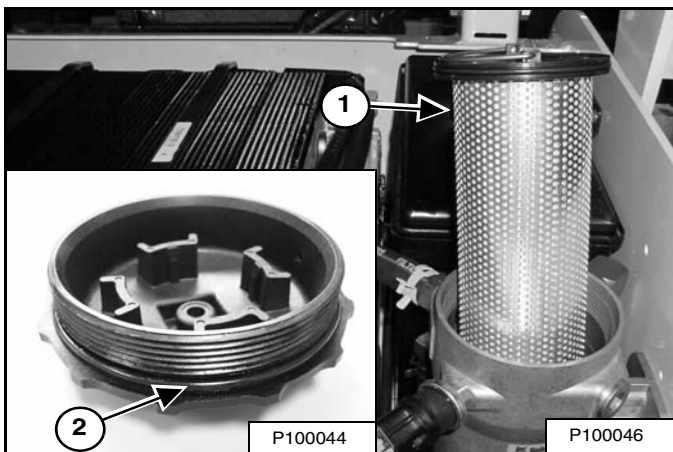

Remove the filter element (Item 1) [Figure 249] and discard.

Remove the O-ring (Item 2) [Figure 249] and discard.

Install new O-ring and lubricate with clean oil.

Install new filter element ensuring that element is fully seated in the housing.

Install the filter cap and tighten to 25 N•m (18 ft-lb) torque.

WARNING

AVOID INJURY OR DEATH

Always clean up spilled fuel or oil. Keep heat, flames, sparks or lighted tobacco away from fuel and oil. Failure to use care around combustibles can cause explosion or fire.

W-2103-0508

Install the rear grille.

Start the engine and operate the loader hydraulic controls.

WARNING

AVOID INJURY OR DEATH

Diesel fuel or hydraulic fluid under pressure can penetrate skin or eyes, causing serious injury or death. Fluid leaks under pressure may not be visible. Use a piece of cardboard or wood to find leaks. Do not use your bare hand. Wear safety goggles. If fluid enters skin or eyes, get immediate medical attention from a doctor familiar with this injury.

W-2072-EN-0909

Stop the engine and check for leaks at the filter.

Check the fluid level in the reservoir and add as needed. (See Checking And Adding Fluid on Page 164.)

HYDRAULIC / HYDROSTATIC SYSTEM (CONT'D)

Removing And Replacing Hydraulic Charge Filter

The hydraulic charge filter is located under the operator cab. For the correct service interval (See SERVICE SCHEDULE on Page 131.)

Raise the operator cab. (See Raising on Page 141.)

Figure 250

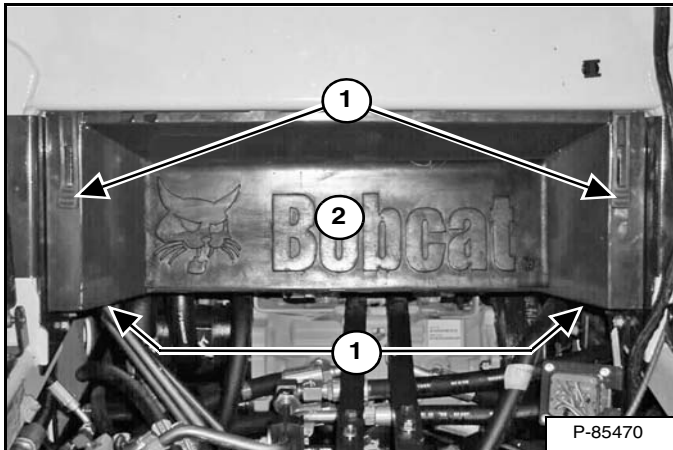

Unhook the four rubber straps (Item 1) and remove the lower fan duct (Item 2) [Figure 250].

Figure 251

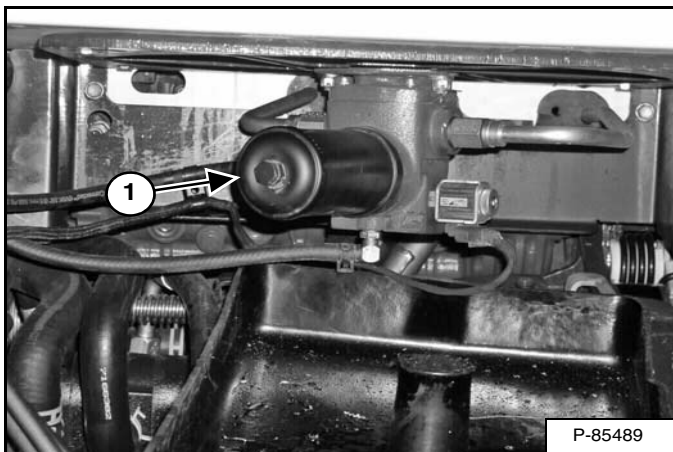

Place a suitable container below the filter housing and remove the filter housing (Item 1) [Figure 251] using a socket wrench.

Recycle or dispose of used fluid in an environmentally safe manner.

Figure 252

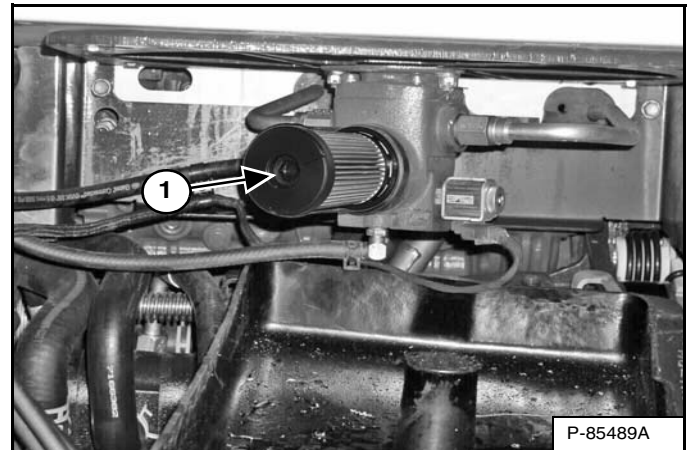

Remove and discard the filter element (Item 1) [Figure 252].

Clean the surface of the filter housing and the filter base where they contact the filter element seal.

Put clean oil on the seal of the new filter element. Install the element on the filter base. Install and tighten the filter housing to 47 - 54 N•m (35 - 40 ft-lb) torque.

WARNING

AVOID INJURY OR DEATH

Always clean up spilled fuel or oil. Keep heat, flames, sparks or lighted tobacco away from fuel and oil. Failure to use care around combustibles can cause explosion or fire.

W-2103-0508

Install the lower fan duct [Figure 250].

NOTE: Failure to install the lower fan duct correctly may result in decreased cooling.

Lower the operator cab. (See Lowering on Page 142.)

Start the engine and operate the loader hydraulic controls.

HYDRAULIC / HYDROSTATIC SYSTEM (CONT'D)

Removing And Replacing Hydraulic Charge Filter (Cont'd)



AVOID INJURY OR DEATH

Diesel fuel or hydraulic fluid under pressure can penetrate skin or eyes, causing serious injury or death. Fluid leaks under pressure may not be visible. Use a piece of cardboard or wood to find leaks. Do not use your bare hand. Wear safety goggles. If fluid enters skin or eyes, get immediate medical attention from a doctor familiar with this injury.

W-2072-EN-0909

Stop the engine and check for leaks at the filter.

Check the fluid level in the reservoir and add as needed. (See Checking And Adding Fluid on Page 164.)

Breather Cap

See the SERVICE SCHEDULE for the correct replacement interval. (See SERVICE SCHEDULE on Page 131.)

Remove the rear grille. (See REAR GRILLE on Page 145.)

Figure 253



Remove the breather cap (Item 1) [Figure 253] and discard.

Install new breather cap.

Install the rear grille.

SPARK ARRESTER MUFFLER

Cleaning Procedure

See the SERVICE SCHEDULE for service interval for cleaning the spark arrester muffler. (See SERVICE SCHEDULE on Page 131.)

Do not operate the loader with a defective exhaust system.

IMPORTANT

This machine is factory equipped with a spark arrester exhaust system.

The spark arrester muffler, if equipped, must be cleaned to keep it in working condition. The spark arrester muffler must be serviced by dumping the spark chamber every 100 hours of operation.

On some models, the turbocharger functions as the spark arrester and must operate correctly for proper spark arrester function.

If this machine is operated on flammable forest, brush, or grass covered land, a spark arrester attached to the exhaust system may be required and must be maintained in working order. Refer to local laws and regulations for spark arrester requirements.

I-2284-EN-0909

Stop the engine and open the rear door. (See REAR DOOR (TAILGATE) on Page 144.)

Figure 254

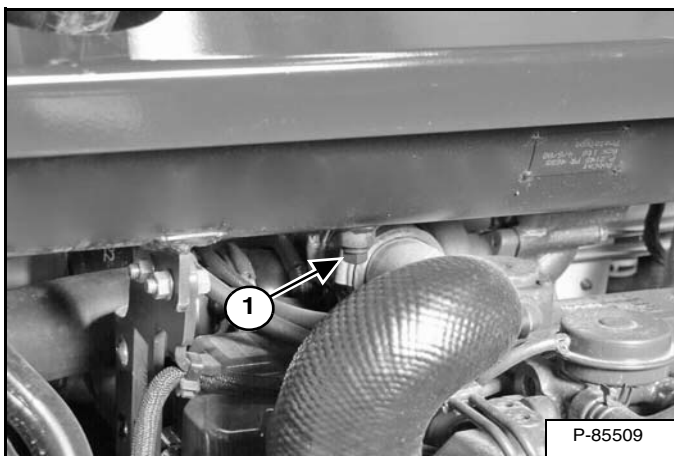

Remove the plug (Item 1) [Figure 254] from the bottom of the muffler.

! WARNING

When the engine is running during service, the driving and steering controls must be in neutral and the parking brake engaged. Failure to do so can cause injury or death.

W-2006-1209

Start the engine and run for about 10 seconds while a second person, wearing safety glasses, holds a piece of wood over the outlet of the muffler.

This will force contaminants out through the cleanout hole.

Stop the engine.

Install and tighten the plug. Close the rear door.

! WARNING

AVOID INJURY OR DEATH

When an engine is running in an enclosed area, fresh air must be added to avoid concentration of exhaust fumes. If the engine is stationary, vent the exhaust outside. Exhaust fumes contain odorless, invisible gases which can kill without warning.

W-2050-0807

! WARNING

Stop engine and allow the muffler to cool before cleaning the spark chamber. Wear safety goggles. Failure to obey can cause serious injury.

W-2011-1285

! WARNING

Never use machine in atmosphere with explosive dust or gases or where exhaust can contact flammable material. Failure to obey warnings can cause injury or death.

W-2068-1285

TYRE MAINTENANCE

Wheel Nuts

Figure 255



See your SERVICE SCHEDULE for the correct interval to check the wheel nuts [Figure 255]. (See SERVICE SCHEDULE on Page 131.)

When *installing* wheel nuts, tighten to 217 N•m (160 ft-lb) torque.

When *checking* wheel nut torque, set the torque wrench to 190 N•m (140 ft-lb) to prevent over-tightening.

Rotating

Check the tyres regularly for wear, damage and pressure.

Figure 256

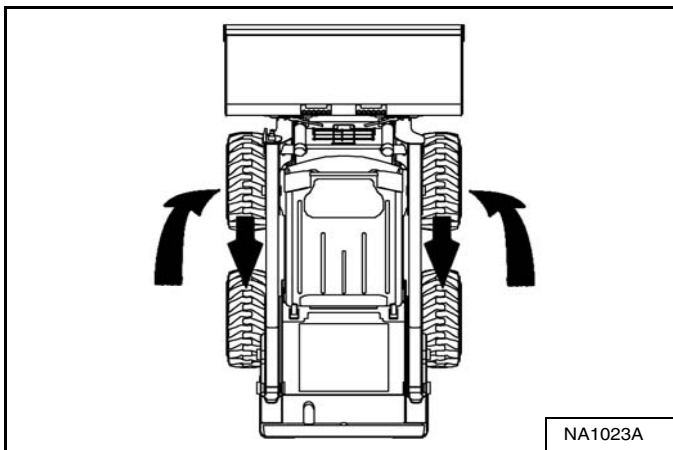

Rear tyres usually wear faster than front tyres. To keep tyre wear even, move the front tyres to the rear and rear tyres to the front [Figure 256].

It is important to keep the same size tyres on each side of the loader. If different sizes are used, each tyre will be turning at a different rate and cause excessive wear. The tread bars of all the tyres must face the same direction.

Recommended tyre pressure must be maintained to avoid excessive tyre wear and loss of stability and handling capability. Check for correct pressure before operating the loader.

Mounting

Tyres are to be repaired only by an authorised person using the proper procedures and safe equipment.

Tyres and rims must always be checked for correct size before mounting. Check rim and tyre bead for damage.

The rim flange must be cleaned and free of rust.

The tyre bead and rim flange must be lubricated with a rubber lubricant before mounting the tyre.

Avoid excessive pressure which can rupture the tyre and cause serious injury or death.

During inflation of the tyre, check the tyre pressure frequently to avoid over inflation.

WARNING

AVOID INJURY OR DEATH

Do not inflate tyres above specified pressure. Failure to use correct tyre mounting procedure can cause an explosion which can result in injury or death.

W-2078-EN-0909

IMPORTANT

Inflate tyres to the MAXIMUM pressure shown on the sidewall of the tyre. DO NOT mix brands of tyres used on the same machine.

I-2057-EN-1010

FINAL DRIVE TRANSMISSION (CHAINCASE)

Checking And Adding Oil

The chaincase contains the final drive sprockets and chains and uses the same type of oil as the hydraulic / hydrostatic system. (See Hydraulic / Hydrostatic Fluid Chart on Page 164.)

Stop the loader on a level surface and stop the engine.

Figure 257

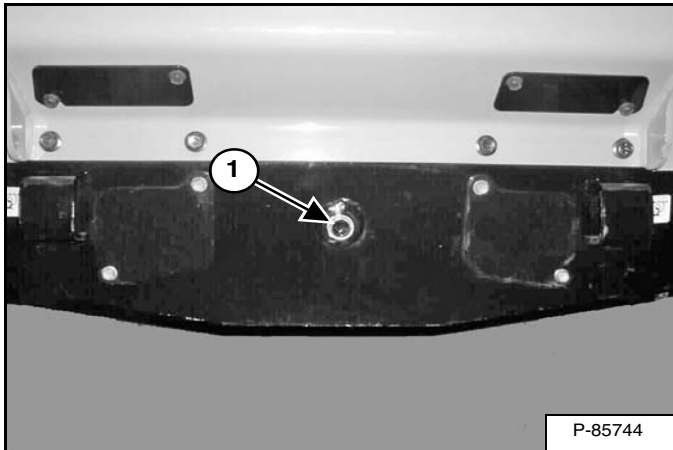

Remove the check plug (Item 1) [Figure 257] from the front of the chaincase housing. (Lift arms shown raised for clarity.)

If oil can be reached with the tip of your finger through the hole, the oil level is correct.

If the level is low, add oil through the check plug hole until the oil flows from the hole.

Install and tighten the plug.

Removing And Replacing Oil

Figure 258

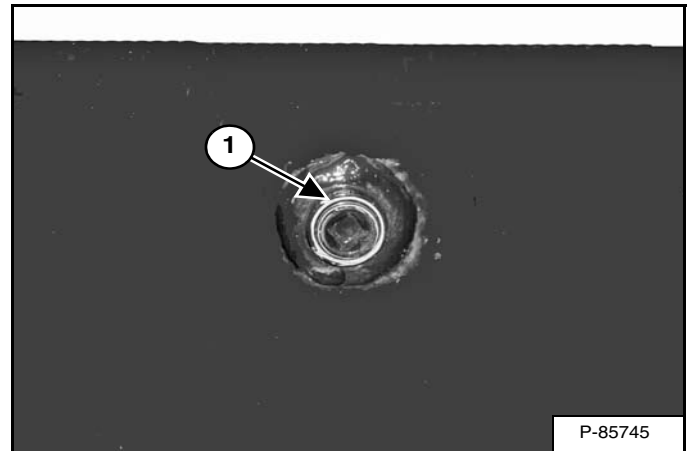

Remove the check plug (Item 1) [Figure 258] from the front of the chaincase housing.

Figure 259

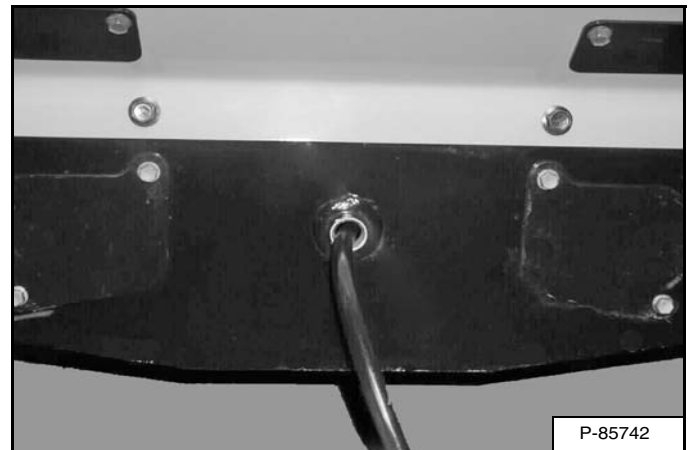

Pump the oil out of the chaincase [Figure 259].

Recycle or dispose of the used oil in an environmentally safe manner.

Add oil through the check plug hole until the oil flows from the hole.

WARNING

AVOID INJURY OR DEATH

Always clean up spilled fuel or oil. Keep heat, flames, sparks or lighted tobacco away from fuel and oil. Failure to use care around combustibles can cause explosion or fire.

W-2103-0508

ALTERNATOR BELT

Belt Adjustment

The alternator belt is a special maintenance free type that is pretensioned over the pulleys. This belt eliminates the need for a tensioning device and does not require periodic adjustment. Contact your Bobcat dealer for replacement parts.

Belt Replacement

Stop the engine and open the rear door. (See REAR DOOR (TAILGATE) on Page 144.)

Remove the air conditioning belt. (See AIR CONDITIONING BELT on Page 175.)

Earlier Models

Figure 260

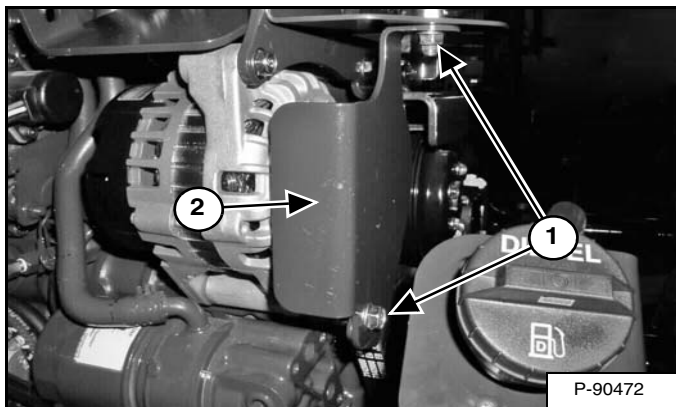

Remove the belt shield mounting nuts and bolts (Item 1) and remove the belt shield (Item 2) [Figure 260].

Figure 261

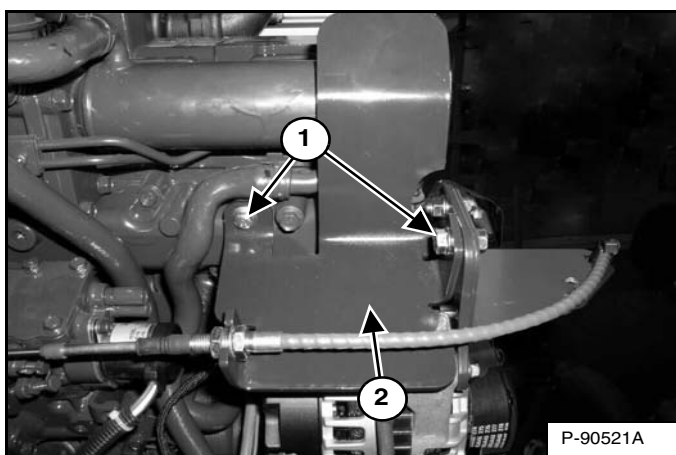

Remove the cable bracket mounting nut and bolts (Item 1) and move the cable bracket (Item 2) [Figure 261] up slightly.

Later Models

Figure 262

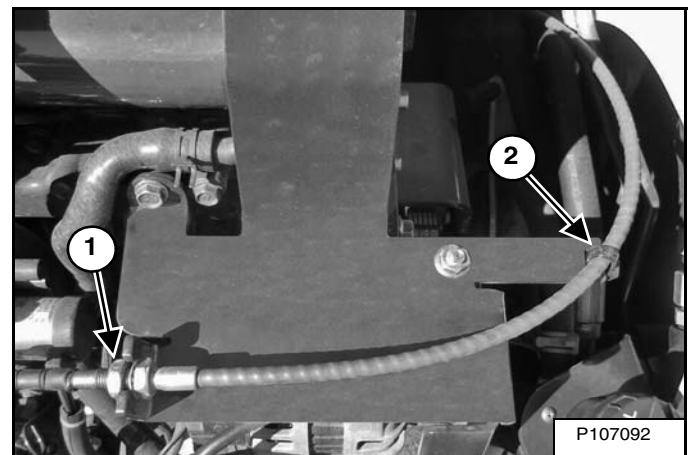

Loosen the throttle cable nut (Item 1) and cut the tie-strap (Item 2) [Figure 262].

ALTERNATOR BELT (CONT'D)

Belt Replacement (Cont'd)

Later Models (Cont'd)

Figure 263

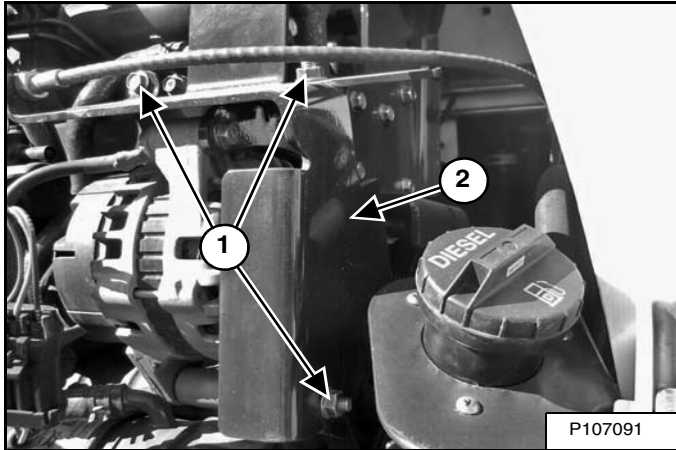

Remove the throttle bracket mounting nuts and bolts (Item 1) and remove the throttle bracket (Item 2) [Figure 263].

All Models

Figure 264

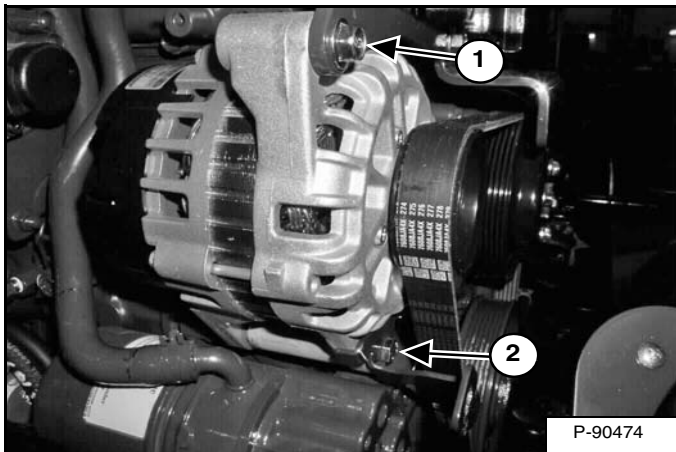

Remove the top alternator mounting bolt (Item 1) and loosen the bottom alternator mounting bolt (Item 2) [Figure 264].

Move the alternator toward the engine as far as it will go and remove the belt from the pulleys. Inspect the pulleys for wear.

Install new belt.

Figure 265

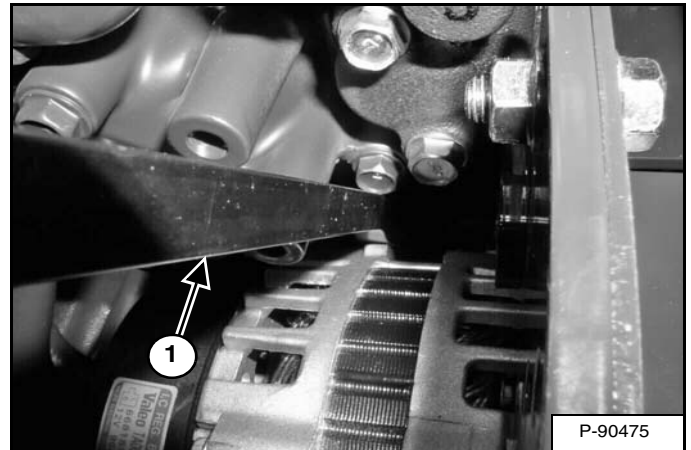

Use a prybar (Item 1) [Figure 265] to move the alternator until the top alternator mounting bolt (Item 1) [Figure 264] can be installed.

Tighten the top and bottom alternator mounting bolts (Items 1 and 2) [Figure 264].

Install the air conditioning belt. (See AIR CONDITIONING BELT on Page 175.)

Install the cable bracket [Figure 261] and the belt shield [Figure 260]. (Earlier models)

OR

Install the throttle bracket [Figure 263] and the throttle cable [Figure 262]. Install a new tie-strap. (Later models)

Close the rear door.

AIR CONDITIONING BELT

This machine may be equipped with Air Conditioning.

Belt Adjustment

The air conditioning belt is a special maintenance free type that is pretensioned over the pulleys. This belt eliminates the need for a tensioning device and does not require periodic adjustment. Contact your Bobcat dealer for replacement parts.

Belt Replacement

Stop the engine and open the rear door. (See REAR DOOR (TAILGATE) on Page 144.)

Figure 266

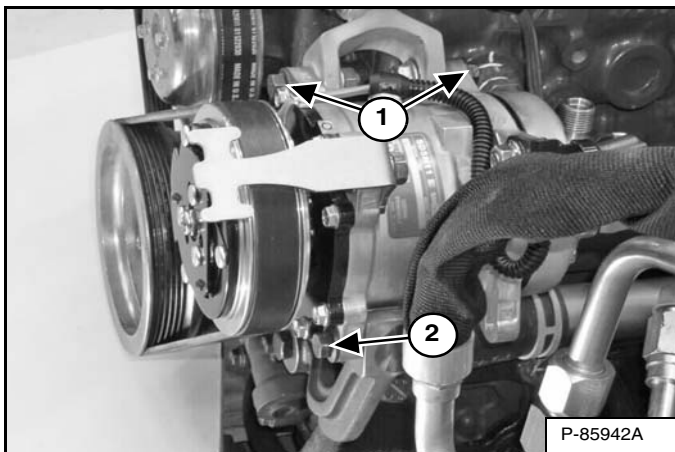

NOTE: The engine is shown removed for visual clarity.

Remove the bottom air conditioning compressor mounting bolt (Item 2) [Figure 266].

Loosen the top air conditioning compressor mounting bolts (Item 1) [Figure 266].

Move the air conditioning compressor toward the engine as far as it will go and remove the belt from the pulleys.

Inspect the pulleys for wear.

Install new belt.

Figure 267

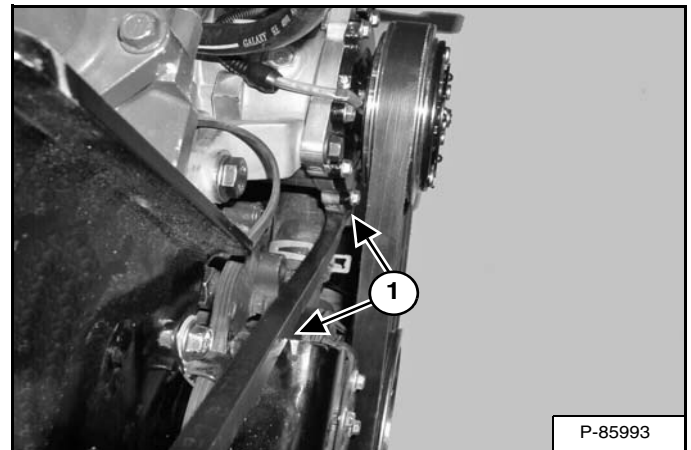

Use a prybar at the two leverage points (Item 1) [Figure 267] to move the air conditioning compressor until the bottom air conditioning compressor mounting bolt (Item 2) [Figure 266] can be installed.

Tighten the three mounting bolts (Items 1 and 2) [Figure 266].

Close the rear door.

DRIVE BELT

Belt Adjustment

The drive belt does not need adjustment. The belt has a spring loaded idler which constantly maintains the correct belt tension.

Stop Adjustment

Stop the engine and open the rear door. (See REAR DOOR (TAILGATE) on Page 144.)

Figure 268

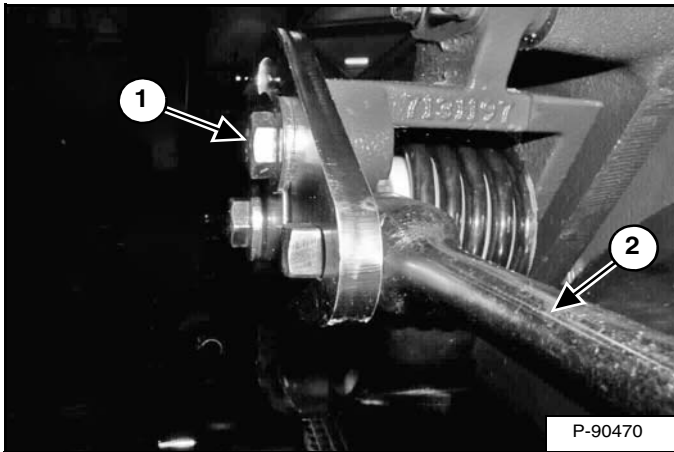

Loosen the spring loaded idler adjustment bolt (Item 1) and insert a 1/2 in. breaker bar (Item 2) [Figure 268] into the slot provided in the stop arm as shown.

Figure 269

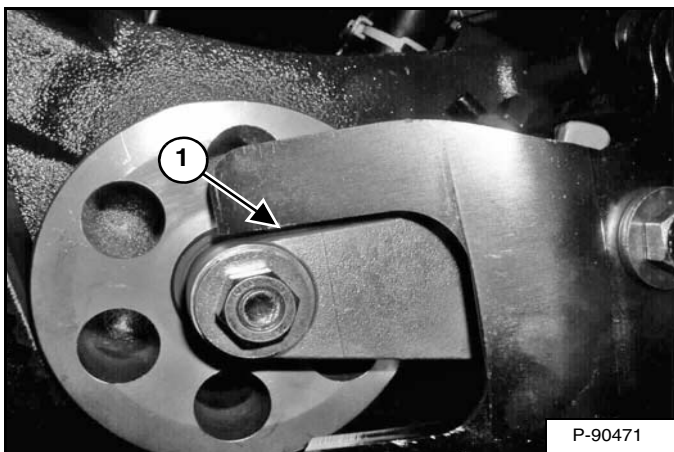

Move the breaker bar to adjust the stop arm until a gap of 3,2 mm (0.125 in) (Item 1) [Figure 269] is achieved.

Tighten the spring loaded idler adjustment bolt (Item 1) [Figure 268] to 105 - 115 N•m (78 - 85 ft-lb) torque.

Belt Replacement

Stop the engine and open the rear door. (See REAR DOOR (TAILGATE) on Page 144.)

Remove the battery. (See Removing And Installing Battery on Page 163.)

Figure 270

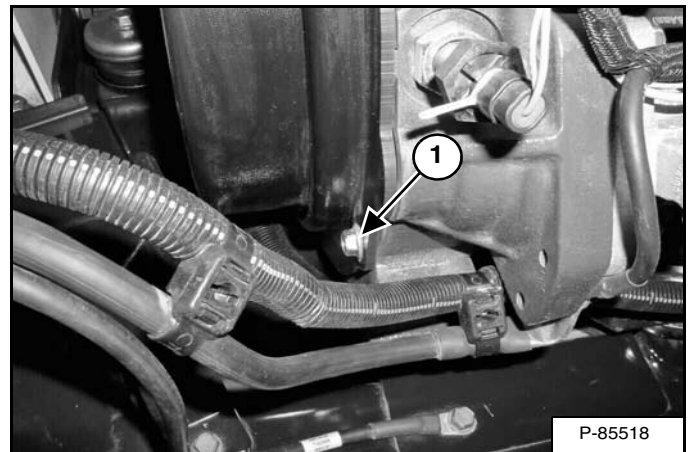

Remove the drive belt shield bolt (Item 1) [Figure 270].

Figure 271

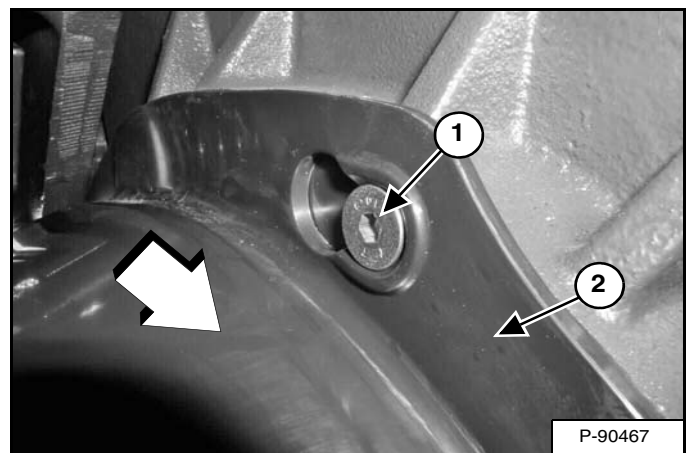

Do **NOT** loosen the drive belt shield mounting bolts (top bolt shown) (Item 1). Slide the drive belt shield (Item 2) toward the back of the loader to unseat the shield from the top and bottom drive belt shield mounting bolts. Remove the drive belt shield (Item 2) [Figure 271].

DRIVE BELT (CONT'D)

Belt Replacement (Cont'd)

Figure 272

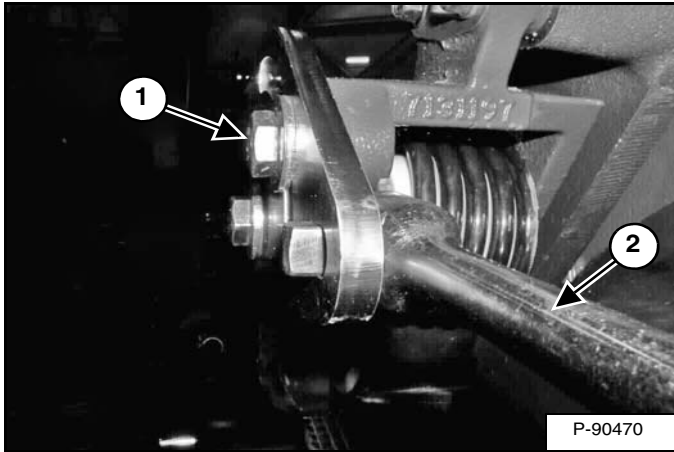

Loosen the spring loaded idler adjustment bolt (Item 1). Insert a 1/2 in. breaker bar (Item 2) [Figure 272] into the slot provided in the stop arm as shown and push breaker bar down to release tension on drive belt.

Tighten the adjustment bolt (Item 1) [Figure 272] to hold the spring loaded idler off the drive belt.

Remove the drive belt from the hydrostatic pump pulley and flywheel pulley. Inspect the pulleys for wear.

Install new drive belt.

Loosen the spring loaded idler adjustment bolt (Item 1) [Figure 272] and allow the idler to contact the drive belt.

Figure 273

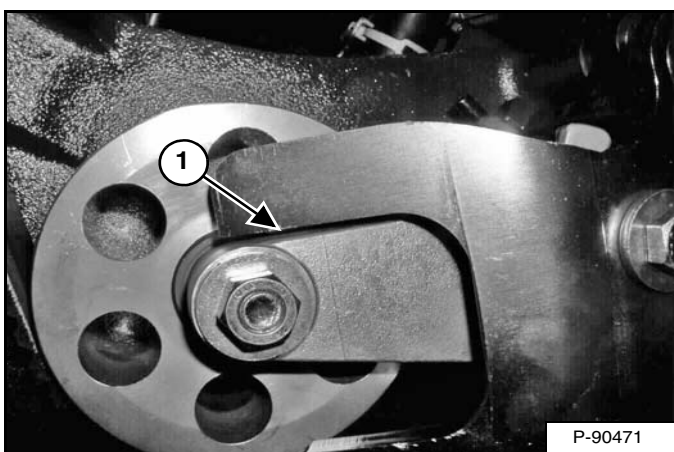

Move the breaker bar to adjust the stop arm until a gap of 3,2 mm (0.125 in) (Item 1) [Figure 273] is achieved.

Tighten the spring loaded idler adjustment bolt (Item 1) [Figure 272] to 105 - 115 N•m (78 - 85 ft-lb) torque.

Figure 274

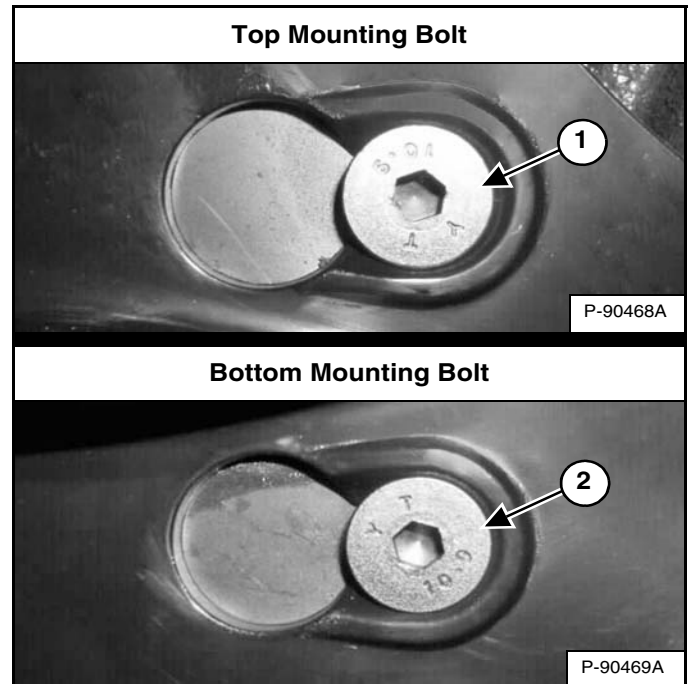

Position the drive belt shield over the drive belt shield mounting bolts and slide the drive belt shield toward the front of the loader to fully seat the shield onto the top and bottom mounting bolts (Items 1 and 2) [Figure 274].

Figure 275

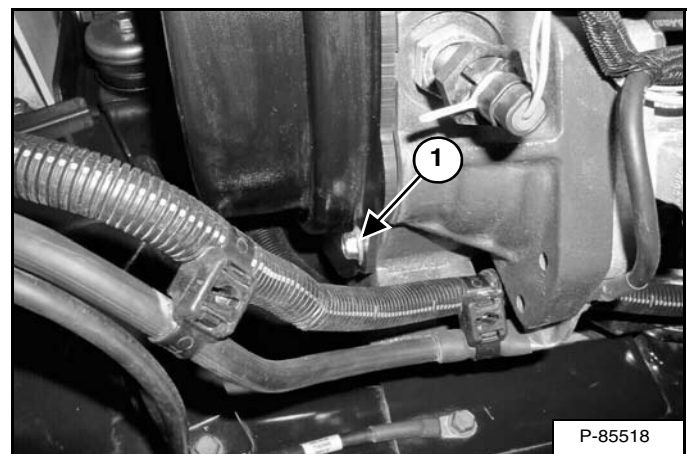

Install the drive belt shield bolt (Item 1) [Figure 275].

Install the battery. (See Removing And Installing Battery on Page 163.)

Close the rear door.

LUBRICATING THE LOADER

Lubrication Locations

Lubricate the loader as specified for the best performance of the loader. (See SERVICE SCHEDULE on Page 131.)

Record the operating hours each time you lubricate the Bobcat loader.

Always use a good quality lithium based multipurpose grease when you lubricate the loader. Apply the lubricant until extra grease shows.

Remove attachment from the loader. (See Installing And Removing The Attachment (Hand Lever Bob-Tach) on Page 103.) **OR** (See Installing And Removing The Attachment (Power Bob-Tach) on Page 105.)

Tilt the Bob-Tach forward until it contacts the ground. (Not required on later models with Bob-Tach wedge grease fittings that are accessible from the side.)

Stop the engine.

Lubricate the following:

Figure 276

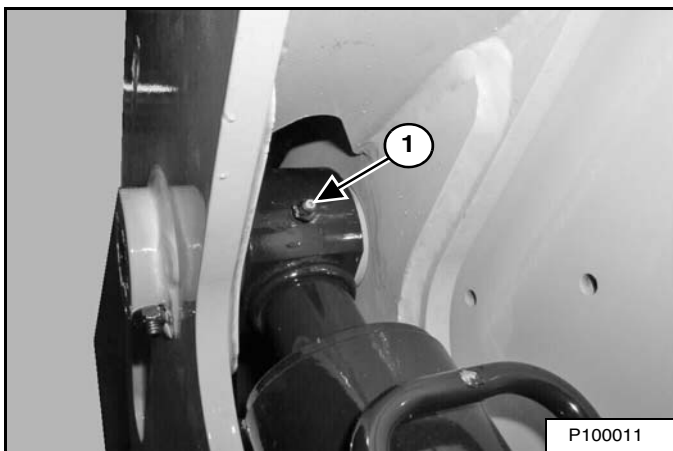

1. Rod End Lift Cylinder (Both Sides) (2) [Figure 276].

Figure 277

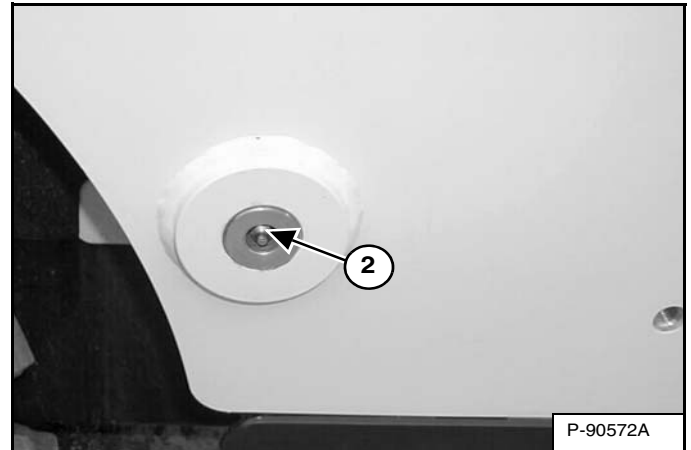

2. Base End Lift Cylinder (Both Sides) (2) [Figure 277].

Figure 278

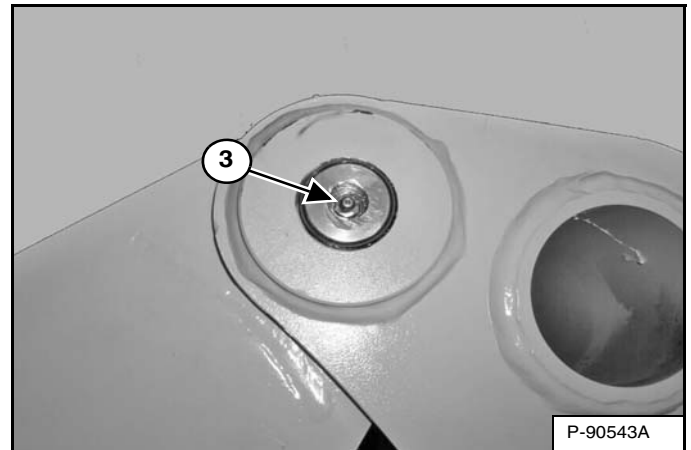

3. Lift Arm Pivot Pin (Both Sides) (2) [Figure 278].

LUBRICATING THE LOADER (CONT'D)

Lubrication Locations (Cont'd)

Figure 279

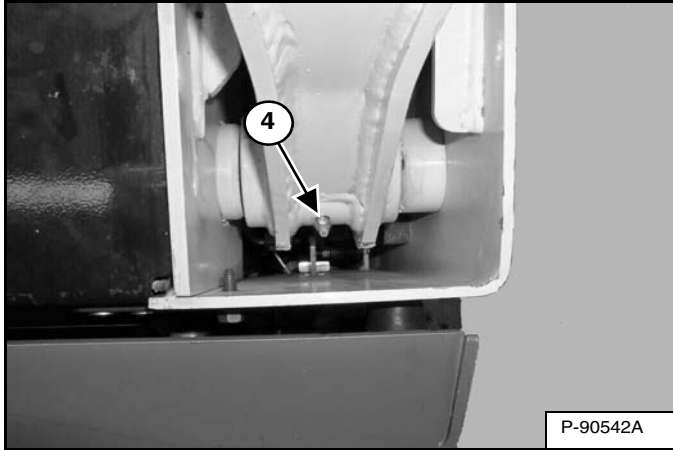

4. Lift Arm Link Pivot (Both Sides) (2) [Figure 279].

Figure 280

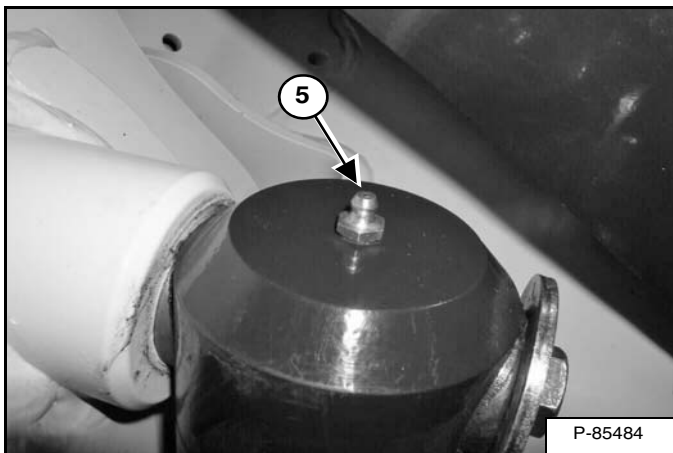

5. Base End Tilt Cylinder (Both Sides) (2) [Figure 280].

Figure 281

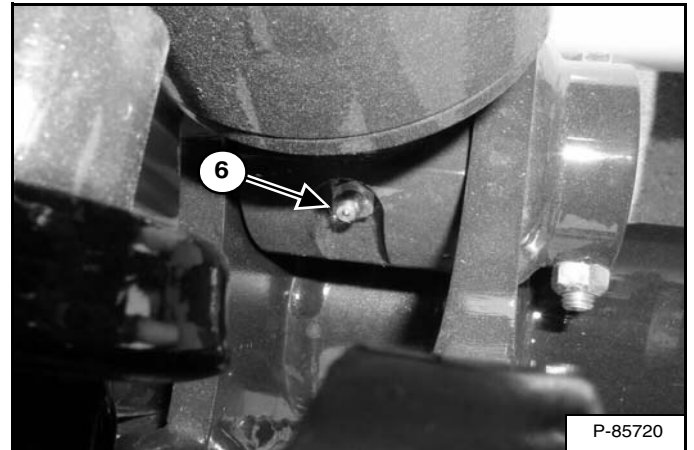

6. Rod End Tilt Cylinder (Both Sides) (2) [Figure 281].

Figure 282

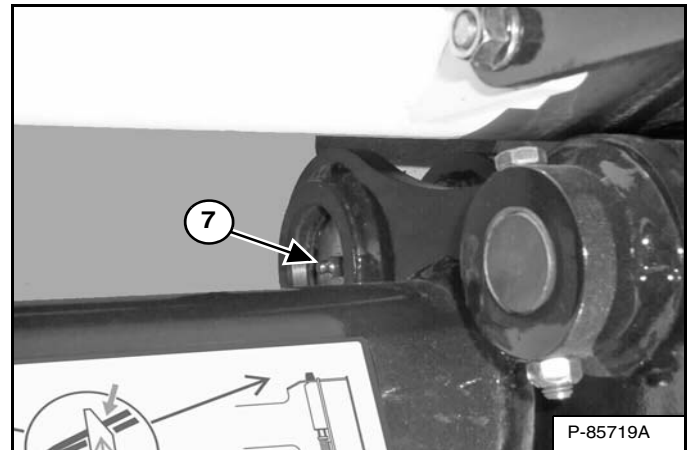

7. Bob-Tach Pivot Pin (Both Sides) (2) [Figure 282].

LUBRICATING THE LOADER (CONT'D)

Lubrication Locations (Cont'd)

Earlier Models

Figure 283

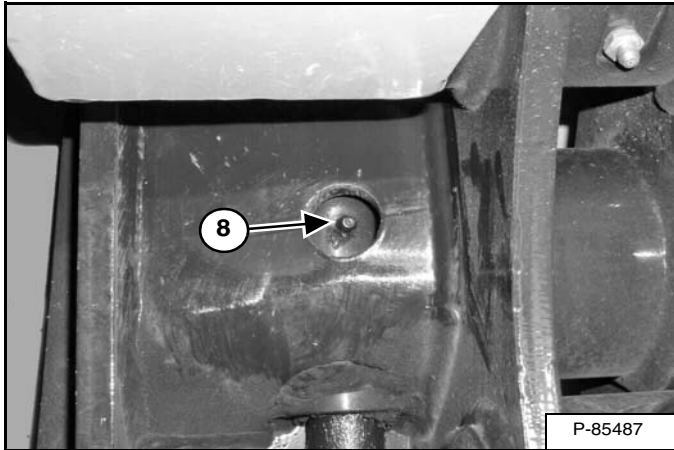

Later Models

Figure 284

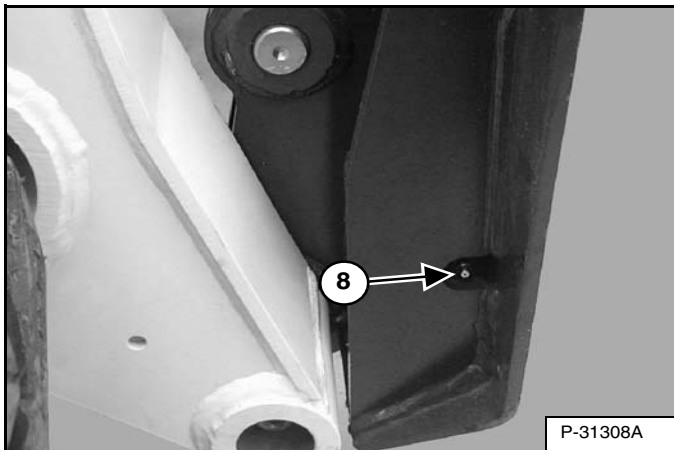

8. Bob-Tach Wedge (Both Sides) (2) [Figure 283] or [Figure 284].

Figure 285

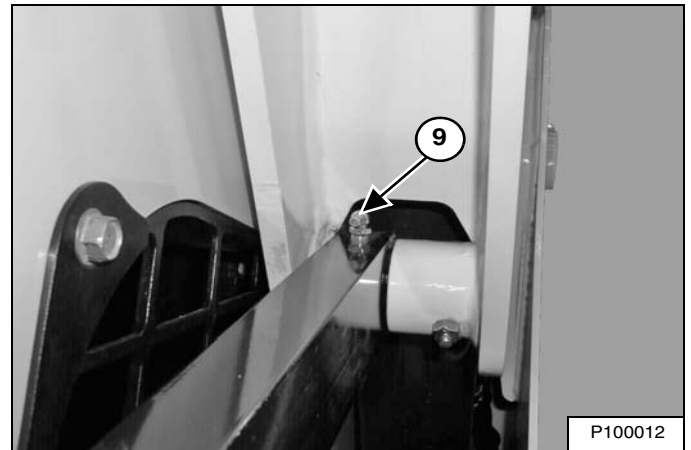

9. Rear Control Link (Both Sides) (2) [Figure 285].

Figure 286

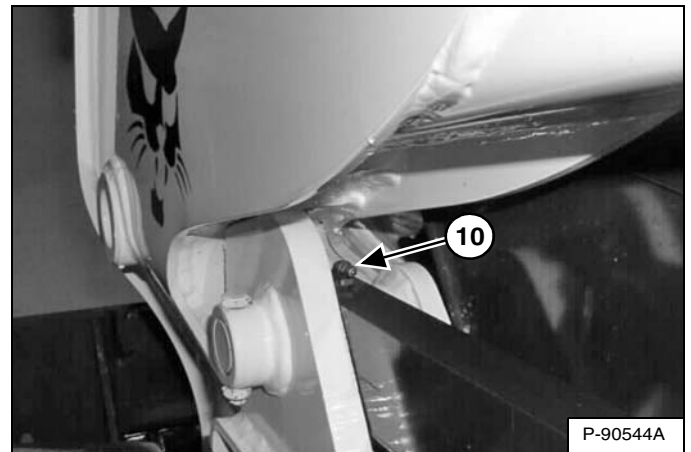

10. Front Control Link (Both Sides) (2) [Figure 286].

PIVOT PINS

Inspection And Maintenance

Figure 287

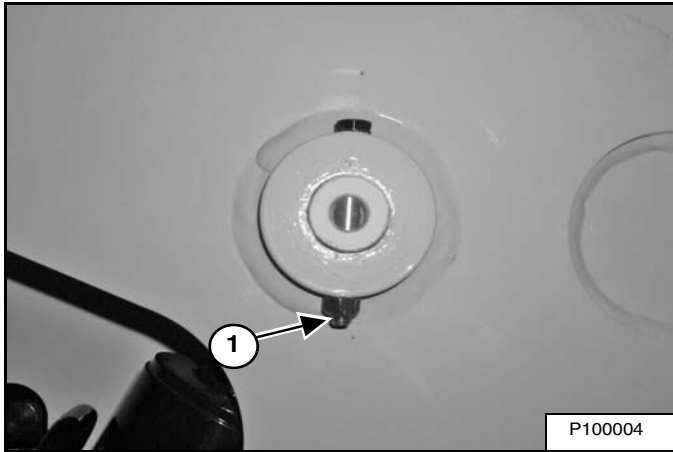

All lift arm and cylinder pivots have a large pin held in position with a retainer bolt and lock nut (Item 1) [Figure 287].

Check that the lock nuts are tightened to 48 - 54 N•m (35 - 40 ft-lb) torque.

BOB-TACH (HAND LEVER)

Inspection And Maintenance

Figure 288

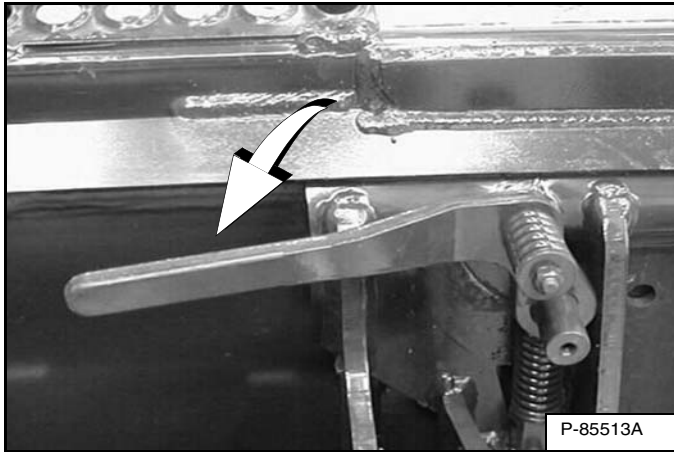

Move the Bob-Tach levers down to engage the wedges [Figure 288].

The levers and wedges must move freely.



AVOID INJURY OR DEATH

The Bob-Tach wedges must extend through the holes in the attachment mounting frame. Levers must be fully down and locked. Failure to secure wedges can allow attachment to come off.

W-2715-0208

Figure 289

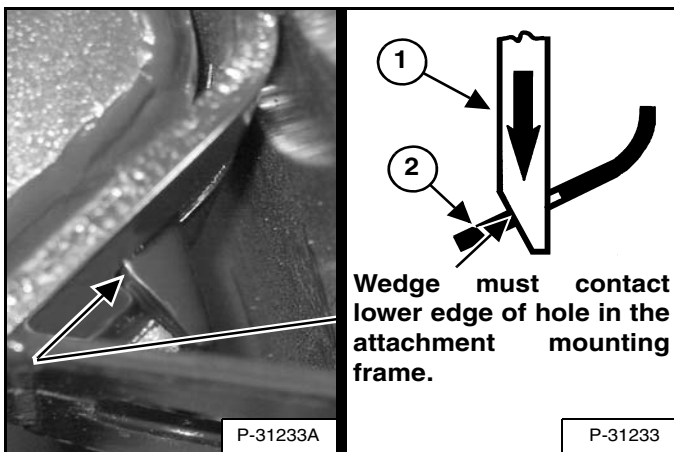

The wedges (Item 1) [Figure 289] must extend through the holes in the attachment mounting frame.

The spring loaded wedges (Item 1) must contact the lower edge of the holes in the attachment mounting frame (Item 2) [Figure 289].

If the wedges do not contact the lower edge of the holes [Figure 289], the attachment will be loose and can come off the Bob-Tach.

Figure 290

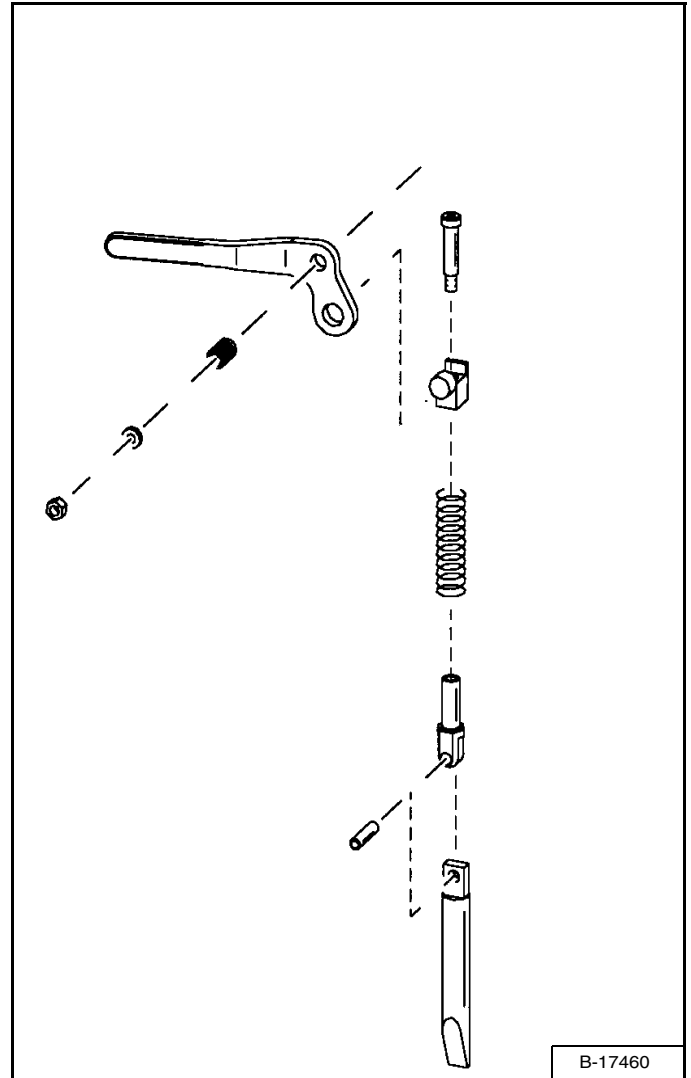

Inspect the mounting frame on the attachment and Bob-Tach, linkages and wedges for excessive wear or damage [Figure 290]. Replace any parts that are damaged, bent or missing. Keep all fasteners tight.

Look for cracked welds. Contact your Bobcat dealer for repair or replacement parts.

Lubricate the wedges. (See SERVICE SCHEDULE on Page 131.) and (See LUBRICATING THE LOADER on Page 178.)

BOB-TACH (POWER)

This machine may be equipped with a Power Bob-Tach.

Inspection And Maintenance

Figure 291

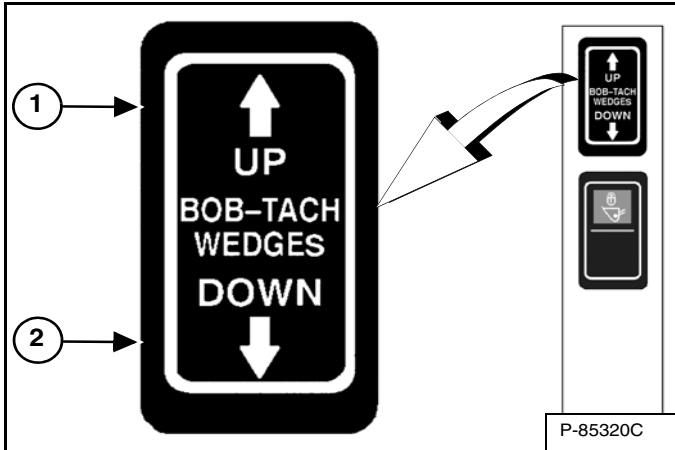

Push and hold the BOB-TACH “WEDGES UP” switch (Item 1) until wedges are fully raised. Push and hold the BOB-TACH “WEDGES DOWN” switch (Item 2) [Figure 291] until the wedges are fully down.

The levers and wedges must move freely.



AVOID INJURY OR DEATH

The Bob-Tach wedges must extend through the holes in the attachment mounting frame. Levers must be fully down and locked. Failure to secure wedges can allow attachment to come off.

W-2715-0208

Figure 292

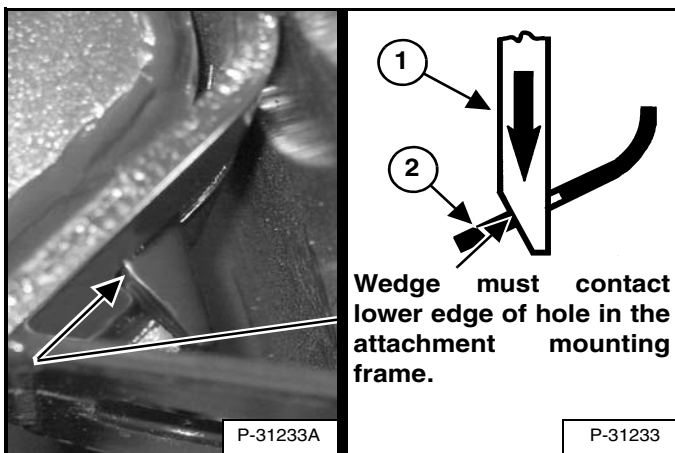

The wedges (Item 1) [Figure 292] must extend through the holes in the attachment mounting frame.

The spring loaded wedges (Item 1) must contact the lower edge of the holes in the attachment mounting frame (Item 2) [Figure 292].

If the wedges do not contact the lower edge of the holes [Figure 292], the attachment will be loose and can come off the Bob-Tach.

Figure 293

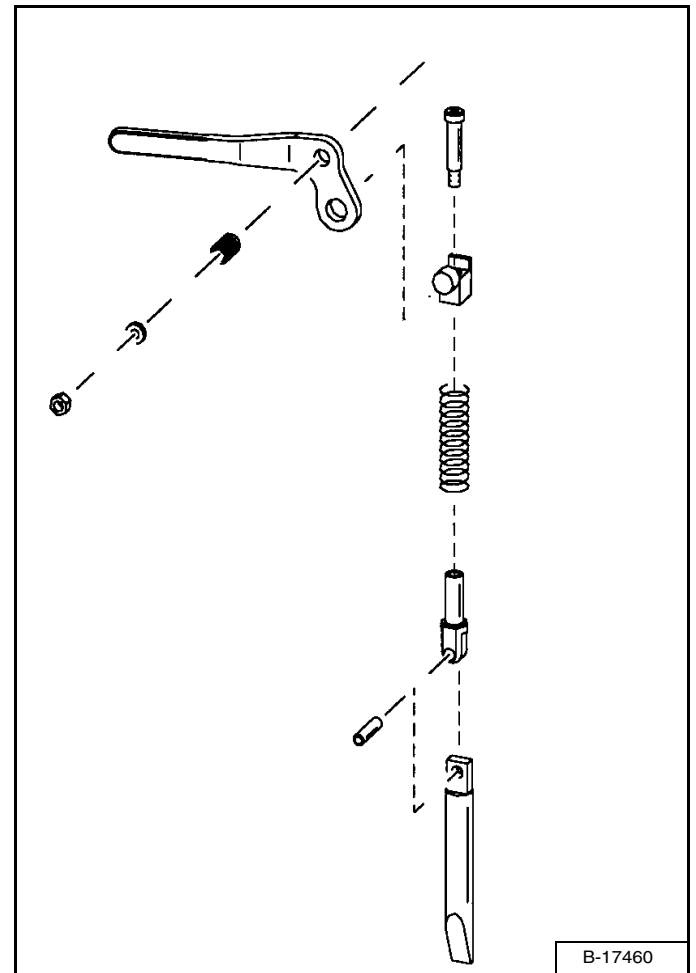

Inspect the mounting frame on the attachment and Bob-Tach, linkages and wedges for excessive wear or damage [Figure 293]. Replace any parts that are damaged, bent or missing. Keep all fasteners tight.

Look for cracked welds. Contact your Bobcat dealer for repair or replacement parts.

Lubricate the wedges. (See SERVICE SCHEDULE on Page 131.) and (See LUBRICATING THE LOADER on Page 178.)



LOADER STORAGE AND RETURN TO SERVICE

Storage

Sometimes it may be necessary to store your Bobcat loader for an extend period of time. Below is a list of items to perform before storage.

- Thoroughly clean the loader including the engine compartment.
- Lubricate the loader.
- Replace worn or damaged parts.
- Park the loader in a dry protected shelter.
- Lower the lift arms all the way and put the bucket flat on the ground.
- Put blocks under the frame to remove weight from the tyres.
- Put grease on any exposed cylinder rods.
- Put fuel stabiliser in the fuel tank and run the engine a few minutes to circulate the stabiliser to the pump and fuel injectors.

If biodiesel blend fuel has been used, perform the following:

Drain the fuel tank, refill with 100% petroleum diesel fuel, add fuel stabiliser and run the engine for at least 30 minutes.

- Drain and flush the cooling system. Refill with premixed coolant.
- Replace all fluids and filters (engine, hydraulic / hydrostatic).
- Replace air cleaner, heater and air conditioning filters.
- Put all controls in neutral position.
- Remove the battery. Be sure the electrolyte level is correct then charge the battery. Store it in a cool dry place above freezing temperatures and charge it periodically during storage.
- Cover the exhaust pipe opening.
- Tag the machine to indicate that it is in storage condition.

Return To Service

After the Bobcat loader has been in storage, it is necessary to follow a list of items to return the loader to service.

- Check the engine and hydraulic oil levels; check coolant level.
- Install a fully charged battery.
- Remove grease from exposed cylinder rods.
- Check all belt tensions.
- Be sure all shields and guards are in place.
- Lubricate the loader.
- Check tyre inflation and remove blocks from under frame.
- Remove cover from exhaust pipe opening.
- Start the engine and let run for a few minutes while observing the instrument panels and systems for correct operation.
- Operate machine, check for correct function.
- Stop the engine and check for leaks. Repair as needed.



SYSTEM SETUP & ANALYSIS

DIAGNOSTIC SERVICE CODES	187
Viewing Service Codes	187
Service Codes List	188
CONTROL PANEL SETUP	193
Right Panel Setup (Deluxe Instrumentation Panel)	193
PASSWORD SETUP (KEYLESS START PANEL)	195
Password Description	195
Changing The Owner Password	195
Password Lockout Feature	195
PASSWORD SETUP (DELUXE INSTRUMENTATION PANEL)	196
Password Description	196
Changing The Owner Password	196
Changing The User Passwords	197
Password Lockout Feature	197
MAINTENANCE CLOCK	198
Description	198
Setup	198
Reset	198



Bobcat®



DIAGNOSTIC SERVICE CODES

Viewing Service Codes

The Service Codes will aid your dealer in diagnosing conditions which can damage your machine.

Figure 294

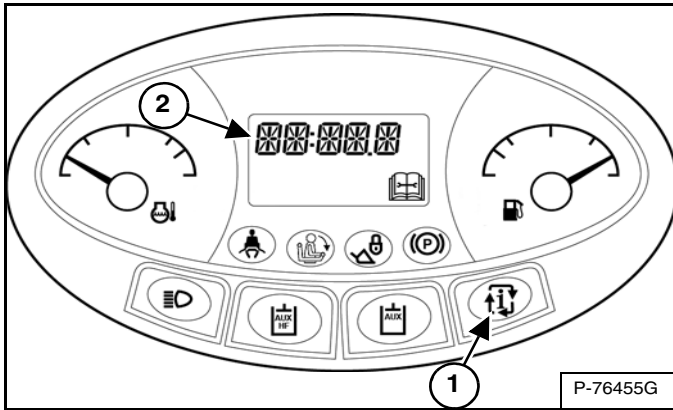

Press the INFORMATION button (Item 1) to cycle the DATA DISPLAY (Item 2) [Figure 294] until the service code screen is displayed. If more than one SERVICE CODE is present, the codes will scroll on the DATA DISPLAY.

NOTE: Corroded or loose earths can cause multiple service codes and / or abnormal symptoms. All instrument panel lights flashing, alarm sounding, headlights and taillights flashing, could indicate a bad earth. The same symptoms could apply if the voltage is low, such as loose or corroded battery cables. If you observe these symptoms, check earths and positive leads first.

Deluxe Instrumentation Panel

The optional Deluxe Instrumentation Panel offers an additional view of service codes that includes a brief description.

The last 40 codes stored in history can also be viewed using the Deluxe Instrumentation Panel.

Figure 295

Press a scroll button (Item 1) repeatedly until the Active Warnings screen icon (Inset) is highlighted.

The ACTIVE WARNINGS screen displays active service codes. Press [9] to view the next service code if more than one is present. Press [4] to display a history of service codes.

The WARNINGS HISTORY screen will list the Service Code Number (CODE), Hourmeter reading when the error occurred (HOUR), and the User (USER) who was logged in to operate the machine when the error occurred.

Press [9] to view the next eight Service Codes.

A total of 40 Codes can be stored. When more than 40 codes occur, the oldest code will disappear and the newest code will be in the number 1 position.

Press the list number next to the service code for more detail.

Press left scroll button to back up one screen.

P-90378 / NA3025A / NA3000 / NA3038 / NA3035



DIAGNOSTIC SERVICE CODES (CONT'D)

Service Codes List

Figure 296

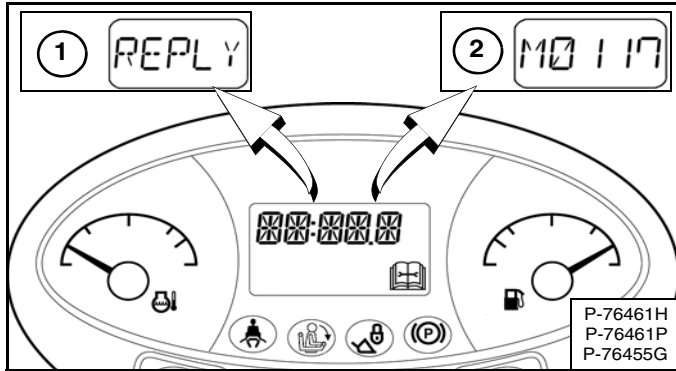

Service Codes may be either a word (Item 1) or a number (Item 2) [Figure 296].

The following word errors may be displayed:

[REPLY] One or both instrument panel(s) not communicating with the controller.

[CODE] The controller is asking for a password. (Keyless Start and Deluxe Instrumentation Panels only.)

[ERROR] The wrong password was entered. (Keyless Start and Deluxe Instrumentation Panels only.)

[SHTDN] A shutdown condition exists.

[DOOR] Operator cab door is open. (Lift and Tilt functions will not operate.)

CODE	DESCRIPTION	CODE	DESCRIPTION
A3623	ACD not programmed	A8503	ACD output 'F' error OFF
A8002	ACD output 'A' error ON	A8505	ACD output 'F' short to battery
A8003	ACD output 'A' error OFF	A8506	ACD output 'F' short to earth
A8005	ACD output 'A' short to battery	A8507	ACD output 'F' open circuit
A8006	ACD output 'A' short to earth	A8532	ACD output 'F' overcurrent
A8007	ACD output 'A' open circuit	A8602	ACD output 'G' error ON
A8032	ACD output 'A' overcurrent	A8603	ACD output 'G' error OFF
A8102	ACD output 'B' error ON	A8605	ACD output 'G' short to battery
A8103	ACD output 'B' error OFF	A8606	ACD output 'G' short to earth
A8105	ACD output 'B' short to battery	A8607	ACD output 'G' open circuit
A8106	ACD output 'B' short to earth	A8702	ACD output 'H' error ON
A8107	ACD output 'B' open circuit	A8703	ACD output 'H' error OFF
A8132	ACD output 'B' overcurrent	A8705	ACD output 'H' short to battery
A8202	ACD output 'C' error ON	A8706	ACD output 'H' short to earth
A8203	ACD output 'C' error OFF	A8707	ACD output 'H' open circuit
A8205	ACD output 'C' short to battery		
A8206	ACD output 'C' short to earth	D3905	Left joystick X-axis not in neutral
A8207	ACD output 'C' open circuit	D3907	Left joystick Y-axis not in neutral
A8232	ACD output 'C' overcurrent	D4007	Right joystick Y-axis not in neutral
A8302	ACD output 'D' error ON	D7501	CAN joystick communication error
A8303	ACD output 'D' error OFF	D7504	No communication from drive controller
A8305	ACD output 'D' short to battery	D7505	Left joystick X-axis not in neutral
A8306	ACD output 'D' short to earth	D7507	Left joystick Y-axis not in neutral
A8307	ACD output 'D' open circuit	D7508	Right joystick Y-axis not in neutral
A8332	ACD output 'D' overcurrent	D7509	Operating mode switch short to earth or battery
A8402	ACD output 'E' error ON	D7513	Right front wheel angle sensor unresponsive
A8403	ACD output 'E' error OFF	D7514	Left front wheel angle sensor unresponsive
A8405	ACD output 'E' short to battery	D7515	Right rear wheel angle sensor unresponsive
A8406	ACD output 'E' short to earth	D7516	Left rear wheel angle sensor unresponsive
A8407	ACD output 'E' open circuit	D7517	Left swash plate not in neutral
A8432	ACD output 'E' overcurrent	D7518	Right swash plate not in neutral
A8502	ACD output 'F' error ON	D7519	Left joystick X-axis out of range high



DIAGNOSTIC SERVICE CODES (CONT'D)

Service Codes List (Cont'd)

CODE	DESCRIPTION	CODE	DESCRIPTION
D7521	Left joystick Y-axis out of range high	D7572	Drive pump not calibrated
D7522	Right joystick Y-axis out of range high	D7573	Operating mode switch flipped while operating
D7523	Right front wheel angle sensor out of range high	D7574	Right wheel speed uncommanded motion
D7524	Left front wheel angle sensor out of range high	D7575	Left wheel speed uncommanded motion
D7525	Right rear wheel angle sensor out of range high	D7576	No communication from ACS controller
D7526	Left rear wheel angle sensor out of range high	D7577	Left speed sensor out of range high
D7527	Left swash plate out of position	D7578	Right speed sensor out of range high
D7528	Right swash plate out of position	D7579	Left speed sensor out of range low
D7529	Left joystick X-axis out of range low	D7580	Right speed sensor out of range low
D7531	Left joystick Y-axis out of range low	D7581	Right front steer retract short to battery
D7532	Right joystick Y-axis out of range low	D7582	Left front steer retract short to battery
D7533	Right front wheel angle sensor out of range low	D7583	Right rear steer retract short to battery
D7534	Left front wheel angle sensor out of range low	D7584	Left rear steer retract short to battery
D7535	Right rear wheel angle sensor out of range low	D7585	Sensor supply 1 out of range high
D7536	Left rear wheel angle sensor out of range low	D7586	Sensor supply 2 out of range high
D7537	Sensor supply 1 out of range low	D7587	Software update required
D7538	Sensor supply 2 out of range low	D7588	Switched power stuck ON
D7539	Left swash plate sensor out of range high	D7589	Switched power error OFF
D7540	Left swash plate sensor out of range low	D7591	Left swash plate sensor reversed
D7541	Right swash plate sensor out of range high	D7592	Right swash plate sensor reversed
D7542	Right swash plate sensor out of range low	D7593	Right speed sensor unresponsive
D7543	Left forward drive solenoid error ON	D7594	Left speed sensor unresponsive
D7544	Left reverse drive solenoid error ON	D7595	Left speed sensor reversed
D7545	Right forward drive solenoid error ON	D7596	Right speed sensor reversed
D7546	Right reverse drive solenoid error ON	D7597	Controller programmed
D7547	Right front steer extend short to battery	D7598	In drive calibration mode
D7548	Left front steer extend short to battery	D7599	In angle calibration mode
D7549	Right rear steer extend short to battery		
D7550	Left rear steer extend short to battery	H1221	Right Primary out of range high
D7551	Steer pressure short to battery	H1222	Right Primary out of range low
D7552	Back-up alarm error ON	H1224	Right Primary not in neutral
D7553	Left forward drive solenoid error OFF	H1321	Left Primary out of range high
D7554	Left reverse drive solenoid error OFF	H1322	Left Primary out of range low
D7555	Right forward drive solenoid error OFF	H1324	Left Primary not in neutral
D7556	Right reverse drive solenoid error OFF	H2005	Boost solenoid short to battery
D7557	Right front steer extend short to earth	H2006	Boost solenoid short to earth
D7558	Right front steer retract short to earth	H2007	Boost solenoid open circuit
D7559	Left front steer extend short to earth	H2032	Boost solenoid overcurrent
D7560	Left front steer retract short to earth	H2205	Pressure control solenoid short to battery
D7561	Right rear steer extend short to earth	H2206	Pressure control solenoid short to earth
D7562	Right rear steer retract short to earth	H2207	Pressure control solenoid open circuit
D7563	Left rear steer extend short to earth	H2232	Pressure control solenoid overcurrent
D7564	Left rear steer retract short to earth	H2305	Rear base solenoid short to battery
D7565	Steer pressure short to earth	H2306	Rear base solenoid short to earth
D7566	Back-up alarm error OFF	H2307	Rear base solenoid open circuit
D7567	No communication from Gateway controller	H2332	Rear base solenoid overcurrent
D7568	Angle sensors not calibrated	H2405	Rear rod solenoid short to battery
D7569	Battery voltage out of range high	H2406	Rear rod solenoid short to earth
D7570	Interrupted power	H2407	Rear rod solenoid open circuit
D7571	Battery voltage out of range low	H2432	Rear rod solenoid overcurrent



DIAGNOSTIC SERVICE CODES (CONT'D)

Service Codes List (Cont'd)

CODE	DESCRIPTION	CODE	DESCRIPTION
H2505	Rear aux relief short to battery	M0116	Air filter not connected
H2506	Rear aux relief short to earth	M0117	Air filter plugged
H2507	Rear aux relief open circuit	M0216	Hydraulic/Hydrostatic filter not connected
H2605	Front base solenoid short to battery	M0217	Hydraulic/Hydrostatic filter plugged
H2606	Front base solenoid short to earth	M0309	Battery voltage low
H2607	Front base solenoid open circuit	M0310	Battery voltage high
H2632	Front base solenoid overcurrent	M0311	Battery voltage extremely high
H2705	Front rod solenoid short to battery	M0314	Battery voltage extremely low
H2706	Front rod solenoid short to earth	M0322	Battery voltage out of range low
H2707	Front rod solenoid open circuit	M0409	Engine oil pressure low
H2732	Front rod solenoid overcurrent	M0414	Engine oil pressure extremely low
H2805	Diverter rod solenoid short to battery	M0415	Engine oil pressure shutdown
H2806	Diverter rod solenoid short to earth	M0421	Engine oil pressure out of range high
H2807	Diverter rod solenoid open circuit	M0422	Engine oil pressure out of range low
H2905	High-flow solenoid short to battery	M0509	Hydraulic charge pressure low
H2906	High-flow solenoid short to earth	M0510	Hydraulic charge pressure high
H2907	High-flow solenoid open circuit	M0511	Hydraulic charge pressure extremely high
H2932	High-flow solenoid overcurrent	M0514	Hydraulic charge pressure extremely low
H3028	Controller memory failure	M0515	Hydraulic charge pressure shutdown
H3128	Interrupted power failure	M0521	Hydraulic charge pressure out of range high
H3648	ACD multiple	M0522	Hydraulic charge pressure out of range low
H3913	Left joystick grip no communication	M0610	Engine speed high
H3916	Left joystick not connected	M0611	Engine speed extremely high
H3928	Left joystick failure	M0613	Engine speed no signal
H3948	Left joystick multiple	M0615	Engine speed shutdown
H4013	Right joystick grip no communication	M0618	Engine speed out of range
H4016	Right joystick not connected	M0710	Hydraulic oil temperature high
H4028	Right joystick failure	M0711	Hydraulic oil temperature extremely high
H4048	Right joystick multiple	M0715	Hydraulic oil temperature shutdown
H4302	Horn error ON	M0721	Hydraulic oil temperature out of range high
H4303	Horn error OFF	M0722	Hydraulic oil temperature out of range low
H4423	Auxiliary not programmed	M0810	Engine coolant temperature high
H4502	Right signal error ON	M0811	Engine coolant temperature extremely high
H4503	Right signal error OFF	M0815	Engine coolant temperature shutdown
H4602	Left signal error ON	M0821	Engine coolant temperature out of range high
H4603	Left signal error OFF	M0822	Engine coolant temperature out of range low
H4721	Sensor supply 1 out of range high	M0909	Fuel level low
H4722	Sensor supply 1 out of range low	M0921	Fuel level out of range high
H7314	Remote control failure	M0922	Fuel level out of range low
H7328	Remote control no signal	M1016	Hydraulic charge filter not connected
H7404	Main controller no communication	M1017	Hydraulic charge filter plugged
H7604	Left hand panel no communication	M1121	Seat bar sensor out of range high
		M1122	Seat bar sensor out of range low
L0102	Left panel button 1 error ON	M1305	Fuel hold solenoid short to battery
L0202	Left panel button 2 error ON	M1306	Fuel hold solenoid short to earth
L0302	Left panel button 3 error ON	M1307	Fuel hold solenoid open circuit
L0402	Left panel button 4 error ON	M1402	Fuel pull output error ON
L7404	Left panel main controller no communication	M1403	Fuel pull output error OFF
L7672	Left panel programming error	M1407	Fuel pull output open circuit
		M1428	Fuel pull output failure



DIAGNOSTIC SERVICE CODES (CONT'D)

Service Codes List (Cont'd)

CODE	DESCRIPTION	CODE	DESCRIPTION
M1502	Traction lock pull output error ON	M3805	Auxiliary hydraulic lock short to battery
M1503	Traction lock pull output error OFF	M3806	Auxiliary hydraulic lock short to earth
M1507	Traction lock pull output open circuit	M3807	Auxiliary hydraulic lock open circuit
M1528	Traction lock pull output failure	M3832	Auxiliary hydraulic lock overcurrent
M1605	Traction lock hold solenoid short to battery	M4109	Alternator low
M1606	Traction lock hold solenoid short to earth	M4110	Alternator high
M1607	Traction lock hold solenoid open circuit	M4304	Keyless panel no communication
M1705	Hydraulic lock valve solenoid short to battery	M4404	Auxiliary no communication
M1706	Hydraulic lock valve solenoid short to earth	M4621	5 volt sensor supply out of range high
M1707	Hydraulic lock valve solenoid open circuit	M4622	5 volt sensor supply out of range low
M1732	Hydraulic lock valve solenoid overcurrent	M4721	8 volt sensor supply out of range high
M1805	Lift spool lock short to battery	M4722	8 volt sensor supply out of range low
M1806	Lift spool lock short to earth	M4802	Front light relay error ON
M1807	Lift spool lock open circuit	M4803	Front light relay error OFF
M1832	Lift spool lock overcurrent	M4807	Front light relay open circuit
M2005	Two-speed primary short to battery	M4902	Rear light relay error ON
M2006	Two-speed primary short to earth	M4903	Rear light relay error OFF
M2007	Two-speed primary open circuit	M4907	Rear light relay open circuit
M2032	Two-speed primary overcurrent	M5002	Front light output error ON
M2102	Glow plug output error ON	M5003	Front light output error OFF
M2103	Glow plug output error OFF	M5007	Front light output open circuit
M2107	Glow plug output open circuit	M5028	Front light output failure
M2128	Glow plug output failure	M5102	Rear light output error ON
M2202	Starter output error ON	M5103	Rear light output error OFF
M2203	Starter output error OFF	M5107	Rear light output open circuit
M2207	Starter output open circuit	M5128	Rear light output failure
M2228	Starter output failure	M5202	PTOL switch error ON
M2302	Starter relay error ON	M5221	PTOL switch out of range high
M2303	Starter relay error OFF	M5222	PTOL switch out of range low
M2402	Fuel pull relay error ON	M5305	PTOL LED short to battery
M2403	Fuel pull relay error OFF	M5306	PTOL LED short to earth
M2502	Traction pull relay error ON	M5405	Tilt spool lock short to battery
M2503	Traction pull relay error OFF	M5406	Tilt spool lock short to earth
M2602	Glow plug relay error ON	M5407	Tilt spool lock open circuit
M2603	Glow plug relay error OFF	M5432	Tilt spool lock overcurrent
M2721	Throttle primary out of range high	M6402	Switched power relay error ON
M2722	Throttle primary out of range low	M6403	Switched power relay error OFF
M2821	Throttle secondary out of range high	M6505	EEC power short to battery
M2822	Throttle secondary out of range low	M6506	EEC power short to earth
M3128	Interrupted power failure	M6507	EEC power open circuit
M3204	Workgroup no communication	M6604	EEC power no communications
M3304	Deluxe panel no communication	M7002	Switched power output error ON
M3505	Hydraulic fan short to battery	M7003	Switched power output error OFF
M3506	Hydraulic fan short to earth	M7007	Switched power output open circuit
M3507	Hydraulic fan open circuit	M7028	Switched power output failure
M3532	Hydraulic fan overcurrent	M7102	Electric fan 1 output error ON
M3705	Two-speed secondary short to battery	M7103	Electric fan 1 output error OFF
M3706	Two-speed secondary short to earth	M7128	Electric fan 1 output failure
M3707	Two-speed secondary open circuit	M7202	Electric fan 1 relay error ON
M3732	Two-speed secondary overcurrent	M7203	Electric fan 1 relay error OFF



DIAGNOSTIC SERVICE CODES (CONT'D)

Service Codes List (Cont'd)

CODE	DESCRIPTION	CODE	DESCRIPTION
M7207	Electric fan 1 relay open circuit	W3251	Lift actuator short to battery
M7304	Remote control no communication	W3252	Tilt actuator short to battery
M7316	Remote control no signal from transmitter	W3253	Lift handle / pedal short to earth
M7423	Main controller not programmed	W3254	Tilt handle / pedal short to earth
M7472	Main controller in boot code	W3255	Lift handle / pedal short to battery
M7497	Main controller software updated	W3256	Tilt handle / pedal short to battery
M7504	Drive no communication	W3257	Lift actuator reduced performance
M7604	Left display panel no communication	W3258	Tilt actuator reduced performance
M7748	Key switch multiple	W3259	Lift actuator wrong direction
M7839	Hourmeter changed	W3260	Tilt actuator wrong direction
M7974	Door open	W3261	Handle lock short to earth
		W3262	Handle lock short to battery
W3223	ACS calibration required	W3263	Pedal lock short to earth
W3224	ACS calibration failed	W3264	Pedal lock short to battery
W3231	Tilt actuator fault	W3265	Sensor supply voltage out of range
W3232	Tilt actuator wiring fault	W3266	Battery voltage out of range
W3233	Tilt handle wiring fault	W3267	Handle/pedal switch flipped while operating
W3234	Tilt actuator not in neutral	W3268	Lift handle information error
W3235	Tilt handle / pedal not in neutral	W3270	Right hand drive short to earth
W3236	Lift actuator fault	W3271	Right hand drive short to battery
W3237	Lift actuator wiring fault	W3274	Left joystick X-axis out of range
W3238	Lift handle wiring fault	W3275	Interrupted unswitched power
W3239	Lift actuator not in neutral	W3276	CAN joystick information error
W3240	Lift handle / pedal not in neutral	W3277	Remote control information error
W3241	No communication	W3905	Left joystick X-axis not in neutral
W3249	Lift actuator short to earth	W4005	Right joystick X-axis not in neutral
W3250	Tilt actuator short to earth	W4007	Right joystick Y-axis not in neutral



CONTROL PANEL SETUP

Right Panel Setup (Deluxe Instrumentation Panel)

Icon Identification

Figure 297



ICON	DESCRIPTION
Mon, 17 Mar 3:45 PM	DATE / TIME
BRADY 232.5 hrs	USER / HOURMETER
Current Job 456.7 hrs	CURRENT JOB HOURS
	ACTIVE WARNINGS screen icon
	VITALS screen icon
	SERVICE screen icon
	MAIN screen icon
	ATTACHMENTS screen icon
	SECURITY screen icon
	DISPLAY screen icon
	LEFT SCROLL button
	RIGHT SCROLL button
ENTER	ENTER button

Example

Languages

Figure 298

Press a scroll button (Item 1) repeatedly until the Display screen icon (Inset) is highlighted.

Select [2. LANGUAGES].

Select the desired language.

P-90385 / NA3025A / NA3012 / NA3023



CONTROL PANEL SETUP (CONT'D)

Right Panel Setup (Deluxe Instrumentation Panel) (Cont'd)

More Examples

Clocks

Select ...

DISPLAY screen icon
[1. CLOCKS]

SET TIME AND DATE

Select [1. TIME]
Use the keypad to enter date.
Press ENTER to continue.
Use the keypad to enter time.
Select AM / PM / 24hr.
Press ENTER to continue.

RESET JOB CLOCK

(Owner password required if Job Clock is locked.)
Select [2. JOB CLOCK]
Press [4] to cycle between lock and unlock.
Press [9] to reset.

SET ALARM

Select [3. ALARM CLOCK]
Select alarm 1, 2 or 3.
Press [1] to cycle between ON and OFF.
Press [2] and use the keypad to enter alarm time.
Select AM / PM / 24hr.
Press ENTER to continue.
Press [3] to cycle between ONCE, DAILY and WEEKLY.
Selecting WEEKLY will prompt for a day selection using number [4].
Press ENTER to continue.

Vitals (Monitor the engine, hydraulic / hydrostatic, electrical functions when engine is running.)

Select ...

VITALS screen icon
Press [6] to cycle between METRIC or ENGLISH (M / E) readouts.

You can monitor real-time readouts of:

- Engine Speed**
- Engine Oil Pressure**
- Engine Coolant Temperature**
- System Voltage**
- Hydraulic Charge Pressure**
- Hydraulic Oil Temperature**

The Deluxe Instrumentation Panel is easy to use. Continue to set your own preferences for running / monitoring your Bobcat loader.



PASSWORD SETUP (KEYLESS START PANEL)

Password Description

Master Password:

A permanent, randomly selected password set at the factory which cannot be changed. This password is used for service by the Bobcat dealer if the owner password is not known; or to change the owner password.

Owner Password:

Allows for full use of the loader. It must be used to change the owner password.

Changing The Owner Password

Turn the key switch to the RUN position to turn on the loaders electrical system.

Enter the five digit owner password using the number keys (1 through 0) if locked.

Figure 299



Press and hold the lock (Item 1) and unlock (Item 2) [Figure 299] keys for two seconds.

The lock key red light will flash and the left panel display screen will show [ENTER].

Enter a new five digit password using the number keys (1 through 0). An asterisk will show in the left panel display screen for each key press.

The left panel display screen will show [AGAIN].

Enter the new five digit password again.

The lock key red light will become solid.

Password Lockout Feature

This feature allows the owner to unlock the password feature so that a password does not need to be used every time the engine is started.

Turn the key switch to the RUN position to turn on the loaders electrical system.

Enter the five digit owner password using the number keys (1 through 0).

Figure 300



Press the unlock key (Item 2) [Figure 300].

The left panel display screen will show [CODE].

Enter the five digit owner password using the number keys (1 through 0). The unlock key green light will flash, then become solid.

The loader can now be started without using a password.

NOTE: Use the following procedure to reset the machine lock so that the loader requires a password to start the engine.

Turn the key switch to the RUN position to turn on the loaders electrical system.

Press the lock key (Item 1) [Figure 300].

The lock key red light will flash and the left panel display screen will show [CODE].

Enter the five digit owner password using the number keys (1 through 0). The unlock key green light will flash, then the lock key red light will become solid.

You must now enter the password every time to start the loader.



PASSWORD SETUP (DELUXE INSTRUMENTATION PANEL)

Password Setup is available on machines with a Deluxe Instrumentation Panel.

Password Description

All new machines with a Deluxe Instrumentation Panel arrive at Bobcat dealerships with the keypad in locked mode. This means that a password must be used to start the engine.

For security purposes, your dealer may change the password and also set it in the locked mode. Your dealer will provide you with the password.

Master Password:

A permanent, randomly selected password set at the factory which cannot be changed. This password is used for service by the Bobcat dealer if the owner password is not known; or to change the owner password.

Owner Password:

Allows for full use of the loader and to setup the Deluxe Instrumentation Panel. There is only one owner password. It must be used to change the owner or user passwords. Owner should change the password as soon as possible for security of the loader.

User Password:

Allows starting and operating the loader; cannot change password or any of the other setup features.

For the procedures to change passwords (See Changing The Owner Password on Page 196.) and (See Changing The User Passwords on Page 197.)

Changing The Owner Password

Figure 301

Press a scroll button (Item 1) repeatedly until the Security screen icon (Inset) is highlighted.

Enter owner password and press [ENTER].

Select [1. USER SETTINGS].

Select [1. OWNER].

Select [2. CHANGE PASSWORD].

Enter new owner password and press [ENTER].

You will be prompted to reenter the new owner password.

Press [ENTER].

P-90399/NA3025A/NA3016/NA3031/NA3033/NA3028/NA3015/NA3027

MAINTENANCE CLOCK

Description

The Maintenance Clock alerts the operator when the next service interval is due. *EXAMPLE:* The Maintenance Clock can be set to a 500 hour interval as a reminder for the next 500 hour planned maintenance.

Figure 304

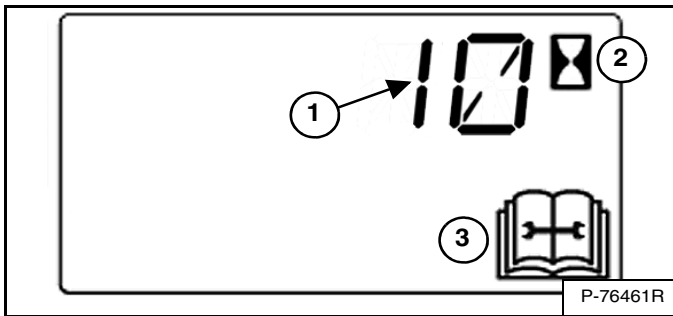

During machine operation, a two beep alarm will sound when there are less than 10 hours until the next planned maintenance.

The remaining hours before maintenance is required will appear in the data display (Item 1) for five seconds while the service icon (Item 3) and hourmeter icon (Item 2) [Figure 304] flash.

NOTE: The display will show negative numbers after counting down to zero.

The display will then revert back to the previous display and will appear for five seconds every time the machine is started until the maintenance clock is reset.

Figure 305



The Deluxe Instrumentation Panel, if equipped, will display a message (Item 1) [Figure 305] alerting the operator to service the machine.

This message will remain for 10 seconds and will appear for 10 seconds every time the machine is started until the maintenance clock is reset.

Figure 306



The Deluxe Instrumentation Panel, if equipped, will display a bar (Item 1) [Figure 306] showing time remaining until next service. This bar will turn red when service is past due. NEXT MAINTENANCE DUE will change to MAINTENANCE PAST DUE and display the number of hours past due.

Keys [4] and [9] can be used to adjust the service interval when the owner is logged in [Figure 306].

NOTE: Loaders equipped with a Standard Key Panel or Keyless Start Panel will not display the BobCARE PMSM message or NEXT MAINTENANCE TYPE on the right panel.

Setup

See your Bobcat dealer about installation of this feature.

Reset

See your Bobcat dealer to reset the maintenance clock.



SPECIFICATIONS

(S650) LOADER SPECIFICATIONS	201
Machine Dimensions	201
Performance	202
Engine	202
Drive System	203
Controls	203
Hydraulic System	204
Electrical System	205
Capacities	205
Tyres	206
Fuel Consumption	206
Environmental	206
Temperature Range	206



Bobcat®

(S650) LOADER SPECIFICATIONS

Machine Dimensions

- Dimensions are given for loader equipped with standard tyres and 74 in. Construction & Industrial bucket and may vary with other bucket types. All dimensions are shown in millimeters. Respective imperial dimensions are given in inches enclosed by parentheses.
- Where applicable, specifications conform to SAE or ISO standards and are subject to change without notice.

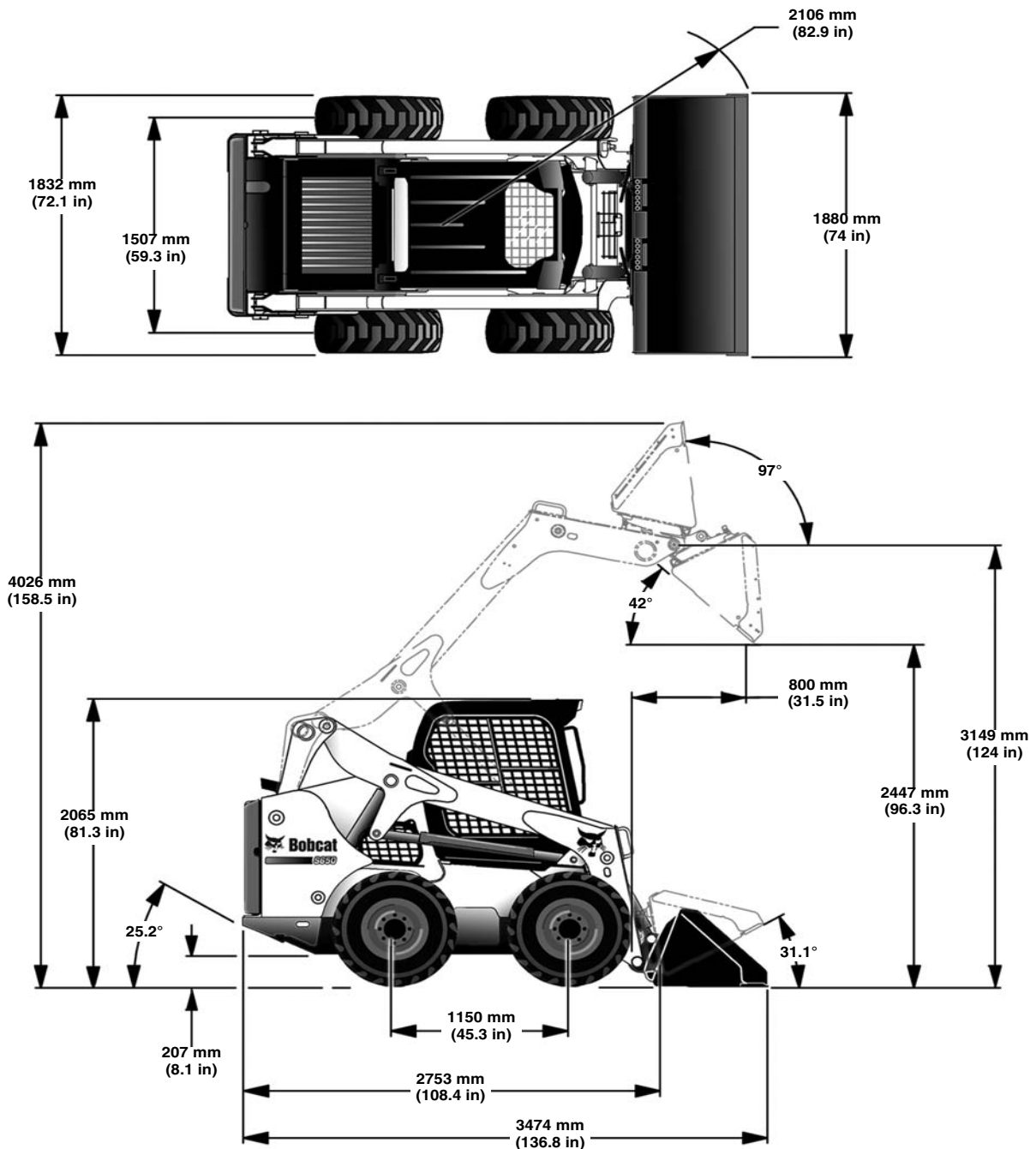

NA1660

Changes of structure or weight distribution of the loader can cause changes in control and steering response and can cause failure of the loader parts.



(S650) LOADER SPECIFICATIONS (CONT'D)

Performance

Rated Operating Capacity	1220 kg (2690 lb)
with 200 Pound Frame Mounted Counterweight Kit	1288 kg (2840 lb)
with 300 Pound Frame Mounted Counterweight Kit	1311 kg (2890 lb)
Tipping Load	2440 kg (5380 lb)
Operating Weight	3777 kg (8327 lb)
Breakout Force - Lift	2177 kg (4800 lb)
Breakout Force - Tilt	2313 kg (5100 lb)
Push Force	2087 kg (4600 lb)
Travel Speed	
- Single Speed Loader	0 - 11,4 km/h (0 - 7.1 mph)
- Two-Speed Loader (Opt.) Low/High	0 - 11,4 km/h (0 - 7.1 mph) / 0 - 19,8 km/h (0 - 12.3 mph)

Engine

Make / Model	Kubota / V3307-DI-TE3 Interim Tier IV
Fuel / Cooling	Diesel / Liquid
Horsepower	
- ISO 9249 EEC / SAE J1349 Net	52,4 kW (70.3 hp) @ 2400 rpm
- ISO 14396 Gross	54,6 kW (73.2 hp) @ 2400 rpm
- SAE J1995 Gross	55,4 kW (74.3 hp) @ 2400 rpm
Torque	
- ISO 9249 EEC / SAE J1349 Net	253,1 N•m (186.7 ft-lb) @ 1600 rpm
- SAE J1995 Gross	264,4 N•m (195.0 ft-lb) @ 1600 rpm
Low Idle rpm	1250 - 1450
High Idle rpm	2525 - 2650
Number of Cylinders	4
Displacement	3,3 L (203 in ³)
Bore / Stroke	94 mm / 120 mm (3.70 in / 4.72 in)
Lubrication	Gear Pump Pressure System with Filter
Crankcase Ventilation	Closed Breathing
Air Cleaner	Dry replaceable paper cartridge with separate safety element
Ignition	Diesel - Compression
Air Induction	Turbo-Charged
Engine Coolant	Propylene Glycol / Water Mixture
Starting Aid	Glow Plugs - Automatically activated as needed in RUN position.



(S650) LOADER SPECIFICATIONS (CONT'D)

Drive System

Main Drive	Fully hydrostatic, 4-wheel drive
Transmission	Infinitely variable tandem hydrostatic piston pumps, driving two fully reversing hydrostatic motors
Final Drive	Pre-stressed #120 HSOC endless roller chain (no master link) and sprockets in sealed chaincase with oil lubrication (Chains do not require periodic adjustments) Two chains per side with no idler sprocket
Axle Size	68,6 mm (2.70 in), Heat treated
Wheel Bolts	Eight - 9/16 in. Wheel bolts fixed to axle hubs

Controls

Vehicle Steering	Direction and speed controlled by two hand operated steering levers <i>or</i> optional joystick(s)
Loader Hydraulics - Lift and Tilt - Front Auxiliary - Rear Auxiliary (Option)	Controlled by separate foot pedals <i>or</i> optional Advanced Control System (ACS) <i>or</i> optional Advanced Hand Controls (AHC) <i>or</i> optional Selectable Joystick Controls (SJC) Controlled by electrical switch on Right Hand steering lever <i>or</i> joystick Controlled by electrical switch on Left Hand steering lever <i>or</i> joystick
Auxiliary Pressure Release	Pressure relieved through quick couplers; Push couplers in, hold for 5 seconds
Engine	Hand lever speed control, additional foot operated speed control pedal with SJC option; key-type start switch <i>or</i> optional Keyless Start Panel <i>or</i> optional Deluxe Instrumentation Panel and function error shutdown.
Starting Aid	Glow plugs automatically activated as needed by Instrument Panel
Service Brake	Two independent hydrostatic systems controlled by two hand operated steering levers <i>or</i> optional joystick(s)
Secondary Brake	One of the hydrostatic transmissions
Parking Brake (Standard)	Mechanical disc, manually operated switch on left instrument panel
Parking Brake (Two-Speed Option)	Spring applied pressure release multi-disk brake activated by manually operated switch on left instrument panel



(S650) LOADER SPECIFICATIONS (CONT'D)

Hydraulic System

Pump Type	Engine driven, gear type
Pump Capacity - Standard	87,1 L/min (23.0 U.S. gpm)
Pump Capacity - High-Flow Option	115,5 L/min (30.5 U.S. gpm)
System Relief at Quick Couplers	23,8 - 24,5 MPa (238 - 245 bar) (3450 - 3550 psi)
Filter (Hydraulic / Hydrostatic)	Replaceable beta 10 micron = 200, drop in element
Filter (Charge)	Replaceable beta 10 micron = 200, drop in element
Hydraulic Cylinders	Double-acting; tilt cylinders have cushioning feature on dump and rollback
Bore Diameter: Lift Cylinder (2)	76,2 mm (3.00 in)
Tilt Cylinder (2)	76,2 mm (3.00 in)
Rod Diameter: Lift Cylinder (2)	44,5 mm (1.75 in)
Tilt Cylinder (2)	41,4 mm (1.63 in)
Stroke: Lift Cylinder (2)	633,2 mm (24.93 in)
Tilt Cylinder (2)	354,8 mm (13.97 in)
Control Valve - Standard	3-Spool, open centre, manually operated with spring detent for lift float and electrically controlled auxiliary spool
Control Valve - ACS, AHC and SJC	3-Spool, open centre with electric actuator controlled lift with float and tilt. Electrically controlled auxiliary spool
Fluid Lines	SAE Standard tubelines, hoses and fittings
Hydraulic Function Time:	
Raise Lift Arms	3.9 Seconds
Lower Lift Arms	2.6 Seconds
Bucket Dump	2.3 Seconds
Bucket Rollback	1.7 Seconds



(S650) LOADER SPECIFICATIONS (CONT'D)

Electrical System

Alternator	Belt driven, 90 amperes, open frame
Battery	12 volts, 950 cold cranking amperes @ -18°C (0°F), 180 Minute reserve capacity @ 25 amperes
Starter	12 volts, gear type, 3,0 kW (4.02 hp)
Instrumentation	<p style="text-align: center;">Gauges: Engine Coolant Temperature, Fuel Level.</p> <p style="text-align: center;">Warning lights: Fuel Level, Seat Belt, Engine Coolant Temperature, Engine Malfunction, Hydraulic System Malfunction, General Warning.</p> <p style="text-align: center;">Indicators: BICS™ Functions, Two-Speed, 3-Point Shoulder Belt, Turn Signals, Engine Preheat.</p> <p style="text-align: center;">Data Display: Operating Hours, Engine rpm, Speed Management Setting, Maintenance Clock Countdown, Battery Voltage, Service Codes, Engine Preheat Countdown, Steering Drift Compensation Setting, Drive Response Setting.</p> <p style="text-align: center;">Other: Audible Alarm, Lights, Option / Accessory Switches.</p> <p style="text-align: center;">Optional Deluxe Instrumentation Panel: *Additional displays for: Engine rpm, Coolant Temperature and Oil Pressure; System Voltage, Hydrostatic Charge Pressure and Hydraulic Oil Temperature. *Additional Features Included: Keyless Start, Digital Clock, Job Clock, Password Lockout, Multi-language Display, Help Screens, Diagnostic Capability and Engine / Hydraulic Systems Shutdown Function.</p>

Capacities

Fuel	103,1 L (27.2 U.S. gal)
Engine Oil with Filter Change	11,4 L (12.0 qt)
Engine Cooling System with Heater	11,7 L (3.1 U.S. gal)
without Heater	11,4 L (3.0 U.S. gal)
Hydraulic / Hydrostatic Reservoir	10,2 L (2.7 U.S. gal)
Hydraulic / Hydrostatic System	45,0 L (11.9 U.S. gal)
Chaincase Reservoir	39,2 L (10.35 U.S. gal)



(S650) LOADER SPECIFICATIONS (CONT'D)

Tyres

Heavy Duty (Standard)	12.00 - 16.5, 12 Ply Rating
Heavy Duty Offset (Option)	12.00 - 16.5, 12 Ply Rating
Heavy Duty Poly Fill (Option)	12.00 - 16.5, 12 Ply Rating
Severe Duty (Option)	12.00 - 16.5, 12 Ply Rating
Severe Duty Poly Fill (Option)	12.00 - 16.5, 12 Ply Rating
Solidflex (Option)	33 x 6 x 11
Super Float Offset (Option)	33 x 15.50 - 16.5, 12 Ply Rating
Recommended Pressure	Inflate tyres to MAXIMUM pressure shown on the side wall of the tyre. DO NOT mix brands of tyres used on the same loader.

Fuel Consumption

Engine Load	Full - 100%	High - 70%	Medium - 50%	Low - 30%
Fuel Consumption Rate Per Hour	17,0 L (4.5 U.S. gal)	13,2 L (3.5 U.S. gal)	11,4 L (3.0 U.S. gal)	9,5 L (2.5 U.S. gal)
NOTE: The engine fuel consumption chart is to be used as a guideline only. The actual results may vary.				

Environmental

	Noise / Vibration Levels	Uncertainties (If Applicable)
Noise level LpA (EU Directive 2000/14/EC)	101 dB(A)	- - -
Operator position noise level (ISO 6396)	82,3 dB(A)	+2,5 / -0 dB(A)
Whole body vibration (ISO 2631-1) (limit 0,5 m/s ²)	0,76 m/s ²	0,38 m/s ²
Hand-arm vibration (ISO 5349-1) (limit 2,5 m/s ²)	1,54 m/s ²	- - -

Temperature Range

Operation and storage	-26 - +43°C (-15 - +110°F)
-----------------------	----------------------------



WARRANTY

WARRANTY 209



Bobcat®

WARRANTY

WARRANTY

BOBCAT LOADERS

DOOSAN BENELUX S.A. warrants to its authorised dealers who in turn warrant to the end-user / owner that each new Bobcat loader will be free from proven defects in material and workmanship for twelve months from the date of delivery to the end-user / owner or 2000 hours of machine usage, whichever occurs first.

During the warranty period, the authorised selling Bobcat dealer shall repair or replace, at DOOSAN BENELUX S.A.'s option, without charge for parts, labour and travel time of mechanics, any part of the Bobcat product which fails because of defects in material and workmanship. The end-user / owner shall provide the authorised Bobcat dealer with prompt written notice of the defect and allow reasonable time for replacement or repair. DOOSAN BENELUX S.A. may, at its option, request failed parts to be returned to the factory. Transportation of the Bobcat product to the authorised Bobcat dealer for warranty work is the responsibility of the end-user / owner.

Service schedules must be adhered to, documented and genuine parts / lubricants must be used. The warranty does not cover oils and lubricants, coolant fluids, filter elements, tune-up parts, bulbs, fuses, ignition system parts (glow plugs, fuel injection pumps, injectors), alternator fan belts, drive belts and other high-wear items. Pins and bushings are considered to be normal consumable items and are not warranted.

The warranty does not apply to tyres or other trade accessories not manufactured by Bobcat. The owner shall rely solely on the warranty, if any, of the respective manufacturers thereof. The warranty does not cover damages resulting from abuse, accidents, alterations, use of the Bobcat product with any bucket or attachment not approved by Bobcat, air flow obstructions, or failure to maintain or use the Bobcat product according to the instructions applicable to it.

DOOSAN BENELUX S.A. EXCLUDES OTHER CONDITIONS, WARRANTIES OR REPRESENTATIONS OF ALL KINDS, EXPRESSED OR IMPLIED, STATUTORY OR OTHERWISE (EXCEPT THAT OF TITLE) INCLUDING ALL IMPLIED WARRANTIES AND CONDITIONS RELATING TO MERCHANTABILITY, SATISFACTORY QUALITY AND FITNESS FOR A PARTICULAR PURPOSE.

CORRECTIONS BY DOOSAN BENELUX S.A. OF NONCONFORMITIES WHETHER PATENT OR LATENT, IN THE MANNER AND FOR THE TIME PERIOD PROVIDED ABOVE, SHALL CONSTITUTE FULFILMENT OF ALL LIABILITIES OF DOOSAN BENELUX S.A. FOR SUCH NONCONFORMITIES, WHETHER BASED ON CONTRACT, WARRANTY, TORT, NEGLIGENCE, INDEMNITY, STRICT LIABILITY OR OTHERWISE WITH RESPECT TO OR ARISING OUT OF SUCH PRODUCT.

THE REMEDIES OF THE END-USER / OWNER SET FORTH UNDER THE PROVISIONS OF THE WARRANTY OUTLINED ABOVE ARE EXCLUSIVE AND THE TOTAL LIABILITY OF DOOSAN BENELUX S.A. INCLUDING ANY HOLDING, SUBSIDIARY, ASSOCIATED OR AFFILIATED COMPANY OR DISTRIBUTOR WITH RESPECT TO THIS SALE OR THE PRODUCT AND SERVICE FURNISHED HEREUNDER IN CONNECTION WITH THE PERFORMANCE OR BREACH THEREOF, OR FROM DELIVERY, INSTALLATION, REPAIR OR TECHNICAL DIRECTION COVERED BY OR FURNISHED UNDER THIS SALE, WHETHER BASED ON CONTRACT, WARRANTY, TORT, NEGLIGENCE, INDEMNITY, STRICT LIABILITY OR OTHERWISE SHALL NOT EXCEED THE PURCHASE PRICE OF THE PRODUCT UPON WHICH SUCH LIABILITY IS BASED.

DOOSAN BENELUX S.A. INCLUDING ANY HOLDING, SUBSIDIARY, ASSOCIATED OR AFFILIATED COMPANY AND DISTRIBUTOR SHALL IN NO EVENT BE LIABLE TO THE END-USER / OWNER, ANY SUCCESSORS IN INTEREST OR ANY BENEFICIARY OR ASSIGNEE RELATING TO THIS SALE FOR ANY CONSEQUENTIAL, INCIDENTAL, INDIRECT, SPECIAL OR PUNITIVE DAMAGES ARISING OUT OF THIS SALE OR BY ANY BREACH THEREOF, OR ANY DEFECT IN, OR FAILURE OF, OR MALFUNCTION OF THE PRODUCT UNDER THIS SALE, WHETHER BASED UPON LOSS OF USE, LOST PROFITS OR REVENUE, INTEREST, LOST GOODWILL, WORK STOPPAGE, IMPAIRMENT OF OTHER GOODS, LOSS BY REASON OF SHUTDOWN OR NON-OPERATION, INCREASED EXPENSES OF OPERATION OR CLAIMS OF USER OR CUSTOMERS OF THE USER FOR SERVICE INTERRUPTION WHETHER OR NOT SUCH LOSS OR DAMAGE IS BASED ON CONTRACT, WARRANTY, TORT, NEGLIGENCE, INDEMNITY, STRICT LIABILITY OR OTHERWISE.



Bobcat[®]

4700002-EN (1-10)

Printed in Belgium



Bobcat®



ALPHABETICAL INDEX

(S650) LOADER SPECIFICATIONS	201	LOADER STORAGE AND RETURN TO SERVICE	184
AIR CLEANER SERVICE	148	LUBRICANTS AND FLUIDS	10
AIR CONDITIONING BELT	175	LUBRICATING THE LOADER	178
ALTERNATOR BELT	173	MACHINE SIGNS (DECALS)	24
ATTACHMENT CONTROL DEVICE (ACD)	85	MAINTENANCE CLOCK	198
ATTACHMENTS	102	MAINTENANCE SAFETY	129
BACK-UP ALARM SYSTEM	139	MONITORING THE DISPLAY PANELS	99
BACK-UP ALARM SYSTEM	66	OPERATING PROCEDURE	110
BOBCAT COMPANY IS ISO 9001 CERTIFIED	9	OPERATOR CAB	141
BOBCAT INTERLOCK CONTROL SYSTEM (BICS™)	132	OPERATOR CAB	58
BOBCAT INTERLOCK CONTROL SYSTEM (BICS™)	61	OPERATOR SAFETY WARNINGS	1
BOB-TACH (HAND LEVER)	182	PARKING BRAKE	62
BOB-TACH (POWER)	183	PASSWORD SETUP (DELUXE INSTRUMENTATION PANEL)	196
CONTROL IDENTIFICATION	54	PASSWORD SETUP (KEYLESS START PANEL)	195
CONTROL PANEL SETUP	193	PIVOT PINS	181
COUNTERWEIGHTS	101	PRE-STARTING PROCEDURE	88
DAILY INSPECTION	86	PUBLICATIONS AND TRAINING RESOURCES	23
DECLARATION OF CONFORMITY	7	REAR DOOR (TAILGATE)	144
DELIVERY REPORT	11	REAR GRILLE	145
DIAGNOSTIC SERVICE CODES	187	REGULAR MAINTENANCE ITEMS	9
DRIVE BELT	176	SAFETY INSTRUCTIONS	19
DRIVE RESPONSE	73	SEAT BAR RESTRAINT SYSTEM	134
DRIVING AND STEERING THE LOADER	67	SEAT BAR RESTRAINT SYSTEM	60
ELECTRICAL SYSTEM	158	SEAT BELT	136
EMERGENCY EXIT	64	SERIAL NUMBER LOCATIONS	11
ENGINE COOLING SYSTEM	155	SERVICE SCHEDULE	131
ENGINE LUBRICATION SYSTEM	153	SPARK ARRESTER MUFFLER	170
ENGINE SPEED CONTROL	63	SPEED MANAGEMENT	71
FEATURES, ACCESSORIES AND ATTACHMENTS	13	STARTING THE ENGINE	92
FINAL DRIVE TRANSMISSION (CHAINCASE)	172	STEERING DRIFT COMPENSATION	75
FIRE PREVENTION	21	STOPPING THE ENGINE AND LEAVING THE LOADER	100
FUEL SYSTEM	150	STOPPING THE LOADER	69
HEATING, VENTILATION AND AIR CONDITIONING (HVAC)	146	TOWING THE LOADER	121
HYDRAULIC / HYDROSTATIC SYSTEM	164	TRACTION LOCK OVERRIDE	63
HYDRAULIC CONTROLS	77	TRANSPORTING THE LOADER ON A TRAILER	123
INSTRUMENT PANEL IDENTIFICATION	41	TWO-SPEED CONTROL	70
LIFT ARM BYPASS CONTROL	62	TYRE MAINTENANCE	171
LIFT ARM SUPPORT DEVICE	137	WARRANTY	209
LIFTING THE LOADER	121		
LOADER IDENTIFICATION	12		



Bobcat®



