



0 ▶▶ Introduction ◀◀

Thank you for the trust you have showed us buying a C.M.C. mobile elevating work platform (MEWP). We are sure you will be pleased with your choice.

0.1 ▶ Content of the manual ◀







This manual contains the technical specifications and the instructions for transfer, use and maintenance of the MEWP. While drawing up this manual, we took into consideration all the operations that are part of a normal use and a regular maintenance of the machine. So, for a correct and optimum use, you must follow the described instructions carefully.

This manual has been drawn up in order to:

- ❑ Show the technical features of the machine;
- ❑ Describe the control stations and their commands;
- ❑ Provide with the instructions for the transport, placement and use of the machine;
- ❑ Describe the safety devices;
- ❑ Point out the potential risks and/or possible dangerous situations;
- ❑ Provide with the necessary instructions for the ordinary maintenance operations;
- ❑ Provide with the instructions for the filling of the check register.

📖 THE USE AND MAINTENANCE MANUAL IS CONSIDERABLE AS A PART OF THE MACHINE. In case of sale of the MEWP, please give this manual to the new owner.

LEGEND OF THE SYMBOLS USED IN THIS MANUAL:

 (CAUTION)	= warns the user about the risk of serious damages to people or to part of the equipment or the machine, if you do not obey the safety regulations.
 (WARNING)	= notifies the possibility of minor injuries to people or little damages to the platform or machine parts.
 (FORBIDDEN)	= prohibition signal
 (OBLIGATION)	= obligation signal
 (CAUTION)	= warns the user about the risk of environmental pollution.
* (OPTIONAL)	= indicates an optional outfit.
 (IMPORTANT NOTE)	= indicates information and suggestions useful to work with the MEWP.

-  This manual is addressed to:
- **users:** operators, ground assistants, guard staff, safety manager, service manager;
 - **manufacturers, dealers, owners, lessors or lessee, brokers.**



0.2 ▶ Disclaimer ◀

C.M.C. declines all responsibility in case of partial or total non-observance of the following instructions

- ➔ Before proceeding with any operation of use of the machine, the user is obliged to read carefully the text of this manual, with reference to sections relative to specific work activity to perform.
- ➔ The use of the machine must be entrusted only to trained and authorized staff. This manual cannot replace in any way a suitable experience that the staff in charge must have gained previously on similar machines or that they will be able to get on this machine, under the guidance of an already trained staff.
- ➔ The user must work within the functional limits of the machine and perform a constant and diligent maintenance, using only original spare parts indicated by C.M.C.
- ➔ The operator shall carefully know the safety standards foreseen by national and international legislations and apply them during all operations with the MEWP.

☞ **The guarantee of proper functioning and full compliance of the machine with the intended service is strictly dependent on the correct application of all the instructions contained in this manual.**

☞ **The non-compliance with the previous items automatically invalidates the warranty.**

0.3 ▶ Where and how to keep the manual ◀

- ➔ **The manual must be stored and kept in the best possible condition (away from sunlight), in a suitable place, for the purpose of always being available for consultation.**
- ➔ **This manual (or its copy) must always be on the machine** (in a case near the turret) for an immediate consultation by the operator during working operations.

- ➔ **Another copy shall be held by the basket operator during the working period inside the internal documents case.**
- ➔ **In case of loss or deterioration, the replacement documentation must be requested to C.M.C. s.r.l, citing the code of this manual.**

0.4 ▶ Regulatory references ◀



This manual has been drawn up according to the following national and international laws and directives:

Directive 2006/42/CE	ISO 3864	EN 280:2015
Directive 93/68/CEE	ISO 4302	EN 349
ISO 12100	ISO 4305	EN 60068-2-64
ISO 13849-1-2	ISO 4309	EN 60204-1-32
ISO 13850-13854	ISO 20381	EN 60529
ISO 13857	EN 13001	EN 62061
ANSI/SAIA A92.20-2018	ANSI/SAIA A92.24-2018	ANSI 92.6-2006
ANSI/SAIA A92.22-2018	ANSI Z359.1	CSA 354.1-2006



0.5 ▶ Amendments and integrations ◀

The information and legislative references present in this manual are those in force when the machine has been placed on the market.

Due to the constant and continuous improvement of their product by the manufacturers, the supplied machine could present some technical specifications different from those described on this manual. Any change will be however accompanied with specific documents attached explaining functional characteristics. In case of differences in comparison with the basic contents of this manual, the user is kindly asked to contact C.M.C. to receive supplementary technical specifications.

As this manual includes both current and optional components, you could find information not applicable to your machine.

C.M.C. reserves the right to update its production and its instruction manuals (without prior notice) according to the development of the technique, to the acquisition of new experiences and/or the change of law provisions, without being anyway obliged to intervene on the previously sold machines and on their manuals.

No part of this publication can be translated, modified or reproduced (even partially) without the expressed authorization of C.M.C. s.r.l.

C.M.C. reserves the right to modify - totally or partially - any data or specification of this publication (without prior notice).

Data and references indicated in this manual are those in force at the time of printing.

Year 2019
C.M.C. s.r.l.



1 ►► Specifications ◀◀

1.1 ► Technical sheet ◀

PERFORMANCE		
Max. working height	18,70 m	61.35 ft
Max. work outreach (long area with 200/220 kg)	8,60 m	28.22 ft
Max. work outreach (long area with 80 kg)	11,50 m	37.73 ft
Max. load on the basket	220 kg (USA) 200 kg (CE)	485 lb (USA) 441 lb (CE)
Turret rotation	+/-355° (710° continuous)	
Basket rotation (*optional)	+90°/-87°	
(P) Max. slope to stabilize	26°/49%	
(W) Max. ramp slope (attack)	31°/60%	
(X) Max. slope to travel	17°/31%	
Travel speed	0,60 - 1,38 km/h	0.37 - 0,86 mph

DIMENSIONS		
(A) Basket height	1,10 m	3.61 ft
(B) Basket width	0,60/0,70 m	1.97/2.30 ft
(C) Basket length	0,80/1,20/1,40 m	2.62/3.94/4.59 ft
(D) Total length	4,85 m	15.91 ft
(F) Height in driving position	1,99 m	6.53 ft
(G) Total width (without basket)	0,90 m	2.95 ft
(H) Clearance from the ground in transport configuration	0,18 m	0.59 ft
(H') Max. height to stabilize	1,00 m	3.28 ft
(H'') Max. height to climb over an obstacle	0,50 m	1.64 ft
Tracks (l x h)	1,75 x 0,25 m	5.74 x 0.82 ft
Width tracks adjustment (*optional)	0,90/1,30 m	2.95/4.27 ft

(J) Max. longitudinal stabilization	4,14 m	13.58 ft
(K) Max. cross stabilization	3,54 m	11.61 ft
(N) Min. longitudinal stabilization	3,54 m	11.61 ft
(O) Min. cross stabilization	2,72 m	8.92 ft
Intermediate cross stabilization	3,12 m	10.24 ft
Outriggers plate Ø	0,18 m	0.59 ft

WEIGHT AND PRESSURES		
Total weight	2617 kg	5769 lb
(R) Max. pressure on the foot	6,6 Kg/cm ² (64,72 N/cm ²)	93.87 lb/in ²
(S) Max. pressure on the track	0,17 Kg/cm ² (1,67 N/cm ²)	2.42 lb/in ²
(T) Max. pressure in travel	400 Kg/m ² (3,92 KN/m ²)	81.93 lb/ft ²
(U) Max. pressure in work (4 feet opened)	228 Kg/m ² (2,24 KN/m ²)	46.70 lb/ft ²
(V) Max. pressure in work (4 feet closed)	242 Kg/m ² (2,38 KN/m ²)	49.57 lb/ft ²

POWERS	
Standard hydraulic feed	1) Honda GX390 petrol, 8.7 kW (11.7 HP), 3600 rpm
*Optional feeds	2) Yanmar L100V diesel, 6.8 kW (9.1 HP), 3600 rpm 3) Honda iGX390 petrol, 8.7 kW (11.7 HP), 3600 rpm 4) Kubota Z602-E4B diesel, 10.8 kW (14.5 HP), 3200 rpm 5) Electric engine 110/120/230 V 6) Motor G0901306, 9 kW, 48 V, with lithium batteries 160 Ah 7) Hybrid version
Fuel tank capacity	6,1/15 l



Max allowed speeds according to USA/EU standards	
Max allowed lifting and descending speed of the MEWP	0,4 m/s (1.31 ft/s)
Max allowed boom extension and withdrawal speed	0,4 m/s (1.31 ft/s)
Max allowed rotation speed	0,7 m/s (2.3 ft/s)
Max allowed manual force in the basket with 1 operator	400 N

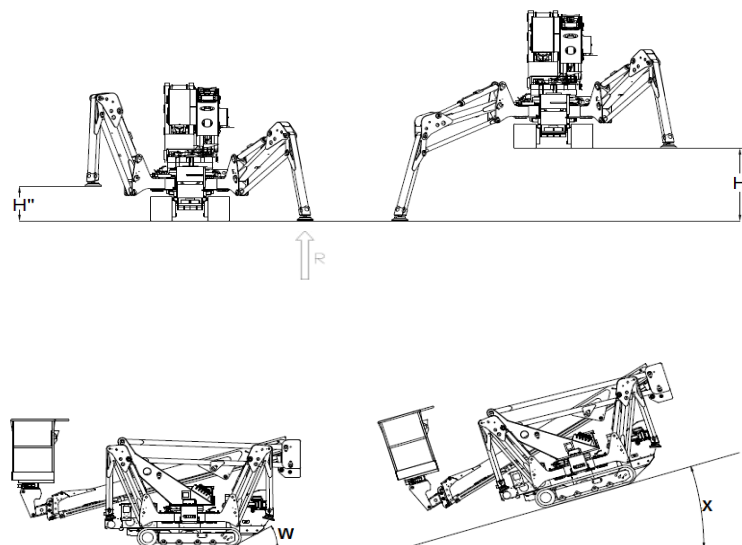
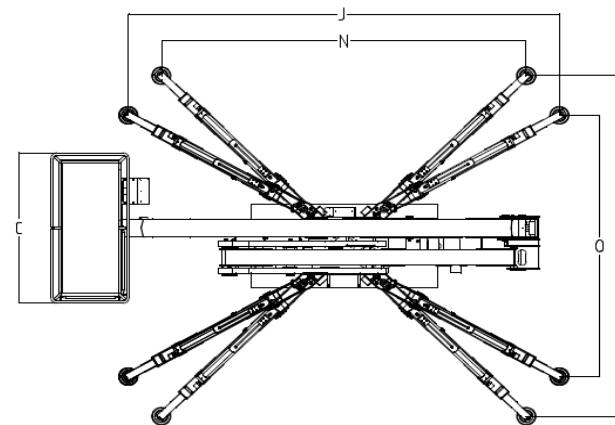
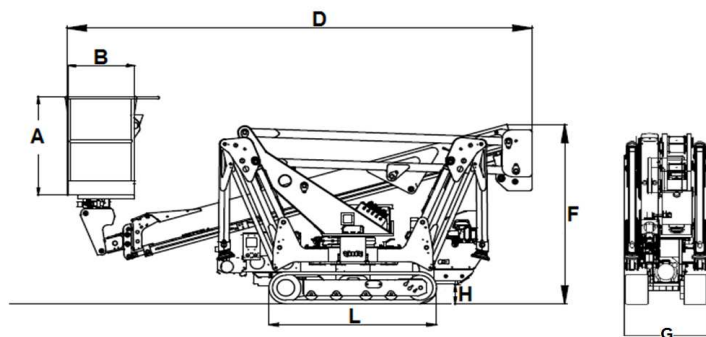

		Tightening torque
Bolts of the bearing	M16 cl 10.9	28 daNm

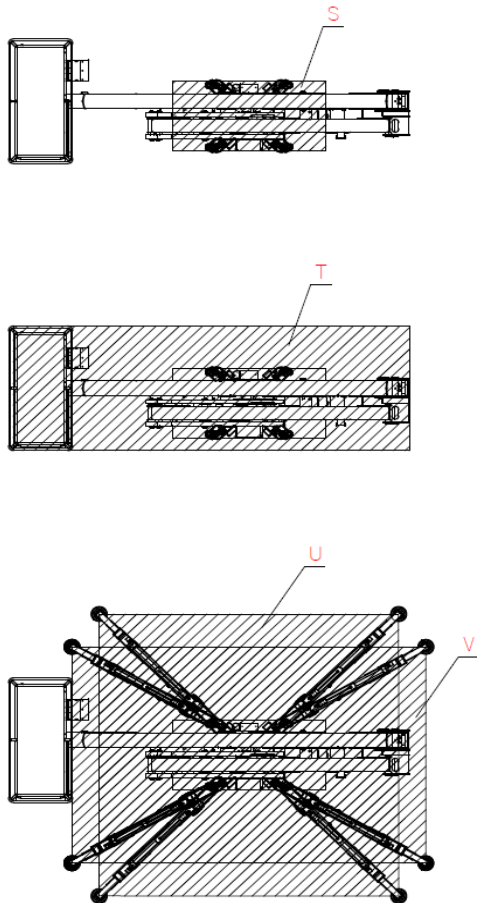



1.2 Identification plate

On the MEWP turret, there is a plate with all the identification data of the machine:

		C.M.C. s.r.l. Via Bitritto, 119 70124 BARI - ITALY Tel. 080 5326606/557 http://www.cmclift.com E-mail: info@cmclift.com			
TYPE	S19	MANUFACTURER	C.M.C.		
MODEL	S19HD (PRO)	YEAR	2020		
SERIAL NR.	S19A2140	TOT. WEIGHT	6173 lbs		
CAPACITY	441 lbs	INCLUDING	2 persons		
MAX HYDRAULIC OPERATING PRESSURE		3336 PSI			
MAX MANUAL HORIZONTAL FORCE ALLOWED		90 lbs			
MAX WIND SPEED ALLOWED		28 mph			
MAX FRAME INCLINATION ALLOWED		1°			
EXTERNAL POWER SOURCE	230 V	50 Hz			

Picture 1: identification plate.



1.3 ▶ CE certification ◀

C.M.C. s.r.l. states under its own responsibility that **S19HD PRO** was designed and produced in compliance with national and European standards, and that the machine is identical to the model submitted to control and test for the “CE certification” by the Notified Institute **nr. 1878 - VERICERT s.r.l. - via L. Masotti, 5 – 48124 Ravenna – Italy.**

1.4 ▶ TÜV certification ◀

C.M.C. s.r.l. states under its own responsibility that **S19HD PRO** was designed and produced in compliance with US standards ANSI/SAIA A92.20:2018 and that the machine is identical to the model submitted to control and test for the “TÜV certification” by **TÜV SÜD America Inc.** TÜV SUD America Inc. is an OSHA recognized NRTL and a Standards Council of Canada accredited certification body.

1.5 ▶ Classification ◀

The mobile elevating work platform (MEWP) S19HD PRO belongs to group B: the vertical projection of the center of the area of the MEWP in different platform configurations specified by the manufacturer can be outside the tipping lines (EN 280 par. 1.4 - ANSI/SAIA A92.20 par. 3).

As for the displacement, it belongs to type 1: travelling is only allowed with the MEWP in its transport configuration or in the stowed position (EN 280 par. 1.4 - ANSI/SAIA A92.20 par. 3).

1.6 ▶ Loading cycles ◀

The machine is expected to live for 40.000 working cycles¹ (i.e. 10 years, 40 weeks per year, 20 hours per week, 5 cycles per hour).

Within this term, the machine must undergo at least 2 (two) in-depth checks (structural, mechanical, electric, elements, etc.), **in case of heavy uses** (frequent use at the performance limit, unfavourable environmental conditions such as steel systems, paper mills and so on) **it is better to increase the checks.** Anyway, **it is advisable to have the state of the machine checked by the manufacturer factory or by an authorized assistance point, at least every 1500 – 2000 working hours or once a year.**

¹Loading cycle: cycle starts from the access position, continues performing the work and finishes returning to the access position.

1.7 ▶ Working diagram and stabilization areas ◀

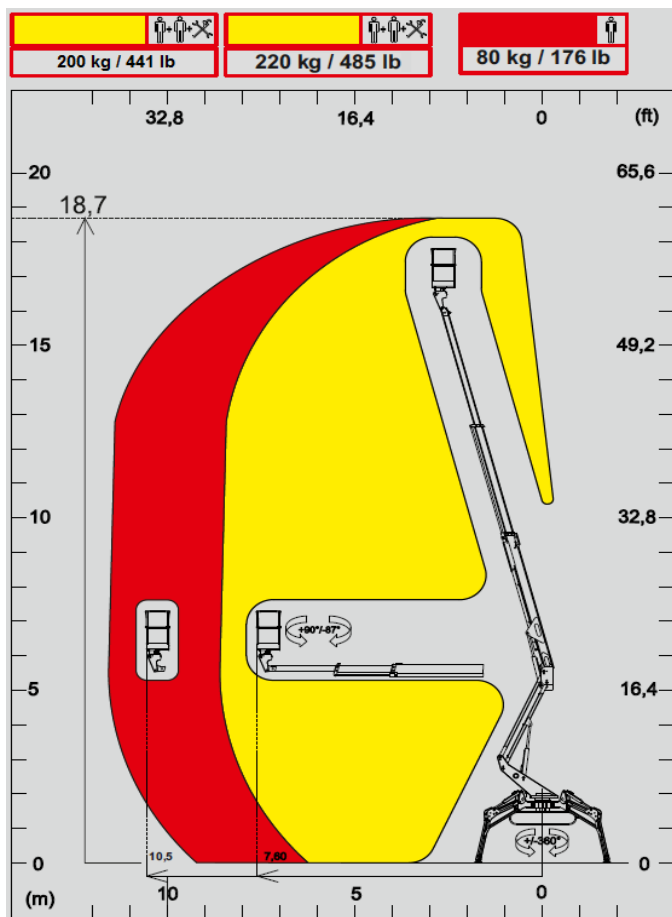

Picture 2a: working diagram.

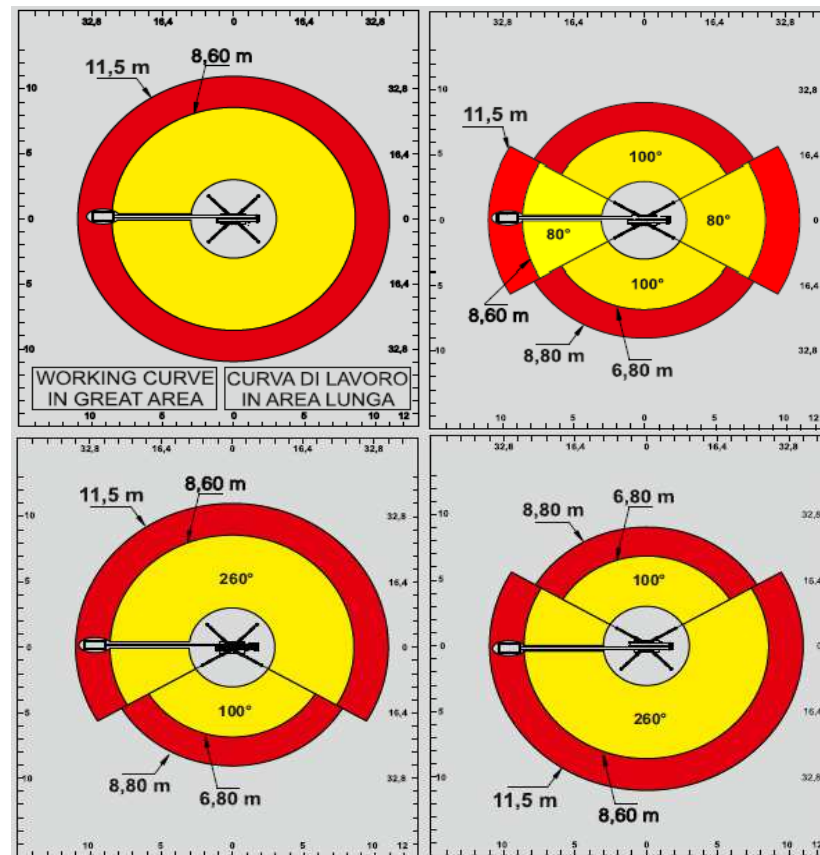

Picture 2b: stabilization areas.

2 ▶▶ Description and purpose ◀◀

2.1 ▶ Definition ◀

The machine is called **S19HD PRO** and it is a mobile elevating work platform (MEWP):

- machine/device intended for moving persons, tools and material to working positions, consisting of at least a work platform with controls, an extending structure and a chassis (ANSI/SAIA 92.20 par. 3);
- mobile machine intended to move persons to working positions, where they are carrying out work from the work platform, with the intention that persons are getting on and off the MEWP only at access positions at ground level or on the chassis and which consists as a minimum of a work platform with controls, an extending structure and a chassis (EN 280 par. 3.1).



It is forbidden to access to or exit from the work platform at different levels.

2.2 ▶ Machine purpose ◀

The MEWP **S19HD PRO** is a machine which enables the operators to reach the working place when this is high-positioned.

The machine has been designed for an essentially vertical use. It must be transported only when it is totally folded in the transport position.



The use of the machine is allowed only to professional staff, properly trained and specialized.

2.3 ▶ Description of the main components ◀

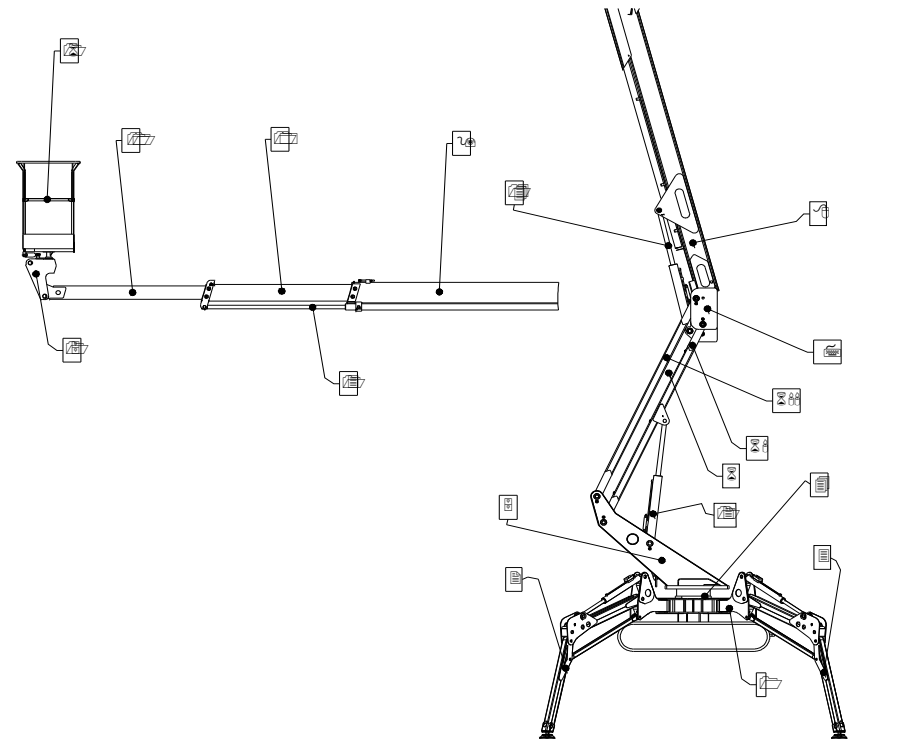

Picture 3: main components of the MEWP.



2.3.1 ▶ Frame

The frame **1** (Picture 3) is a steel structure having a quality appropriate in order to distribute the weight of the equipment when the MEWP is in driving position. The frame is equipped with 4 hydraulic jacks used for stabilisation [2 front stabilizers cylinders **2** (Picture 3), 2 rear stabilizers cylinders **3** (Picture 3). The base **4** (Picture 3) for the support slewing ring is on the frame and through the rotation unit allows the tilting of the equipment.

2.3.2 ▶ Turret

The turret **5** (Picture 3), made of quality steel, is fixed to the bearing (slewing ring). The rotation of the superstructure is allowed by a hydraulic motor with brake normally closed, constrained to the turret.

2.3.3 ▶ Pantograph

The pantograph **6** (Picture 3) is constituted by two parallel arms (pantograph upper crank **6'** (Picture 3) and pantograph lower crank **6''** (Picture 3) and by the pantograph connecting rod **7** (Picture 3). The arms (tubular with rectangular section, bended and electro-welded) and the connecting rod are made with high quality steel sheets. The movement of the pantograph (lifting and lowering the pantograph) is obtained thanks to the hydraulic cylinder for lifting the pantograph **12** (Picture 3). This cylinder is fastened to the turret (barrel side) and to the upper pantograph crank (rod side) and is equipped with double-acting balancing valve. The pantograph has a working range from 0° to about +65° with respect to the horizontal.

2.3.4 ▶ Telescopic boom

The telescopic boom **8** (Picture 3) is hinged to the turret. The telescopic boom is composed of three elements: a fixed boom **9** (Picture 3) hinged to the turret and two telescopic booms **10** **11** (Picture 3). The extraction movement (or return) of the telescopic boom is obtained by moving the "telescopic boom extraction cylinder" **13** (Picture 3).

The lifting (or lowering) movement of the telescopic boom is obtained by moving the "telescopic boom lifting cylinder" **14** (Picture 3).

2.3.5 ▶ Basket

The basket **16** (Picture 3) is connected to the second boom of the telescopic element through the oscillating support **15** (Picture 3). It is made with tubular aluminium or steel, bent, welded and hot galvanised, covered in fibreglass* or made in a structure completely in fibreglass*; it is equipped with side or front opening for operator access. The opening is self-hinged and built to avoid accidental openings. The platform is provided with attachments for the safety belts, a guard-rail at a height of 1.1 m from the floor, an intermediate guard-rail and a foot guard band along all the sides of the platform. The floor is in anti-skid and self-draining aluminium.

3 ▶▶ Control positions ◀◀

3.1 ▶ Engines ignition station ◀

The machine engine ignition station is generally positioned on the chassis (Picture 4a).

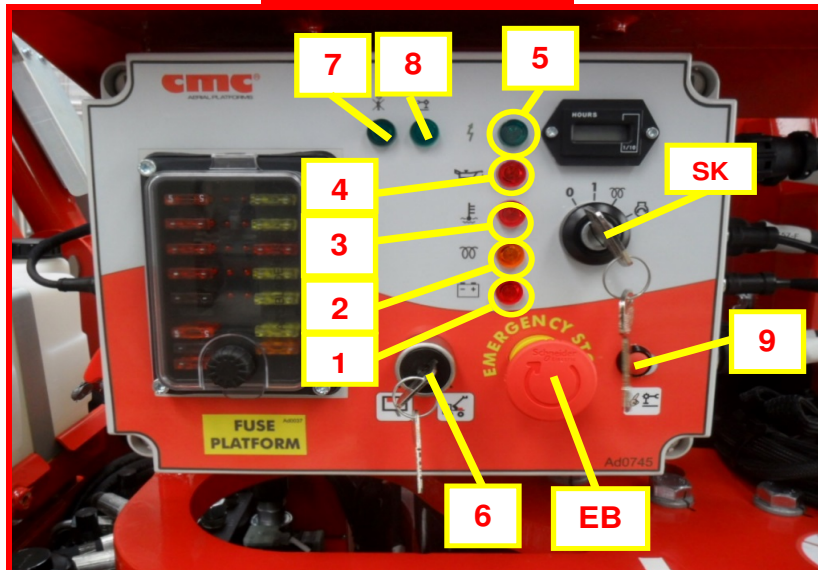

Picture 4a: engine ignition station.

It consists of an electrical panel in which there are:

- **the SK key:** through it, it is possible to turn on the electric system and start the endothermic engine;
- **the hour counter;**
- **the green light 5 indicating system power supply:** it is on when the SK key is in position 1;
- **the red light 4 which signals low pressure to the engine oil;**
- **the red light 3 which monitors coolant level;**
- **the orange light 2 indicating the spark plugs working;**
- **the red light 1 which signals an alternator failure;**
- **the control station selector 6:** at left it enables the basket control station, at right the radio control on the ground
- **the platform consent light 7:** if lighted on, it allows the maneuvers of the aerial part only with stabilization correctly performed.
- **the stabilization consent light 8:** if lighted on, it allows the movement of the outriggers only with the boom and the pantograph rested on their supports.
- **the fuse box;**
- **the emergency red mushroom-shaped button EB** that blocks the machine, removing the power supply to the control circuits. This button has priority over all other commands; thus, it allows only manual descent to the ground.



The emergency button has a mechanical locking device; therefore, it must be unlocked by turning it clockwise to reactivate the normal machine working.

- **the “dead man” stabilizers button 9:** it must be held pressed together with other levers of outriggers control station to stabilize or destabilize.

If the machine is equipped with a petrol engine or in a hybrid version (petrol + electric engine), the control station includes an ignition key lock positioned directly on the motor group (Picture 4a): turning to the right the **SK key**, it is possible to switch on the electric system and start the endothermic engine.

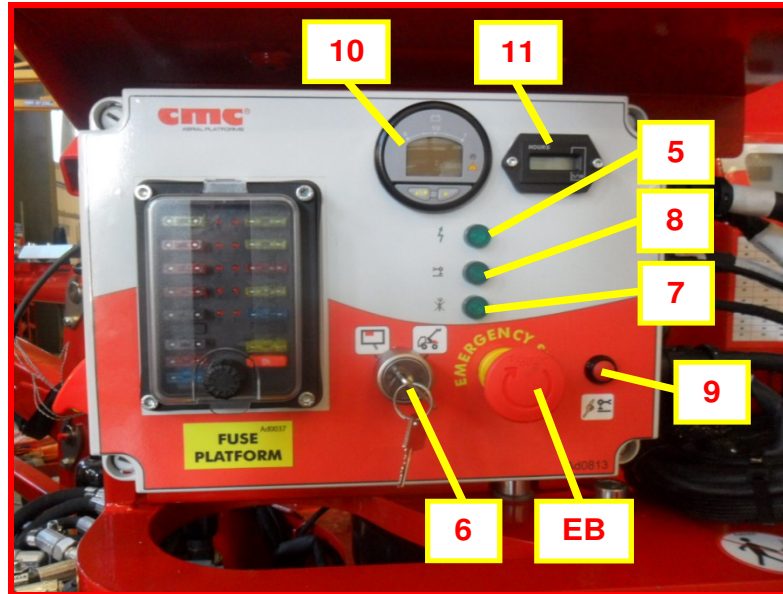

Picture 4b: ignition station in case of hybrid or full lithium version.

In hybrid version and in a full lithium equipment, the electrical box mounted on the chassis (Picture 4b) changes as below:

- **the green light 5 indicating machine power supply:** it is on when the SK key is in position I;
- **the control station selector 6:** at left it enables the basket control station, at right the radio control on the ground.
- **the platform consent light 7:** if lighted on, it allows the maneuvers of the aerial part only with stabilization correctly performed.
- **the stabilization consent light 8:** if lighted on, it allows the movement of the outriggers only with the boom and the pantograph rested on their supports.
- **the emergency red mushroom-shaped button EB** that blocks the machine, removing the power supply to the control circuits. This button has priority over all other commands; thus, it allows only manual descent to the ground.



The emergency button has a mechanical locking device; therefore, it must be unlocked by turning it clockwise to reactivate the normal machine working.

- the “**dead man**” **stabilizers button 9**: it must be held pressed together with other levers of outriggers control station to stabilize or destabilize.
- **the fuse box;**
- **the battery charge indicator 10;**
- **the hour counter 11.**



Before performing any operation, it is necessary to place the ignition key in position 1.



Picture 5: left side of chassis box.



In all engine equipment, on the left side of this case (Picture 5), you can find:



- **the red sealed key 2** to bypass engine anomalies that block the platform manoeuvres;
- **the yellow sealed key 3** to bypass the emergency stop in the basket, only in case of danger;
- **the red sealed key 4** to enable the emergency electropump;
- **the remote connection on/off lever and the connector** to receive technical assistance from C.M.C. Service or authorized workshops;
- **the 12 V socket;**
- **the buzzer.**

3.1.1 ▶ Ignition of the endothermic engine

In order to start the endothermic engine, turn the SK key all the way to the right up to the symbol .

Before starting the engine, especially if the MEWP is used in workplaces with low atmospheric temperatures, it is advisable to heat the spark plugs of the machine engine while keeping the key on the symbol  for a few seconds: this will cause the corresponding orange light  (Picture 4a) to turn on.

The ignition of the endothermic engine can also be carried out with the radio/wired control. Using it on the ground or in the basket:

- turn the **SK** key to position 1;
- move the lever in the Picture 5 upwards, present on the left side of the radio/wired control under the joystick **J1** (Picture 8);
- in this case, the green light  (Picture 4a) will light up on the switching on/off station to signal the correct power supply of the machine.

To switch off the endothermic engine, you can alternatively:

- turn the **SK** key all the way to the left on position 0;
- lift the lever  in the Picture 8;
- press, in emergency situations, one of the emergency buttons on the machine (par. 4.5.1).

3.1.2 ▶ Switching on/off the electric engine (*optional)

On the machine, it can also be provided an auxiliary electric engine (*optional).

If you choose to use it:

- connect the 110/120/230 V socket to the nearest electrical source;

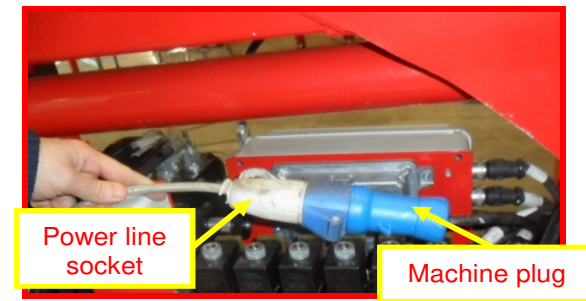

Picture 6: power line socket.

- from the radio/wired control, start the engine by pushing the lever in Picture 5 downwards;
- the power supply is signaled by the lighting up of the green led  (Picture 4a) on the switching on/off station.

To switch off the electric* engine, it will be enough to alternatively:

- turn the **SK** key all the way to the left on position 0;
- lower the lever mentioned above;
- press, in emergency situations, one of the emergency buttons provided on the machine (par. 4.5.1).



It is not possible to turn on both the endothermic engine and the electric engine at the same time.

3.1.3 ▶ Other power supplies *optional

The machine can be supplied on request completely with a 48 V electric engine powered by 160 Ah lithium batteries or with a hybrid feed.



It is not possible to have the 48 V electric engine and the 110/120/230 V engine fitted on the machine at the same time.

The start and stop of the 48 V electric engine will be the same shown above for 110/120/230 V electric engine.

To recharge the batteries:

1. couple the 110/120/230 V socket (power line) to the plug on the machine and move upward the button provided on the machine's thermal magnetic panel;
2. from this moment the batteries will be charging and, if the electric system is ON, the progress of the charging process will be shown on the control station LED panel (Picture 9).



When the state of batteries charge, during the use, reaches the lowest level (under 10%), all work maneuvers will be interrupted, and it will only be possible to close the machine again.



It is absolutely forbidden to direct high-pressure jets of water onto the support containing the battery pack. High water pressure could generate serious and irreversible problems in the operation of the machine.

3.2 ▶ Platform control stations ◀

There are the following platform control stations:

1. the first one (operating) is the AUTEK radio control station (Picture 8);
2. the second one (operating) is the AUTEK wired remote control station in the basket;
3. the third one (emergency) is totally hydraulic, with electrovalves distributor and stabilizers levers, and it is located on the frame.



It is not possible to use two different control station at the same time.

The system will select as actual control station the first one that will be used by the operator. Once the AUTEK radio control station is connected, it will become the actual control station, and in order to select a different control station you need to turn off and back on the system by the ignition key or any of the emergency buttons on the machine (except the one on AUTEK radio control).

3.2.1 ▶ Platform (operating) control station

The main platform (operating) control station consists of the AUTEK radio control.

It can be activated only by carrying out the connection procedure described below (radio control activation directly excludes the basket control station).

☞ Radio control link procedure:

1. To connect the radio control, press the green Start/Link button **SL** (Picture 7) down on the left side.



Picture 7: start/link button on radio control.

2. if the radio control is not correctly connected to the machine, the green led on the upper right side of the LED panel flashes intermittently and a buzzer on the electric box emits an intermittent acoustic signal.
3. press the start/link button again: when the connection is complete, the buzzer stops and the green led starts to light up at the rate of two flashes interspersed with a pause.

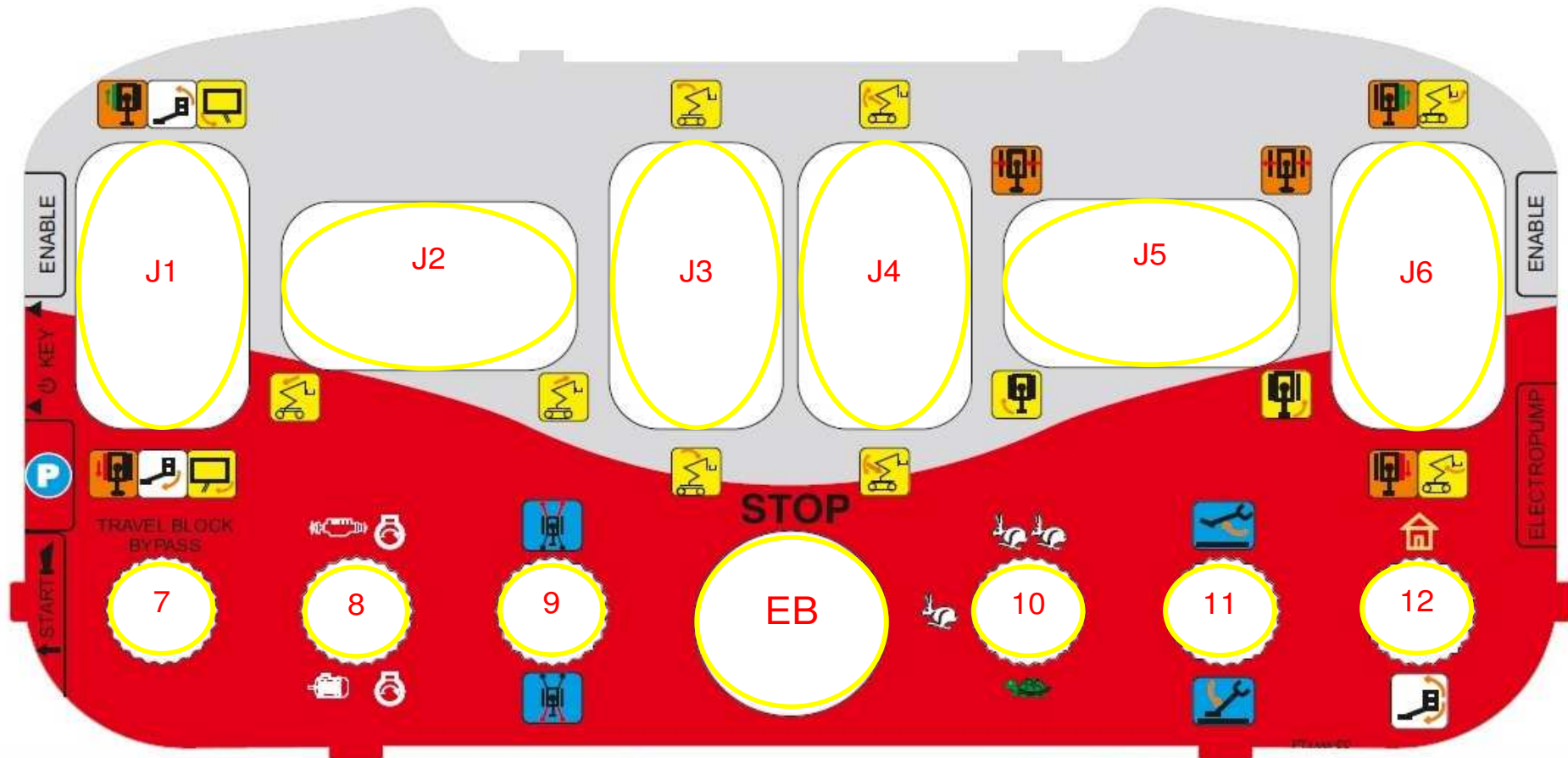

Picture 8: radio control station.



It has the following commands:

- on the left side:
 - **a green start/link key;**
 - **a blue coding key CK** (Picture 14), which puts the console in communication with the machine control unit. Be careful not to lose it!
 - **parking button P**: it has multiple functions; one of the most important is the automatic return of the booms in the rest position.
- on the central electronic panel:
 - **joystick J1** for travel of left track (orange) / basket levelling (white) / basket rotation (yellow);
 - **joystick J2** for simultaneous widening/narrowing of all tracks (orange) / telescopic boom extraction/return (yellow);
 - **joystick J3** for boom lifting/lowering (yellow);
 - **joystick J4** for lifting/lowering and extraction/return of pantograph (yellow);
 - **joystick J5** for simultaneous widening/narrowing of all tracks (orange) / turret rotation (yellow);
 - **joystick J6** for travel of right track (orange) / jib lifting/lowering;
 - **emergency red mushroom-shaped button EB** that blocks the machine, removing the power supply to the control circuits. This button has priority over all other commands; thus, it allows only manual descent to the ground. The emergency button has a mechanical locking device; therefore, it must be unlocked by turning it clockwise to reactivate the normal machine working.

- **lever 7** for travel block bypass;
- **lever 8** for endothermic or electric engine power on/off;
- **lever 9** for lowering/raising stabilizers during loading/unloading operations;
- **travel speed selector 10**: “turtle” mode = slow speed, “hare mode” = medium speed, “double hare” mode = high speed;
- **lever 11** for automatic stabilization/destabilization;
- **lever 12** for “Home function” / basket levelling (dead man device).



Carry out the basket levelling operation only when the aerial part of the MEWP is in transport configuration.



It is strictly forbidden to carry out the basket levelling operation when the machine is developed.

- on the right side:
 - **electropump activation button.**

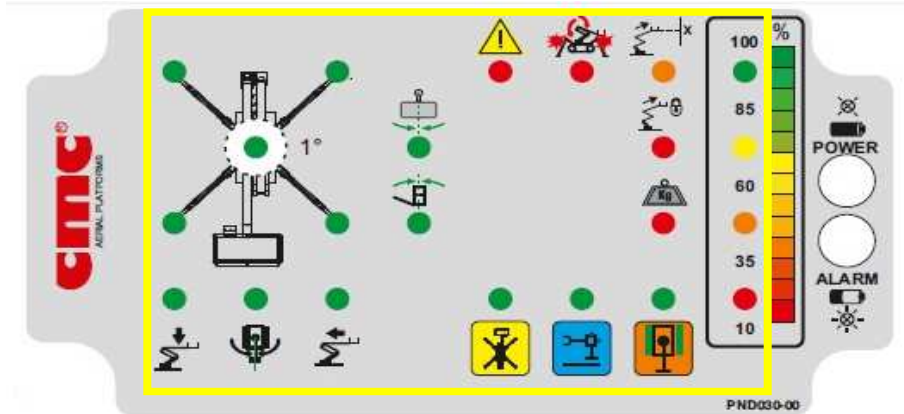

Picture 9: LED panel with indicator lights.

1		3		5	6	7	8
	10		12			15	16
17		19	20			23	24
25	26	27		29	30	31	32

Table 1: assignment number for LEDs matrix.

1. LED – LEFT FRONT STABILIZER TO THE GROUND
- 2.
3. LED – RIGHT FRONT STABILIZER TO THE GROUND
- 4.
5. LED – DANGER/GENERIC FAULT
6. WARNING LIGHT - ANTICRASH
7. EARLY WARNING LIGHT - MOMENT LIMITER
8. LED – 85-100% BATTERY CHARGE (*optional)
- 9.
10. LED – FRAME LEVELLED
- 11.
12. LED – BASKET CENTRED
- 13.
- 14.
15. WARNING LIGHT – MOMENT LIMITER BLOCK
16. LED – 60-85% BATTERY CHARGE (*optional)

17. LEFT REAR STABILIZER TO THE GROUND
- 18.
19. RIGHT REAR STABILIZER TO THE GROUND
20. LED – BASKET LEVELLED
- 21.
- 22.
23. LED – BASKET OVERLOAD
24. LED – 35-60% BATTERY CHARGE (*optional)
25. LED – BOOMS CLOSED
26. LED – TURRET CENTRED
27. LED – BOOMS WITHDRAWN
- 28.
29. LED – AERIAL PART USE CONSENT
30. LED – MACHINE STABILIZED
31. LED – MACHINE READY TO TRAVEL
32. LED – 10-35% BATTERY CHARGE (*optional).



If all leds of battery* charge flash, a battery malfunction or a connection missed (CAN-bus) is signalled.



If only the bottom led (10%) flashes, the battery* charge is too low (under minimum threshold) and the machine is near to go in block.

3.2.1.1 ▶ Recharge of radio control battery

The radio control is equipped with two interchangeable batteries (one mounted and one spare).

It is advisable to always keep the unused battery charged and, in any case, to ensure that it is being charged during non-working hours.

To charge the battery, simply allocate it in the charging compartment of the radio control storage location (Picture 10).

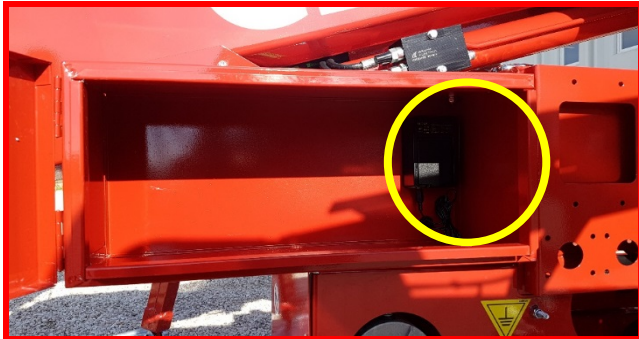

Picture 10: charging compartment of the radio control battery.

If, during works, the battery of the AUTECH radio control is low, it could become a wired remote control by cabling its plug to the frame connector or to the basket connector (Picture 11).



Picture 11: frame and basket connectors for wired remote control.

3.2.2 ▶ Basket (operating) control station



The functions contained on the basket control station are the same as those of the platform (operating) control station in Picture 8 and are indicated by the same symbols described above.

In the basket (operating) control station, clearly, the parking button **P** and the lever **7** are missing.

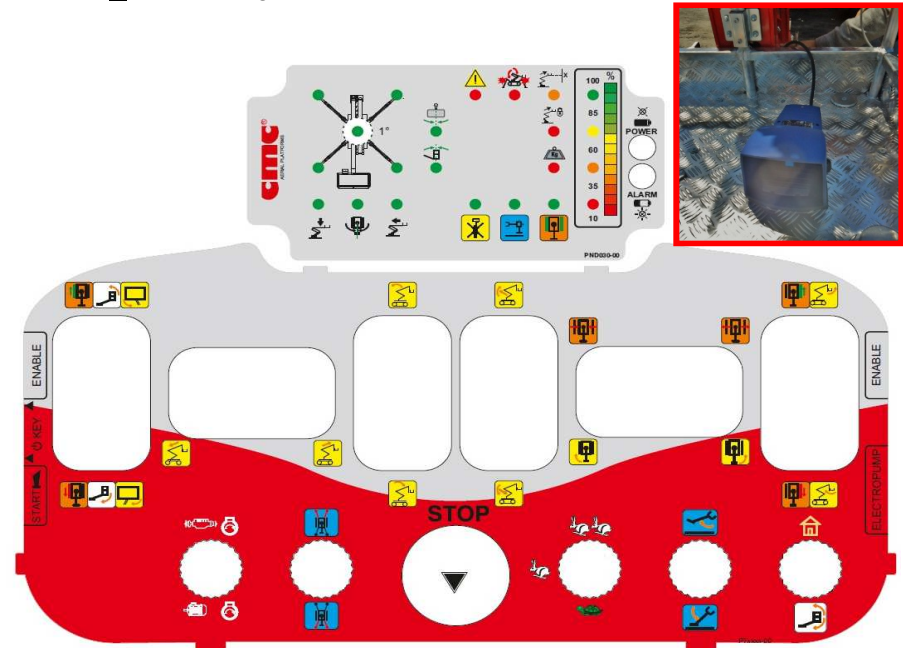

Picture 12: basket control station + “dead man” pedal.



The “dead man” pedal (*optional) must be pressed simultaneously with joysticks for all manoeuvres by the basket control station.



3.3 ▶ Emergency control stations ◀

The emergency control station includes:

- outriggers control station;
- errors display;
- emergency workbench for recovery procedure.

3.3.1 ▶ Outriggers control station

The "outriggers control station" is fixed aboard the machine frame. The manual stabilization/destabilization manoeuvres are carried out by the operator on the ground through the **stabilizers control levers** (Picture 13):

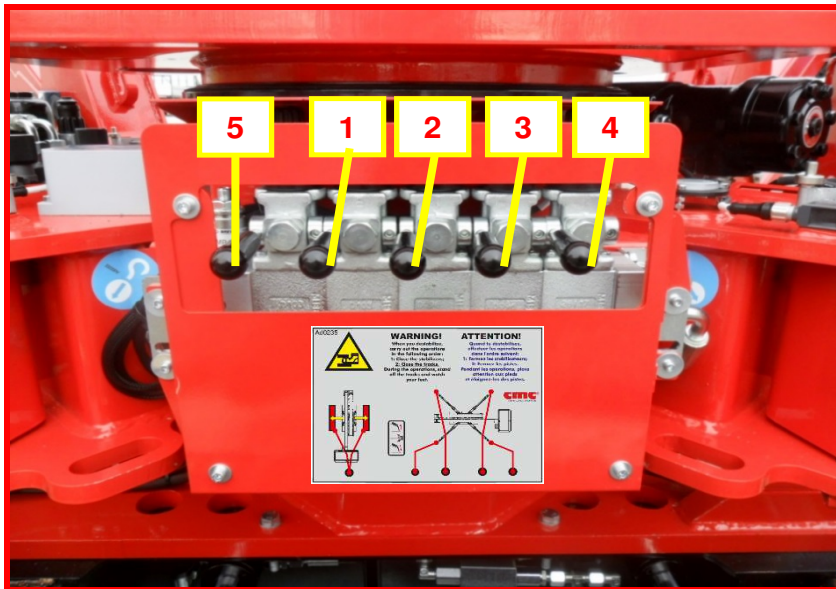

Picture 13: outriggers control station.

- lever **1** for left rear stabilizer;

- lever **2** for right rear stabilizer;
- lever **3** for left front stabilizer;
- lever **4** for right front stabilizer;
- lever **5** for tracks: it, upward, restricts the tracks and downward enlarge them.

Each lever, moved upward, runs the lifting of the stabilizer and if moved downward the lowering of it.

The "dead man" stabilizers button **9 (Picture 4) must be held pressed together with the levers of outriggers control station to stabilize or destabilize.**

3.3.2 ▶ Display

The display (Picture 14), placed at left side of the machine frame, near the outriggers control station, shows the machine status when there is any anomaly or system error.



Picture 14: display.

☞ **Communicate the error code shown on the display, when you require technical assistance to C.M.C. Service or authorized workshops.**

3.3.3 ▶ **Emergency workbench**

The emergency workbench (Picture 15) is placed on the turret and it is useful in situations of emergency and machine block for the recovery of the MEWP aerial part by the operator on the ground.



Picture 15: emergency workbench with the main hydraulic distributor.

The functions of the different cursors will be described in the section about recovery procedures through the use of the manual pump (par. 4.5.5).



4 Use procedures

4.1 Environmental operating conditions

The equipment can work normally in the following environmental conditions (for uses in different conditions, a special equipment is required):

- **temperature from -20 °C (-4 °F) to +55 °C (131 °F)** (even +70°C (158 °F) for short periods which do not exceed 24 h);
- humidity from 30% to 90% (at 20 °C);
- **max wind speed 12,5 m/s (45 Km/h - 27,96 mph).**

Do not cover the equipment with cloths in order to avoid condensation inside the electrical boards.
After storage in closed and very wet places for a long period, the machine could have some problems due to condensation in the electrical boards: in this case, should this occur, please contact the C.M.C. Service before use.



Do not work in areas with dangerous environmental conditions: poor visibility, storms, lightning risk, etc.



Do not to operate inside refrigerating rooms.



Do not work when the wind speed exceeds a 12,5 m/s (45 Km/h).
We hereby enclose the Beaufort wind scale (Table 2):

Wind power		Wind speed		Land conditions
Beaufort number	description	m/s	Km/h	
0	Calm	0-0,2	1	Calm. Smoke rises vertically
1	Light air	0,3-1,5	1-5	Wind motion visible in smoke.
2	Light breeze	1,6-3,3	6-11	Wind felt on exposed skin. Leaves rustle
3	Gentle breeze	3,4-5,4	12-19	Leaves and smaller twigs in constant motion.
4	Moderate breeze	5,5-7,9	10-28	Dust and loose paper raised. Small branches begin to move. Dust and loose paper raised. Small branches begin to move.
5	Fresh breeze	8-10,7	29-38	Branches of a moderate size move. Small trees begin to sway.
6	Strong breeze	10,8-13,8	39-49	Large branches in motion. Umbrella use becomes difficult.
7	Near gale	13,9-17,1	50-61	Whole trees in motion. Effort needed to walk against the wind
8	Gale	17,2-20,2	62-74	Twigs broken from trees. It is difficult to move
9	Severe gale	20,3-24,4	75-88	Light damages to buildings, tiles removed
10	Storm	24,5-28,4	>89	Trees are broken off or uprooted, heavy damages to buildings

Table 2: Beaufort wind scale.



We recommend the use of an anemometer, to determine direction and speed of wind.



4.2 ▶ Safety distances ◀

Below there are the safety distances to be kept by qualified staff (alternating current):

Voltage field of electric line	Minimum safety distance
Up to 300 V	Avoid contact
300 V < x > 750 V	1 ft. 0 in. (30,5 cm)
750 V < x > 2 kV	1 ft. 6 in. (46 cm)
2 kV, < x > 15 kV	2 ft. 0 in. (61 cm)
15 kV < x > 37 kV	3 ft. 0 in. (91 cm)
37 kV < x > 87.5 kV	3 ft. 6 in. (107 cm)
87.5 kV < x > 121 kV	4 ft. 0 in. (122 cm)
121 kV < x > 140 kV	4 ft. 6 in. (137 cm)

4.3 ▶ Transport, storage and packaging ◀

In order to load/unload the platform, it is possible to use a travelling crane of adequate capacity, sling the MEWP by the coupling on the chassis and on stabilizers (Picture 16).

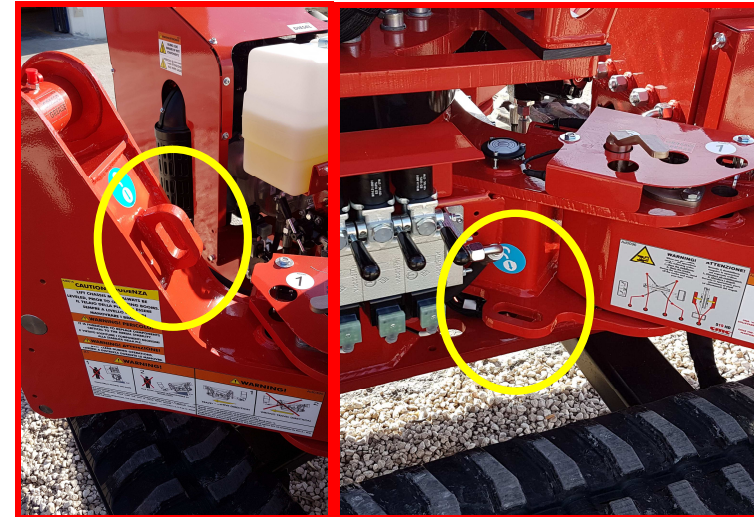

Picture 16: hooks for sling and lifting.

- ☞ The lifting operations must always be carried out with the machine closed.
- ☞ Be careful not to damage the machine.
- ☞ Always use the needed personal protection equipment; do not handle ropes or chains without gloves.
- ☞ The presence of people in proximity of MEWP during the operations is forbidden.

Alternatively, the loading/unloading can be done through ramp, exploiting the motricity of the machine as well as its ability to overcome slopes (attack) not > 31° (60%). If you choose this option, please proceed with the following procedure, and carefully reading the danger notes suggested.



☞ Comply with the rules in force about width, height, weight and transport speed allowed.
Check that the limit gauge is compatible with the features of the route to be made (i.e. galleries, bridges, electrical and phone lines, etc.).



Always use the radio control for loading/unloading operations.



WARNING! In both cases, it is advisable to remove the basket to reduce encumbrances and favor the operations.

4.3.1 ▶ Loading/unloading through ramp



Check that no one is in proximity and that the MEWP is in transport configuration.



In order to ensure a better stability during loading/uploading operations, it is possible to extract the tracks (*optional) widening the ground encumbrance, moving to the right the joystick **J5** on the radio control (Picture 8).



Place the couple of ramps (of adequate dimensions) and bring them in correspondence of the machine tracks.



Check that the ramps slope does not exceed 17° (31%) and that those are perfectly clean from grease, mud, snow or ice.



WARNING! If you get the machine on a truck, secure the machine to the truck plane by couplings on the chassis. Switch off the machine during the transport.

1. Switch on the MEWP engine.
2. Use the radio control.
3. **Check that the ramp attack is not higher than 31° (60%)** to avoid damage to carpentry and that the soil is perfectly clean from grease, mud, snow or ice.
4. Travel and climb with the MEWP set as shown below: the basket shall always be placed at the rear of the machine.

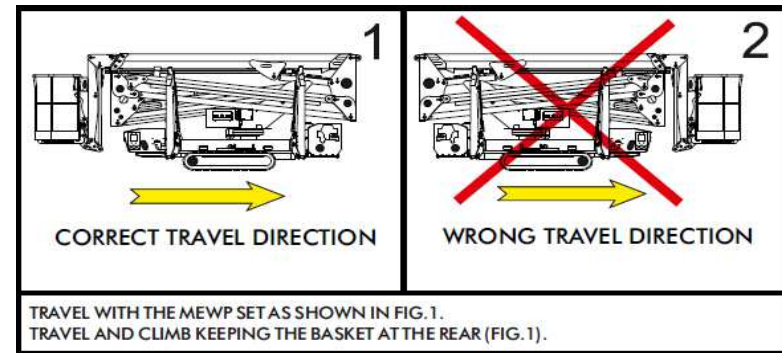

In order to favor machine loading/unloading through ramp, with the MEWP in transport position, even if it is not stabilized, you can press the parking button **P** (Picture 8) to:

- lift/lower the jib;
- rotate and level the basket;
- return the booms on their support.

4.3.2 ▶ "Self-loading" function



Check that no one is in proximity.

- Drive and block the truck or the trailer in the position chosen for MEWP loading.
- Perform stabilization of the S19HD using the procedure defined in paragraph 4.4.2.
- Drive the truck, bringing it from position 1 to position 2;

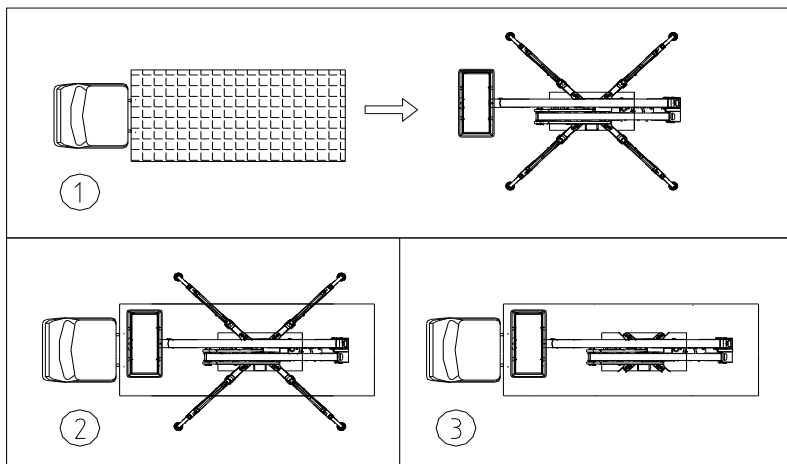

In order to avoid the overturning of the MEWP, use the roll-over control lever **9** (Picture 8), present on radio control station: it moves front or rear outriggers closer to the ground.



Do not use the outriggers to lift the truck. Stabilizer cylinders could damage irredeemably.

- Carry out the destabilization of the S19HD using the procedure defined in paragraph 4.4.6 in order to obtain the configuration 3;
- Secure the MEWP to the truck, using couplings on the frame and on stabilizers.

4.3.3 ▶ Travel

The machine, thanks to a variable flow engine, has three levels of speed identified by three different symbols:

- "turtle": minimum speed;
- "hare": average speed;
- "double hare": maximum speed.



Check that no one is in proximity and that the MEWP is in transport configuration.



In order to ensure a better stability during travel operations, it is possible to extract the tracks widening the ground encumbrance.



Check that the travel slope does not exceed the maximum longitudinal limit of 17° (31%) and the maximum transversal limit of 10° (18%). Check that the soil is clean from grease, mud, snow or ice.



WARNING! The hydraulic system for the maximum speed ("double hare") activation is a serial system. Therefore, it may be necessary to intervene with manual corrections during handling. Be very careful to travel with maximum speed!



During travel, if necessary, the parking button **P allows to lift the boom in order to avoid obstacles or its contact with the ground; moreover, it is possible lower two front stabilizers or two rear stabilizers until to brush up against the soil, using the lever **9** (Picture 8) to balance the weight of the machine.**

Travel operations shall be made with the basket placed at the rear of the machine.



Always use the radio control for travel operations.



The travel slope limits are lower from the basket control station: 11° (pre-alarm at 8°) longitudinally and 5° (pre-alarm at 2°) transversally.



When traveling, respect a distance of at least 4 meters and make sure that no one stays within a radius of at least 5 meters.



4.3.3.1 ▶ Travel using radio control

In order to perform a travel, using the radio control:

1. make sure all outriggers are raised off the ground;
2. make sure the basket block pin is inserted (Picture 19);
3. make sure the booms are returned and on their support;
4. turn on the machine (par. 3.1);
5. use the joysticks **J1** and **J6** (Picture 17) to drive the tracks;
6. position the speed selector **SS** (Picture 17) on "turtle" symbol; move it to "hare" symbol to increase the speed of the tracks or to "double hare" to reach the maximum speed.

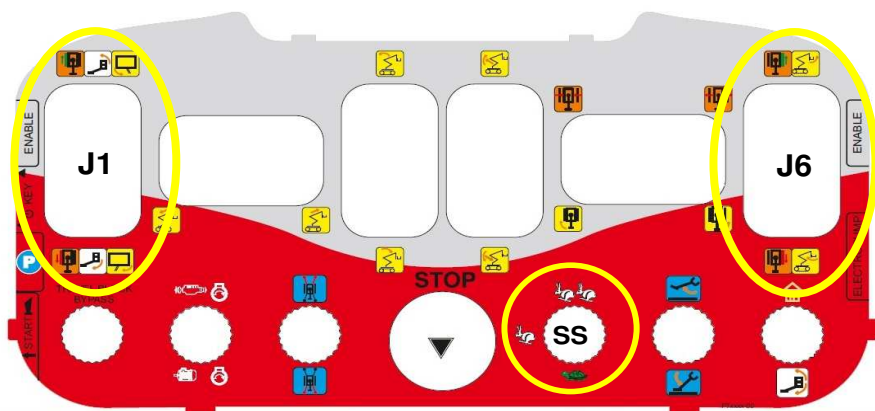

Picture 17: travel commands on radio control station.



WARNING! The S19HD machine can travel on a maximum inclination of 17° (31%), using the radio control.

During travels, when reaching a 14° slope longitudinally and a 7° slope transversally (pre-alarm thresholds), an intermittent acoustic warning will activate; it becomes a fixed acoustic signal at 17° longitudinally or at 10° transversally (maximum alarm limits), in order to indicate the PROHIBITION TO KEEP ON INCREASING INCLINATION FURTHER. If the operator continues, reaching max allowed levels, the machine will inevitably go into total block.

🔑 Procedure for bypass of travel block:

It is possible to bypass this block ONLY THROUGH OPERATIONS UNDER THE FULL RESPONSIBILITY OF THE USER, who can proceed as below:

1. move upward the lever **7** (Picture 17), placed on the left down-side of the radio control;
2. travel the machine using joysticks **J1** and **J6**.

The bypass, at this point, will be active and the operator will be able to take the machine back to the conditions prior to the block (travel in the original direction), until stopping the previously activated acoustic warning.

C.M.C. DECLINES ANY TYPE OF RESPONSIBILITY TO THE OPERATOR. THE MANUFACTURER HAS CLEARLY ESTABLISHED TWO ACOUSTIC WARNING THRESHOLDS, IN ORDER TO FULLY INFORM THE USER ABOUT THE DANGERS DUE TO THE NON-RECOMMENDED ACHIEVEMENT OF TRAVEL SLOPE LIMIT.

4.4 ▶ MEWP use procedures ◀

The machine is equipped with the "SCS System" (Self Control System) which allows:

- automatic stabilization,
- automatic speed control,
- automatic closing of the aerial part.



The following procedures must be scrupulously and chronologically respected.



If full lithium version (*optional), before any work start, check the battery charge level. It is necessary to have at least 75% of battery charge, otherwise it is advisable to charge them before working.



4.4.1 ► Placement on the working area

1. Start the machine engine through the engine ignition key supplied (Picture 4).
2. Identify the working area which is nearest to the working place.
3. Make sure the soil bears the load of the outriggers and check that there are no manholes, floors or other soft structures in the contact point of every outriggers plate with the ground.



If these conditions are not met, it is strictly forbidden to use the MEWP.

1. Place the MEWP on the chosen area, travelling by radio control (par. 4.3.3.1).
5. Mark the working area with proper signals (white-red tape, white-red chains, pins, etc.).

4.4.2 ► MEWP stabilization

The MEWP has two different stabilization areas, according to the different combinations of possible stabilizer openings. An electronic locking system uniquely ensures the chosen working configuration.



The movement of the outriggers must be possible only when the booms are resting on their supports. This condition causes the stabilization consent light **8** (Picture 4) to light up on the control stations.

6. Pull out the locking pin of the stabilizers **P** (Picture 8) from the hole;



It is forbidden, and unnecessary, to completely remove the pins from their seat.

7. rotate the stabilizer up to the hole on the stabiliser and the hole on the chassis plate are coaxial (choosing the inside for the narrow area and the outside for the wide area);
8. reinsert the pin into hole selected;
9. repeat these operations for the other three stabilizers.

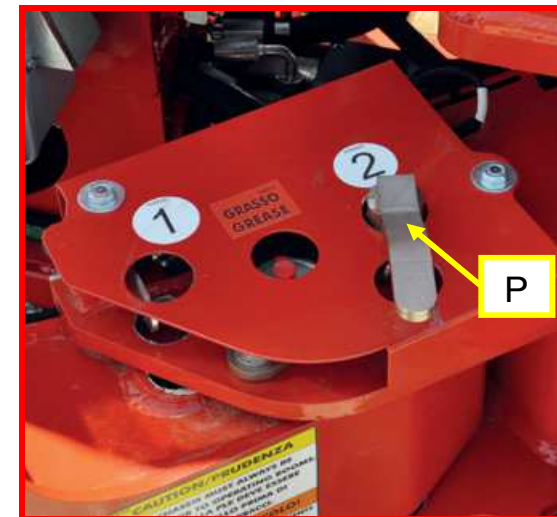

Picture 18: setting operations on stabilizers pin.



Check the status of cleanliness and integrity of the limit switches in-built in the stabilizers (cursor, bracket, spring, etc.) before the operations described above.

10. proceed to the automatic stabilization through the lever **11** (Picture 8) on radio control station or to manual stabilization by the outriggers control station (par. 3.3.1).



IT IS ESSENTIAL TO CARRY OUT THE STABILIZATION OPERATIONS BY OPERATING ON ALL FOUR LEVERS

SIMULTANEOUSLY. Once the feet will all have touched the ground, it will be possible to continue running short alternate cycles before on the two front stabilizers and then on the two rear ones.



Verify that the maximum slope to stabilize not exceed 26° (49%).

The lowering of the outriggers leads first to the contact of the four stabilizers feet with the ground and then to the lifting of the frame. Check the levelling of the machine at the bubble level (Picture 16): the maximum inclination of the frame allowed is equal to 1° (one degree). When the stabilization ends, you can see the switching on of the consent light for the aerial part **7** (Picture 4) on the ignition case.

4.4.2.1 ▶ Automatic stabilization with radio control

If you want to stabilize the machine in automatic mode, you can use the radio control:

- use the lever **11** (Picture 8): it causes the simultaneous descent of the four outriggers until the system reads the four limit switches for the ground contact and the lifting of the tracks;
- make sure that the consent indicator for the use of the aerial part **7** (Picture 4) is on.

During stabilization phase, pressing the parking button **P** (Picture 8), together the stabilization lever, you can raise all the machine without waiting the predefined cycle of automatic stabilization.

4.4.3 ▶ Access to the basket



Verify the correct assembly (Picture 19) of the basket to the jib: pivot and cotter pin inserted on the right side of the jib; pin turned to the right, up to basket edge on the left side.

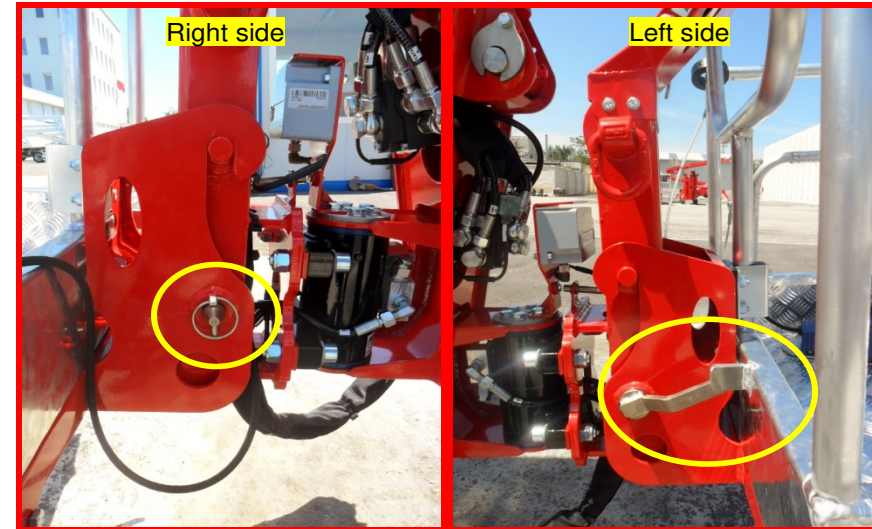

Picture 19: basket assembly.

11. Use the steps of the ladder and access inside the basket by lifting the self-locking bar.
12. **Make sure that the bar is back to the closed position; fasten the safety belts to suitable eyelets present in the basket.**

4.4.4 ▶ Levelling the basket

13. Perform the basket levelling manoeuvre to return the basket in the horizontal position if it is out of level. Using the radio control station, actuate the basket levelling control joystick **J1** and simultaneously bring down the "dead man" lever **12** in the lower right side (Picture 8).



Perform levelling only with the MEWP aerial part in transport configuration (jib closed, pantograph and booms returned, turret centered).



 It is strictly forbidden to carry out the basket levelling operation when the machine is developed.

4.4.5 ▶ Use of the aerial part

14. After making sure the aerial part consent light  (Picture 4) is on, execute the manoeuvres of the MEWP aerial part using the manipulators of the wired remote control station or the radio control station described in the paragraph 3.2.1.

 First lift the boom, in order to rise it from the support.

 It is strictly forbidden to rotate the turret as first movement, since it could seriously damage the machine carpentry.

4.4.5.1 ▶ Moment limiter

 Thanks to a moment limiting device (anti-tipping device fitted as standard on these machines), all operations bringing the machine out the working diagram are ineffective.



When the maximum allowable outreach is almost reached (90%), the pre-alarm indicator  lights up (Picture 9).

When the maximum allowable outreach is reached (see the working diagram in Picture 2), the alarm indicator  lights up (Picture 9).

4.4.5.2 ▶ Load limiter

 Moreover, when the MEWP exceeds its maximum permitted capacity (220 Kg/485 lb or 200 Kg/441 lb), the logic system detects the overload and stops the work operations, warning with a continuous acoustic signal.

During the movement of the MEWP aerial part, reaching the maximum load selected, the load limiter safety device activates:

- Overload up to 20 Kg (signaled by the lighting of the intermittent block light  – Picture 9 and by an intermittent acoustic warning): in this case, operations remain active, even if these two signals warn the user about the danger; the signals will stop only removing the overload from the basket.
- Overload > 20 kg (indicated by the fix lighting of the block light  – Picture 9 and by a continuous acoustic warning): the load limiter safety device stops all operations of the extendable structure.

➔ The operator must remove the overload from the basket to continue the work with the MEWP.

 It is strictly forbidden to use the MEWP when the load limiter warning is on. Remove the exceeding load from the basket until the acoustic signal and the relative light go out.

4.4.5.3 ▶ Slowdown of the aerial part maneuvers

Slowdowns can be set by software for start and end of each aerial part maneuver (lifting/lowering of arms, extension/retraction of arms, clockwise/anticlockwise rotation of the turret, opening/closing jib), valid in the following conditions:

- boom angle $>x^\circ$ or $<x^\circ$;
- boom extension $>x$ mm or $<x$ mm;
- opening jib $>x$ mm or $<x$ mm;
- pre-alarm condition (90% of the block);

4.4.5.4 ▶ Anti-crash system

When the machine is stabilized in the predefined areas, both with tracks resting on the ground and raised, the stabilizers with their curved structure can reach a height greater than that of the machine frame.





Furthermore, the engine pack with the fuel tank has a considerable bulk, which comes out from the rear shape of the chassis.

The anti-crash system, supplied as standard device, does not allow the aerial part (pantograph, boom, jib) to have accidental impacts with these bulky parts mounted on the frame and the stabilizers, blocking the movements operated by means of logic parameters set via software.

When activated, it is signalled by the warning light  (Figure 9) on the electronic panel of the radio control or wired remote control.



When the warning light  will be flashing and will be associated with an audible alert, the machine will be in "anti-crash block" (collision danger). In order to unlock the machine, it is necessary to press the parking button P on the radio control together with the desired manoeuvre.

If, during the descent of the pantograph or booms, the machine gets blocked (anti-crash warning light on), it will be necessary to continue the closing operations by pressing and holding the parking button  simultaneously to the desired operation. The sudden or intentional release of that button will immediately disable the operation carried out.

4.4.6 ▶ Setting the MEWP in transport configuration

15. In order to position the MEWP in the transport configuration, it is first necessary to centre the turret, then obtain the return of the telescopic boom and the pantograph on their support, using the (operating) platform control station (par. 3.2.1).



WARNING! CENTER THE TURRET BEFORE LOWERING BOOMS.

16. Unfasten the safety belts, get off from the basket using the steps below.

Keeping the parking button  (Picture 8) pressed, together the **J5** joystick which control the turret rotation, you can activate the turret self-centering up to the position 0°.

With the MEWP stabilized, pressing the parking button  (Picture 8) on radio control, it is possible return the booms.

17. Proceed to the automatic destabilization through the lever  (Picture 8) on radio control station or to manual destabilization by the outriggers control station (Picture 13).



IT IS ESSENTIAL TO CARRY OUT THE DESTABILIZATION BY OPERATING ON ALL FOUR LEVERS SIMULTANEOUSLY.

18. Once the tracks are on the ground, drive the MEWP in the storage area through the travel controls (par. 4.3.3).



If full lithium version (*optional), at the end of the work, always remember to charge batteries.

4.4.7 ▶ "Home" function



The following procedure should be carried out with the most caution and wearing all personal protective equipment.

This function is very useful at the end of works to set the platform in transport configuration.

When the appropriate button (dead man) "Home", present on the radio control station, is held pressed, the automatic closing of the aerial part is activated.



The following maneuvers must be carried out up to the limit switches in order:

- boom return up to 0°;
- turret rotation in the original direction up to 0°;
- pantograph descent up to 0°;
- boom lowering up to the support.



CAUTION! IF YOU MEET OBSTACLES DURING THE AUTOMATIC CLOSURE OF THE MACHINE, IMMEDIATELY



RELEASE THE BUTTON AND PROCEED WITH THE MANUAL MANOEUVRES.

4.4.8 ▶ Acoustic warnings

During the use of the MEWP, it is possible to hear the following acoustic warnings, corresponding to the following signals:

 SOUND	Corresponding to:
Continuous acoustic signal (intermittent in pre-alarm): when exceeding the maximum load allowed.	Load limiter light activated on basket control station and on wired remote control.
Continuous acoustic signal (intermittent in pre-alarm): when exceeding the maximum travel inclination allowed.	Maximum travel inclination light activated on basket control station and on wired remote control.

Table 3: acoustic signals.

4.5 ▶ Lithium battery pack recharge (*optional) ◀

For full lithium version (*optional), in order to recharge the battery pack, it will be necessary to stall the machine.

Then operate according to the following procedure:

1. switch off the electric engine;
2. couple the 110/120/230 V plug (power line) to the connector on the machine and press the appropriate button of the magnetothermic switch;
3. now the batteries will be in charge and the charge progress can be evaluated through the leds on chassis box or on radio control station.



The charge times are:

BATTERY CHARGE	TIME
0% - 80%	4 h
80%-100%	2 h

With a full charge (100%), the 160 Ah Eco-Battery pack is able to perform at least 10 work cycles. A work cycle includes the following sequence of operations:

- 1) stabilization;
- 2) complete machine development;
- 3) complete machine return;
- 4) destabilization.



AT THE END OF EACH WORKING SESSION AND HOWEVER AT LEAST EVERY 15 DAYS, IF THE MEWP IS NOT USED, ABSOLUTELY RECHARGE THE BATTERY PACK.



4.6 ▶ Emergency manoeuvres ◀



Before starting the emergency procedures, it could be useful to contact C.M.C. Service and communicate errors data.

In case of emergency, the controls of the MEWP aerial part should be performed by the operator on the ground.

4.6.1 ▶ Emergency buttons

In case of emergency, push the emergency button: the MEWP engine switches off and all operations are disabled. This button has priority over all other commands.

The emergency button has a mechanical locking device, therefore, to restore normal working conditions, it must be unlocked by turning it clockwise.

On the machine, there are emergency buttons in the following positions:

- on the centre of basket control station;
- on the centre of radio control station;
- on the left side of outriggers control station.

In order to secure the machine, perform the following procedures in the chronological order indicated:

1. recovery of the aerial part;
2. closing of the stabilizers;
3. retraction and travel of the tracks.

4.6.2 ▶ Emergency bypass

In case of the basket operator pressed the emergency button and were unable to reset this button at the original position (due to blackout, fainting or other), it will be possible to disable that safety function through **the “emergency bypass” under the yellow cap** (Picture 29) located on the left side of the switching on/off box.

The ground operator removes a safety lead seal and disable the emergency through **an internal on/off lever**.



It will be care and responsibility of the operators, at the end of the operations, to reset the original conditions, including the resealing with seal compulsorily branded “C.M.C.”.

4.6.3 ▶ Hydraulic system failure

In case of emergency (fuel run out and/or breakage of a hydraulic part), you can use the electric engine (*optional) or the electropump (*optional), if installed.

If the electropump is started, carry out the recovery operations through the emergency control station (Picture 15).

In case of absence of this optional, the manual pump can be used for emergency recovery of the MEWP. Bring the manual pump handle and insert it in the proper point of pumping (Picture 20).

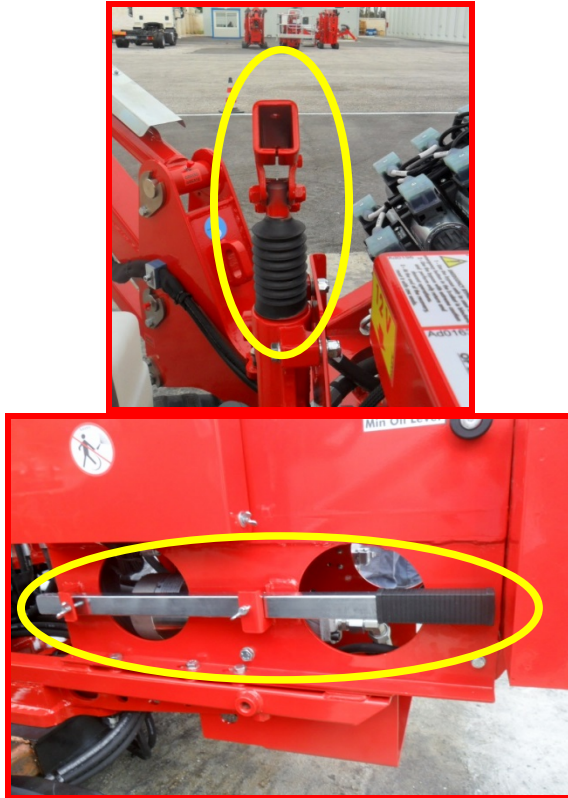

Picture 20: manual pump handle and insertion point.

4.6.4 ▶ Electric system failure

In case of electrical system failure, to obtain pressure inside the hydraulic circuit and to perform emergency recovery of the MEWP, it is necessary to activate the electropump (*optional) or, if it is not installed, the presence of two operators and the use of manual pump.

4.6.5 ▶ Simultaneous failure of hydraulic and electrical system

In case of emergency (hydraulic system failure if not available electro-pump, or simultaneous failure of the hydraulic and electrical system), to obtain the pressure inside the hydraulic circuit, you must use the manual pump.

Recovery of the aerial part:



First carry out the recovery operations of the basket, to make the operator on board safe.

1. Turn the manual pump tap (Picture 21) on the position represented by the platform symbol (fully to the left).



Picture 21: manual pump tap to be turned to the left.

- Unseal and fully screw the black knob of the tap **LFT** (Picture 22) placed at the left of the filters bench.



Picture 22: left filters bench tap.

- Unseal and screw (fully to the right) the black knob of the proportional valve **PVK** (Picture 23) of the emergency workbench.

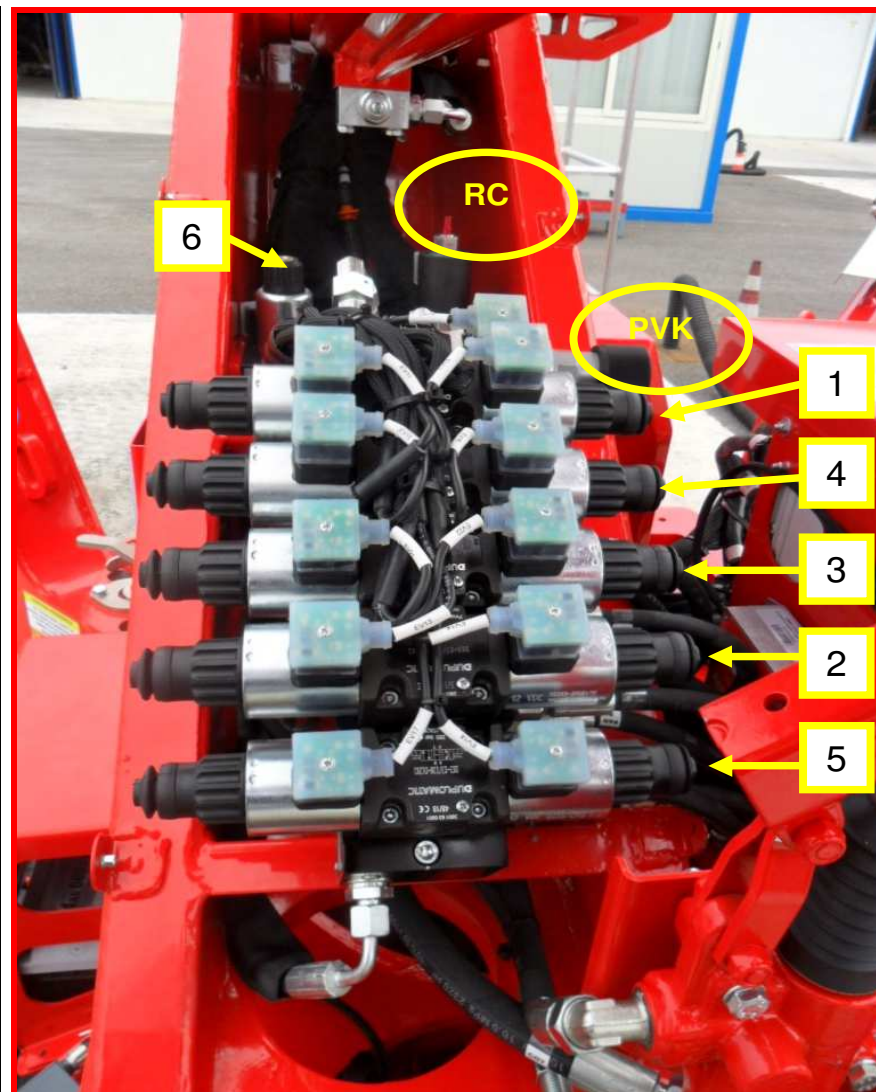

Picture 23: manoeuvres on emergency workbench.



4. Perform the aerial part recovery operations in the following sequence, by pressing the cursor of the specific maneuver (Picture 23) and simultaneously pumping oil with the manual pump:

1. jib closing 5;
2. telescopic booms return 2;
3. telescopic booms lowering 3;
4. pantograph lowering 4;
5. basket levelling 1;
6. turret rotation, keeping pressed 6 together 1.



When you have to carry out the boom lowering, it is necessary to unseal and hold pressed the red cursor of the solenoid valve RC (Picture 23).



CAUTION!! In case of emergency, first perform the retraction of the telescopic boom and then the lowering of the boom and of the pantograph.

If necessary, the basket operator can operate the basket centering first pressing the cursor of the valve in Picture 24, with a pointed object, and then moving the joystick **J6** (Picture 8) upward for counterclockwise rotation and downward for clockwise rotation.



Picture 24: valve cursor for basket centering.



While return the MEWP in rest configuration, the deceleration ramps of the maneuver speeds will be inactive: therefore, pay particular attention to the operations wearing all personal protection equipment provided by law.



At the end of aerial part recovery, it is possible to get the operators off the basket.

Recovery of the stabilizers and the tracks:

1. Turn the manual pump tap (Picture 25) on the position represented by the stabilizers symbol (fully to the right).



Picture 25: manual pump tap to be turned to the right.

2. Unseal and fully screw the black knob of the tap **RFT** (Picture 26) located at the right of the filters bench.

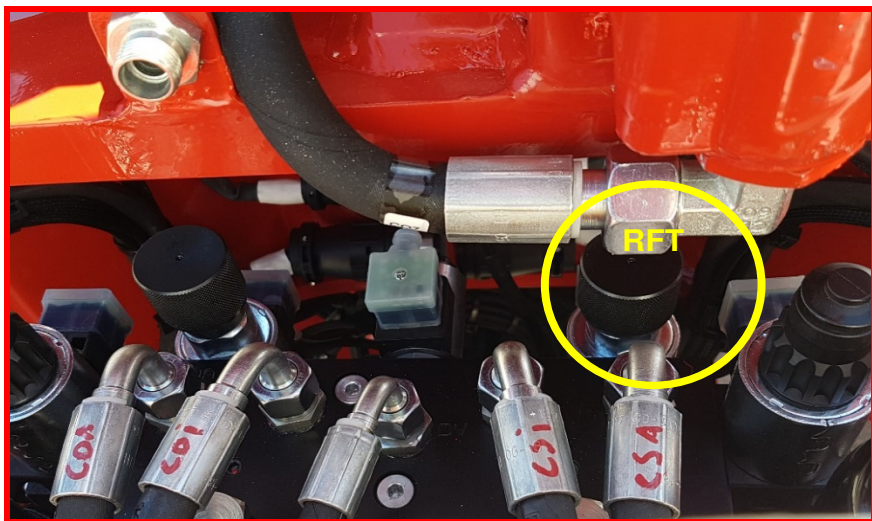

Picture 26: right filters bench tap.

3. Unseal and screw (fully to the right) the black knob of the stabilizers monitored valve **SV** (Picture 27).

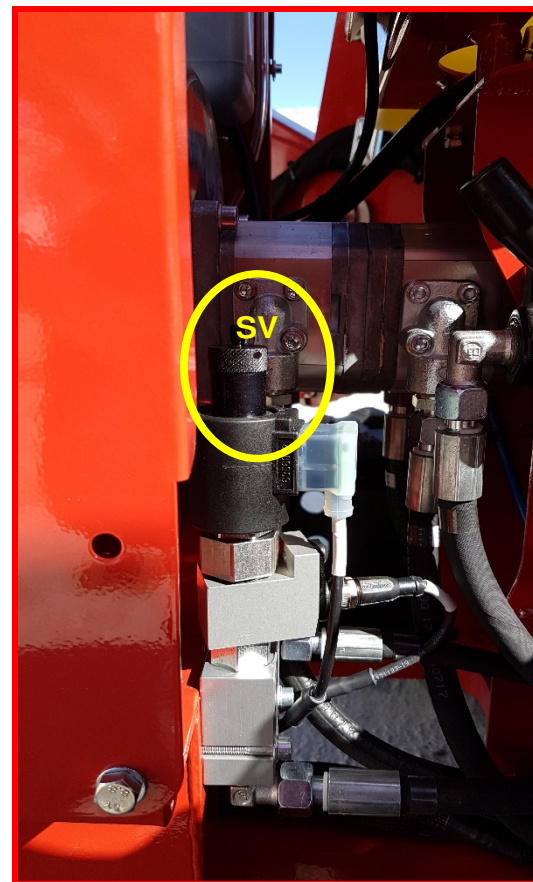

Picture 27: stabilizers valve.

While pumping oil with the manual pump:

4. Perform the stabilizers retraction through the levers **1, 2, 3, 4** of outriggers control station (Picture 13).
5. Execute the tracks re-entry moving upward the lever **5** on outriggers control station (Picture 13).



 It is strictly forbidden to use the MEWP with solenoid valves tampered or without seals.

➔ It is mandatory to restore all the sealings after use of these items.

 AFTER THE RECOVERY OF THE PLATFORM, BRING THE MEWP TO C.M.C. OR TO AN AUTHORISED WORKSHOP FOR THE RESTORING OF THE NORMAL OPERATING CONDITIONS WHICH ARE INDISPENSABLE FOR A SAFETY USE OF THE MACHINE.

4.6.6 ▶ Electropump (*optional)

The 12 V emergency electropump (Picture 28) is an alternative source of energy for the engine and should only be used in case of emergency.



Picture 28: electropump.

 ANY DIFFERENT USE IS ABSOLUTELY NOT RECOMMENDED. IN FACT, THE ELECTROPUMP, BY ABSORBING POWER DIRECTLY FROM THE BATTERY, CAN PRODUCE THE UNEXPECTED DISCHARGE OF IT.

It can be activated by:

- **button** (Picture 29) on the right side of the radio control;
- **lever** (Picture 29) under the red sealed cap, on the left side of switching on/off box.



Picture 29: electropump activation buttons.

 To activate the emergency electropump from the switching on/off control station, it will be first necessary to remove the seal on the red cap, lift it and then press the black lever below (Picture 29).

 If, in case of emergency, you activate the electropump, repeat the emergency maneuvers described above, after turning the electropump tap (Picture 30) first to the left side to recovery the aerial part and then to the right side to recovery the stabilizers.

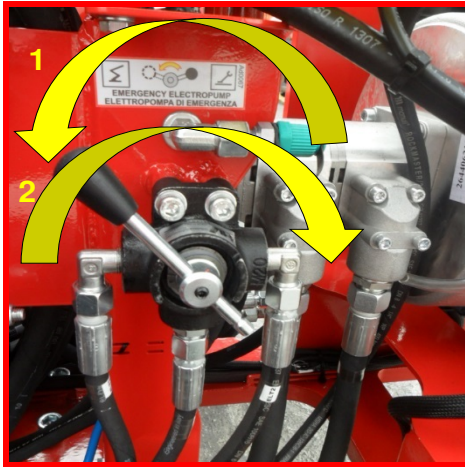

Picture 30: electropump tap.

4.7 ▶ Safety rules ◀



THE NON-COMPLIANCE WITH ANY OF THE FOLLOWING SAFETY RULES, MAY CAUSE SERIOUS DAMAGES TO PEOPLE, THINGS AND PARTS OF THE EQUIPMENT OR THE MACHINE.

4.7.1 ▶ Before and during the movements with MEWP in transport position



It is forbidden to rent the MEWP without non-trained operators and staff.

- ➔ The hirer is responsible for the training of his operators and of the staff renting the MEWP. C.M.C. s.r.l. declines any responsibility coming from damages to people and/or things due to the inexperience of these operators;



Do not use the MEWP under drug or alcohol effect;



Do not use the MEWP under stress conditions;



Do not use the MEWP if you suffer from dizzy spells;

- ➔ Before driving, check the tires wear state and the correct inflation pressure;
- ➔ Drive with caution, respecting the highway code;
- ➔ Take the MEWP height overall dimensions into consideration during circulation, in order to avoid clashing against bridges, galleries, under-passes and other obstacles;



Do not use the MEWP to perform drawing or pushing operations;



Do not use the MEWP as an off-road vehicle;

4.7.2 ▶ Before positioning the MEWP

- ➔ Carefully and chronologically follow the instructions given in this manual;



Use the MEWP only with the environmental operating conditions indicated in paragraph 4.1;

- ➔ **Check that the staff allowed to use the MEWP is skilled and trained, and that they know the MEWP use and maintenance rules;**
- ➔ Check that the safety devices are working and efficient; some components (outriggers integrated groups, max pressure valve on the turret), important for the MEWP safety, are calibrated in C.M.C. plants and the containers are sealed before delivering of the MEWP to the customer.



It is strictly forbidden to tamper with such components. The absence of the sealing within the machine warranty terms causes the immediate retraction of the warranty as well as the accountability – by the user – of the liabilities coming from an incorrect functioning of the safety devices.



Do not remove or modify safety devices;



It is forbidden to modify, remove or replace any MEWP component (ballasts, tires, batteries, spare tire etc.): this operation could reduce the machine weight thus impairing its stability;

→ Wear all the protective cloths and the personal safety devices: helmets, safety shoes and - according to the type of work - gloves, hearing protections, respirators, etc.;



Do not use clothes with hanging flaps, scarves, ties or any other accessory which could be dragged into the moving parts; inform about the closest fire-extinguishers and first-aid kit.

4.7.3 ▶ During the positioning of the MEWP



It is forbidden to operate in situations which are dangerous for the safety of people;



Do not operate in explosion hazard areas;

- Check that the working area is suitable to the MEWP performances and operations, and that it is enough lit;
- Check that the operational stands and the working area are enough lit and well visible;
- If operating in closed or little aired environment, ensure, before starting the machine engine, that his has appropriate ventilation or convey exhaust gases outside:



Exhaust emissions produced by the MEWP engine are toxic;

- Appropriately define the working area through suitable signs; observe the laws in force about the traffic, in case you use the MEWP where road circulation is allowed;
- Check that nobody is within the MEWP action range.
- Stabilize the truck through the outriggers.



Pay the utmost attention during stabilization: check that no one is inside the stabilization area.

- Check that the outriggers rest on a non-soft, solid ground that bears the load indicated on each stabilizer.
- In case of soft ground, use supporting plates.



It is forbidden to place the outriggers on ground roughness: they could be damaged.

- Level the machine in order to let the MEWP operate on a horizontal plane: max frame inclination 1° - max slope which can be assimilated by the ground 3°.

4.7.4 ▶ During the entrance in the basket



It is absolutely forbidden to use the equipment with loads different from those indicated on the diagram or for uses which are not allowed;



Do not overload the MEWP;

- **During the different working operations, the use of the safety belts is compulsory.** Do not fasten the safety belts to external structures but only to the supplied grips placed in the basket;





- Make sure that the bar lifted to enter the basket, has returned in its lock position.

4.7.5 ▶ During the use of the MEWP

- In any dangerous or irregular conditions, stop the machine by using the emergency button. Before restarting the machine, check that the dangerous conditions are over;

 It is strictly forbidden to level the basket when the machine is in working position;

 Do not operate when the MEWP is in failure;

 It is forbidden to use the “platform control (emergency) position” when there are operators inside the basket, unless there is emergency or for testing operations before starting the work (which shall be carried out without anyone in the basket): from downstairs, it is difficult to estimate how far the basket and the MEWP structure components are from possible obstacles;

- Follow the MEWP working diagram;

 It is strictly forbidden to use the platform as a crane, to hang posters, banners, poles, etc. to the basket or to any other part of the MEWP.;

 Do not connect chain or ropes to the MEWP (since they could be trapped amongst the MEWP moving parts or they could hook fixed objects thus causing the machine overturn);

 It is absolutely forbidden to lift or lower loads by using ropes and pulleys;

 It is forbidden to lean out;

 It is forbidden to use the MEWP for recreational purposes;

 Do not perform the basket rotation operation together with other operations;

 No material shall fall from above: fasten the working material properly;

 Do not throw objects (tools) upside down or vice versa.

 In case of works like pruning, plants maintenance, etc., it is forbidden to let trunks, pipes, poles etc. fall inside the basket or on the MEWP structure: they can severely impair the MEWP stability;

- During works like paintings, etc., protect yourselves and the machine;

 It is strictly forbidden to put tools, body parts in the areas marked by the stickers indicating crushing, shearing hazard; keep manuals away from any hole or slit;

 It is forbidden to use tools not complying with the laws in force;

- When working at low temperatures, it is necessary to perform some in-vain operation so that the hydraulic circuit oil reaches the operating temperature;

 It is forbidden to let people walk or stay within the MEWP working area;

 It is forbidden to stay on the counter frame floor, during MEWP operations.

- Firmly cling to the basket eyelets during lift and descent;

- Controls shall be started by slow and gradual movements;



Do not operate controls swiftly and suddenly



It is forbidden to make the platform swing;

→ Check the MEWP stability during all the operations phases;

→ Do not move the MEWP during the working operations;

→ Keep enough safety distance from the obstacles: avoid contacts with fixed (buildings, etc.) and moving (vehicles, cranes, etc.) objects, with the truck cabin, with the outriggers and with other structure parts;



It is forbidden to use ladders or tables on the basket in order to increase the MEWP outreach or working height;

→ Be careful when working in close buildings: due to the “wind tunnel” effect, sudden blasts could cause swinging, thus impairing the machine stability;



It is forbidden to lift “full surface” panels (signs, advertising panels, boards, etc.): these could cause the “sail” effect;



It is forbidden to leave the MEWP unattended when it is in working position;



It is forbidden to exceed the max number of basket operators allowed;



During the normal use of the platform, it is absolutely forbidden to use electronic instruments which do not meet the requirements of the directive 72/245/CE and its following amendments: the additional electronic instruments could impair good functioning of the platform electronic components.

4.7.6 ▶ At the end of the works

→ Before moving the machine, check that the MEWP aerial part is set in the transport position: check that the pantograph is on its own support, that the telescopic boom is withdrawn and rests on its own support;

→ Before moving the machine, check that all the outriggers are completely withdrawn and blocked, that they are set in the transport position, with the plates completely lifted.

→ Park the MEWP in the storage location.

4.8 ▶ Safety devices ◀

A - Electrical devices

- Removable key for the ignition from the chassis.
- Emergency stop buttons on the control stations.
- Basket levelling manoeuvre only allowed when the MEWP aerial part is in rest position (telescopic boom on its support).
- Microswitch blocking the outriggers controls with booms lifted and if the extension is not in withdrawn position;
- Microswitch for outriggers end-of-stroke;
- Protection fuses against brownout, both on the power circuit and on the control circuit;
- All machine controls hold-to-run;
 - Interlock stabilizers-boom manoeuvre:
 - block of the manoeuvres of the MEWP aerial part when this is not stabilized;
 - block of the manoeuvres of stabilizers return/extraction when the MEWP aerial part is not in rest position.
- Block for the extraction and the lowering of the telescopic boom to the achievement of the limit switch.
- Warning light - machine stabilized.
- Warning light - electrical supply of the MEWP.
- Moment limiter device.
- Load limiter device.



B - Hydraulic devices

- Maximum pressure valves for the protection of the entire hydraulic circuit and the individual parts of the system.
- Block valve and parachute valve mounted on the lifting cylinders.
- Manual pump for emergency operations.
- Oil flow regulator for the control of the descent speed.

C - Mechanical devices

- Hydraulically controlled negative disc brakes.
- 1,10 m height border guardrail on the basket.
- Mobile bar for basket access with gravity closing.
- Basket with safety belts eyelets.
- Mechanical blocking system of turret rotation.
- Limit switch boom centring.
- Limit switch stabilizers opening.
- Limit switch boom lifting-lowering in parking position.





All safety devices could wear out and lose their calibration, it is therefore necessary to control and keep them in perfect working order.

Do not rely totally on these devices to assess your working and safety conditions; in any case, the operator must have a proper and conscious use of the machine.

5 ▶▶ Markings ◀◀

On the machine there are the following marks.

- ➔ Before using the MEWP, it is compulsory to check the presence and the perfect readability of these marks. In case of absence or decay of the marks, contact the Service.

		C.M.C. s.r.l. Via Bitritto, 119 70124 BARI - ITALY Tel. 080 5326606/557 http://www.cmclift.com E-mail: info@cmclift.com			
TYPE	S19	MANUFACTURER	C.M.C.		
MODEL	S19HD (PRO)	YEAR			
SERIAL NR.		TOT. WEIGHT	6173 lbs		
CAPACITY	441 lbs	INCLUDING	2 persons		
MAX HYDRAULIC OPERATING PRESSURE	3336 PSI				
MAX MANUAL HORIZONTAL FORCE ALLOWED	90 lbs				
MAX WIND SPEED ALLOWED	28 mph				
MAX FRAME INCLINATION ALLOWED	1°				
EXTERNAL POWER SOURCE	230 V		50 Hz		

Picture 31: identification plate (fac-simile).

CMC XS19

Picture 32: MEWP model mark.

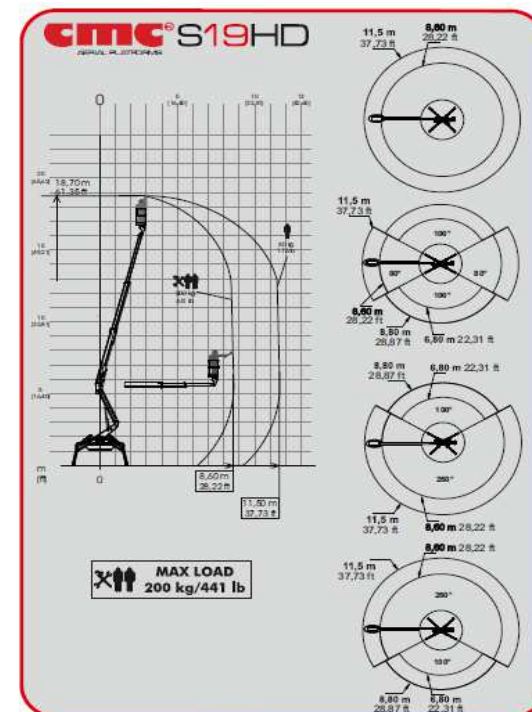

Picture 33: working diagram.

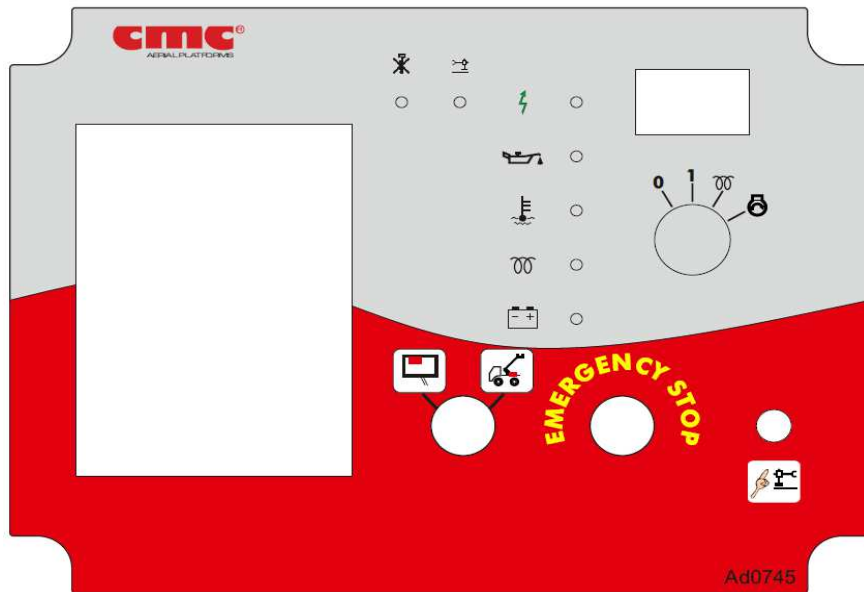

Picture 34a: switching on/off case with diesel engine.

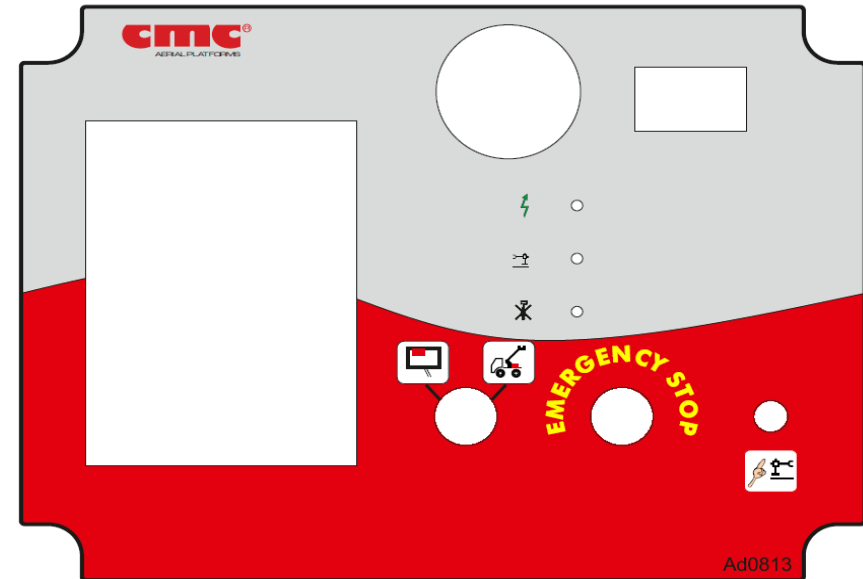

Picture 34b: switching on/off case in case of hybrid or full lithium version.

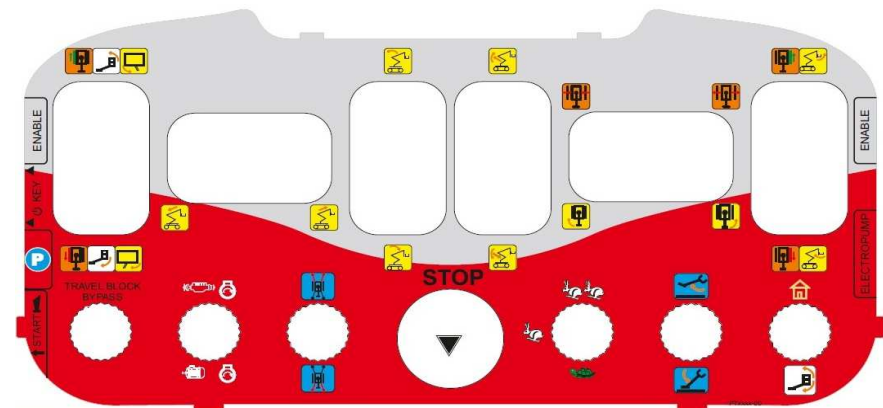

Picture 35: AUTEC radio control station.

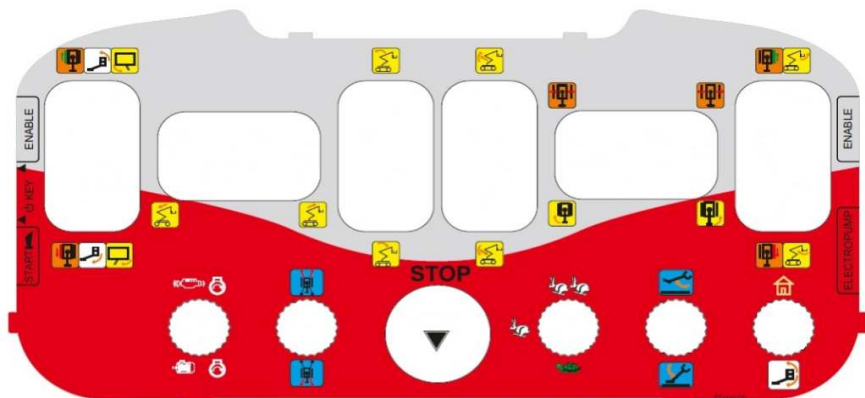

Picture 36: AUTEC wired remote control station.

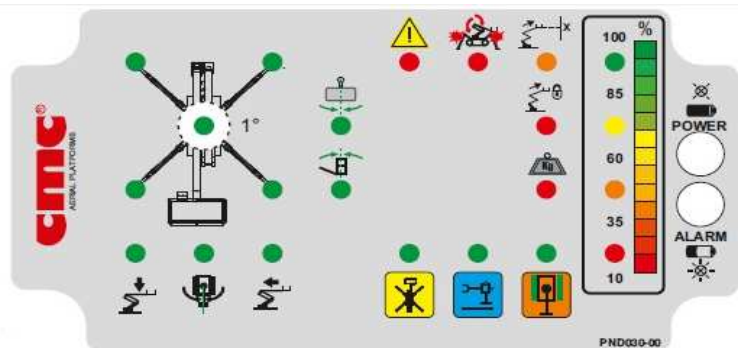

Picture 37: AUTEC electronic panel of radio/wired control station.

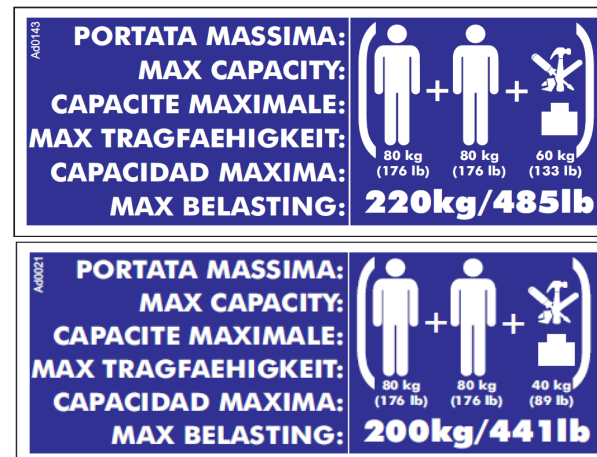

Picture 38: (alternative) maximum capacity allowed in the basket.

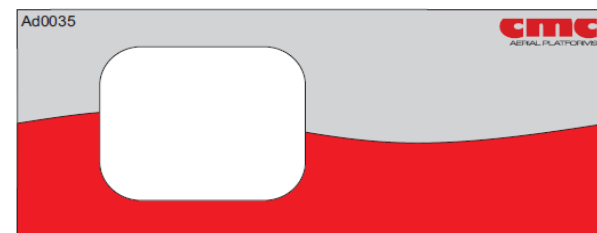

Picture 39: display box.



MACHINE STATUSES LIST/LISTE DES ÉTATS DE LA MACHINE			
NR./N°	DISPLAY CODE/ CODE SUR L'ÉCRAN	DESCRIPTION/DESCRIPTION	
20	Er	Undefined machine program	Programme machine non défini
21	Er	Undefined machine status	Statut de la machine non défini
22	C0	Transport position	Position de transport
23	C1	Machine on the tracks with the boom in the air	Machine sur le pistes avec bras ouvert
24	C2	At least one outrigger on the ground	Au moins un stabilisateur sur le sol
25	C3	At least one outrigger on the ground with the boom in the air	Au moins un stabilisateur sur le sol et avec bras ouvert
26	P0	Stabilized and inclined machine	Machine stabilisée inclinée
27	P1	Stabilized machine	Machine stabilisée
28	P2	Developed and stabilized machine	Machine stabilisée développée
29	P3	Developed and inclined machine	Machine inclinée développée
30	P4	Developed and non-stabilized machine	Machine non stabilisée développée
31	P5	Developed, non-stabilized and inclined machine	Machine inclinée, non stabilisée et développée

Ad0490

Picture 40: machine status list.

NOTICE/AVIS

Machine equipped with moment limiting device / Machine équipée de dispositif limitant le moment.

CAUTION/PRUDENCE

It is forbidden to load objects or persons during operations / C'est interdit de charger des objets ou des personnes pendant les opérations.

CAUTION/PRUDENCE

It is forbidden to stand within the platform during operations / Il est interdit de se tenir dans la zone de travail de la plate-forme pendant les opérations.

CAUTION/PRUDENCE

Use these controls only in case of emergency / Utilisez ces commandes uniquement en cas d'urgence.

WARNING/ATTENTION

Only trained staff shall operate the machine / Seul le personnel formé doit utiliser la machine.

WARNING/ATTENTION

It is forbidden to replace any component without CMC's authorization / Il est interdit de remplacer un composant sans l'autorisation de CMC.

⚠ DANGER!

**High voltage!
Haute tension!**

The platform is not electrically insulated / La plate-forme n'est pas isolée électriquement.

Keep the minimum distance from the power lines according to the table below / Respecter la distance minimale entre les lignes électriques selon le tableau ci-dessous.

Voltage/Tension	Distance	
	Feet	Meters/mètres
0 to 55 kV	10 ft	3.0 m
50 to 200 kV	15 ft	4.5 m
200 to 350 kV	20 ft	6.1 m
350 to 500 kV	25 ft	7.6 m
500 to 750 kV	35 ft	10.7 m
750 to 1000 kV	45 ft	13.7 m

Add 10 inches for every 10 kV over 50 kV
Ajouter 10 centimètres chaque 10 kV de plus de 50 kV

⚠ WARNING/ATTENTION

Center the turret before lowering the pantograph and the booms / Centrez la tourelle avant d'abaisser le pantographe et les flèches.

**MOBILE ELEVATING WORK PLATFORM USE GUIDELINES
DIRECTIVES D'UTILISATION POUR UNE PLATE-FORME DE TRAVAIL**

- IT IS THE OPERATOR'S RESPONSIBILITY TO PERFORM A SITE INSPECTION PRIOR TO SETTING UP THE OUTRIGGERS. ONLY SETUP THE MEWP ON SAFE AND SOUND GROUND / C'EST LA RESPONSABILITÉ DE L'OPÉRATEUR D'EXÉCUTER UNE INSPECTION DE SITE AVANT DE METTRE EN PLACE LES OUTRIGGERS. INSTALLER UNIQUEMENT LA PLATE-FORME SUR UNE SURFACE SÛRE ET SOLIDE.

- IT IS MANDATORY THE USE OF THE SAFETY-BELTS AND ALL APPROVED PERSONAL PROTECTION EQUIPMENT / L'UTILISATION DE BLS CEINTURIS DE SÉCURITÉ ET DE TOUT L'ÉQUIPEMENT DE PROTECTION INDIVIDUELLE EST OBLIGATOIRE.

- DO NOT USE THE MEWP AS A CRANE TO LIFT LOADS / NE PAS UTILISER LA PLATE-FORME COMME UNE GRUE POUR LÉVER LES CHARGES.

- ALWAYS FOLLOW THE INSTRUCTIONS IN USER AND MAINTENANCE MANUAL / TOUJOURS SUIVRE LES INSTRUCTIONS DU MANUEL D'UTILISATION ET DE MAINTENANCE.

Picture 41: turret instructions.



WARNING/ATTENTION

THE TRAVEL OPERATIONS FROM THE BASKET MUST BE DONE ONLY WITH THE WIRE REMOTE CONTROL! IN THIS CASE THE MAX EXCEEDABLE INCLINATION IS 11°. LIS OPERATIONS DE VOYAGE DANS LE PANIER DOIVENT NE FAITES QUE DE LA T.B.COMMANDE CÂBLÉE! DANS CE CAS, LE MAX EXCEEDABLE INCLINATION EST DE 11°.

NOTICE/AVIS

Machine equipped with moment limiting device / Machine équipée de dispositif limitant le moment.

CAUTION/PRUDENCE

Level the machine before using the aerial part / Mettre la machine à niveau avant en utilisant la partie aérienne.

NOTICE/AVIS

It is mandatory to use proper protection equipment, during operations / Il est obligatoire d'utiliser l'équipement de protection approprié.

CAUTION/PRUDENCE

It is forbidden to exceed the maximum load allowed in the basket / C'est interdit dépasser la charge maximale autorisée dans le panier.

DANGER!

High voltage! Haute tension!

The platform is not electrically insulated / La plate-forme n'est pas isolé électriquement.

Keep the minimum distance from the power line according to the table below / Respectez la distance minimale entre les lignes électriques selon le tableau ci-dessous.

Voltage/Tension	Distance	
	Feet	M (meters)
0 to 50 kV	15 ft	4.6 m
50 to 250 kV	19 ft	6.0 m
250 to 350 kV	30 ft	9.1 m
350 to 500 kV	35 ft	10.7 m
500 to 750 kV	39 ft	11.9 m
750 to 1000 kV	45 ft	13.7 m

MOBILE ELEVATING WORK PLATFORM USE GUIDELINES
DIRECTIVES D'UTILISATION POUR UNE PLATE-FORME DE TRAVAIL

- IT IS THE OPERATOR'S RESPONSIBILITY TO PERFORM A SITE INSPECTION PRIOR TO SETTING UP THE OUTRIGGERS. ONLY SETUP THE MEWP ON SAFE AND SOLID GROUND / C'EST LA RESPONSABILITE DE L'OPERATEUR D'EXECUTER UNE INSPECTION DE SITE AVANT DE METTRE EN PLACE LES OUTRIGGERS. INSTALLER UNIQUEMENT LA PLATE-FORME SUR UNE SURFACE SURE ET SOLIDE.

- IT IS MANDATORY THE USE OF THE SAFETY-BELTS AND ALL APPROVED PERSONAL PROTECTION EQUIPMENT / L'UTILISATION DES CEINTURES DE SECURITE ET DE TOUT L'EQUIPEMENT DE PROTECTION INDIVIDUELLE EST OBLIGATOIRE.

- DO NOT USE THE MEWP AS A CRANE TO LIFT LOADS / NE PAS UTILISER LA PLATE-FORME COMME UNE GRUE POUR LEVER LES CHARGES.

- ALWAYS FOLLOW THE INSTRUCTIONS IN USER AND MAINTENANCE MANUAL / TOUJOURS SUIVREZ LES INSTRUCTIONS DU MANUEL D'UTILISATION ET DE MAINTENANCE.

S19HD MAX LOAD 200 kg/441 lb

WARNING/ATTENTION

Center the turret before lowering the pantograph and the booms / Centrez la tourelle avant d'abaisser le pantographe et les flèches.

Picture 42: basket instructions.

WARNING! ATTENTION!

1 MAX. TRANSVERSAL TRAVEL SLOPE / PENTE MAXIMUM DE TRANSLATION TRANSVERSAL.

2 MAX. LONGITUDINAL TRAVEL SLOPE / PENTE MAXIMUM DE TRANSLATION LONGITUDINAL.

1 EXACT TRAVEL DIRECTION / DIRECTION DE VOYAGE EXACTE.

2 WRONG TRAVEL DIRECTION / DIRECTION DE VOYAGE ERRONEE.

IT IS MANDATORY TO CLIMB/GO DOWN WITHIN MAXIMUM VALUES SET IN FIG.1 AND FIG.2. BEFORE TRAVELLING, MAKE SURE THE WAY IS CLEAR FROM GREASE, MUD, SNOW, OR ICE. DURING TRAVEL OPERATIONS, THE OPERATOR SHALL ALWAYS KEEP AT LEAST 1,2 M (4 ft) AWAY FROM THE MEWP.

IL EST OBLIGATOIRE DE MONTER/DESCENDRE DANS LES VALEURS MAXIMALES INDIQUEE A LA FIG. ET FIG.2. AVANT DE TRANSLATION, ASSUREZ-VOUS QUE LA VOIE EST LIBRE DE LA GRAISSE, DE LA BOUE, DE LA NEIGE OU DE LA GLACE. PENDANT LA TRANSLATION, L'OPERATEUR DOIT TOUJOURS SE TROUVER AU MOINS A 4 m (13,12 ft) DE LA PTE.

TRAVEL AND CLIMB WITH THE MEWP SET AS SHOWN IN FIG.1. SE DEPLACER ET GRIMPER AVEC LA PTE REGLEE COMME INDIQUEE A LA FIG.1.

THE BASKET SHALL ALWAYS BE PLACED AT THE REAR (FIG.1). LE PANIER DOIT TOUJOURS ETRE PLACE A L'ARRIERE (FIG.1).

WARNING! ATTENTION!

1 MAX. TRANSVERSAL TRAVEL SLOPE / PENTE MAXIMUM DE TRANSLATION TRANSVERSAL.

2 MAX. LONGITUDINAL TRAVEL SLOPE / PENTE MAXIMUM DE TRANSLATION LONGITUDINAL.

1 EXACT TRAVEL DIRECTION / DIRECTION DE VOYAGE EXACTE.

2 WRONG TRAVEL DIRECTION / DIRECTION DE VOYAGE ERRONEE.

IT IS MANDATORY TO CLIMB/GO DOWN WITHIN MAXIMUM VALUES SET IN FIG.1 AND FIG.2. BEFORE TRAVELLING, MAKE SURE THE WAY IS CLEAR FROM GREASE, MUD, SNOW, OR ICE. DURING TRAVEL OPERATIONS, THE OPERATOR SHALL ALWAYS KEEP AT LEAST 1,2 M (4 ft) AWAY FROM THE MEWP.

IL EST OBLIGATOIRE DE MONTER/DESCENDRE DANS LES VALEURS MAXIMALES INDIQUEE A LA FIG. ET FIG.2. AVANT DE TRANSLATION, ASSUREZ-VOUS QUE LA VOIE EST LIBRE DE LA GRAISSE, DE LA BOUE, DE LA NEIGE OU DE LA GLACE. PENDANT LA TRANSLATION, L'OPERATEUR DOIT TOUJOURS SE TROUVER AU MOINS A 4 m (13,12 ft) DE LA PTE.

TRAVEL AND CLIMB WITH THE MEWP SET AS SHOWN IN FIG.1. SE DEPLACER ET GRIMPER AVEC LA PTE REGLEE COMME INDIQUEE A LA FIG.1.

THE BASKET SHALL ALWAYS BE PLACED AT THE REAR (FIG.1). LE PANIER DOIT TOUJOURS ETRE PLACE A L'ARRIERE (FIG.1).

Picture 43: warning for machine travel, on left/right side of frame.

Ad0165

GASOLINE

ESSENCE

Ad0042

DIESEL

Picture 44: indication of engine fuel.

Ad0018

GREASE

GRAISSE

Picture 45: indication for grease insertion.



Picture 46: indication for oil refill.



Picture 47: indication for engine oil adding.



Picture 48: indication for engine oil checking.



Picture 49: indication of minimum/maximum oil level.

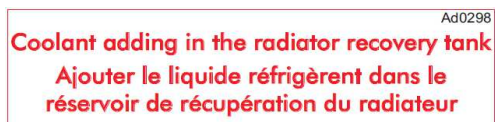

Picture 50: indication for coolant refill.



Picture 51: indication for coolant refill.



Picture 52: indication for battery cut off switch.

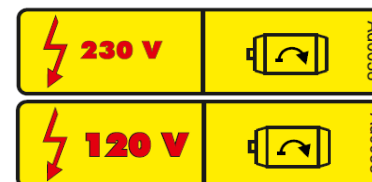

Picture 53: auxiliary (*optional) electric engines.

Ecobattery



Battery pack Ad0088

Picture 54: lithium battery pack (*optional).



Picture 55: battery pack charger (*optional).



Picture 56: indication of platform fuse.



Picture 57: obligation to read use and maintenance manual.



Picture 58: indication of basket levelling valves.

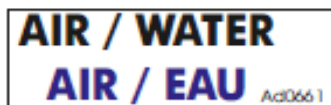

Picture 59: indication of air/water coupling.

Ad0660

Safety fall arrest belt attachment point. Stop only 1 person

Point d'attache de la ceinture de sécurité. Arrêt une seule personne

Picture 60: safety harness anchor points in basket.



Picture 61: 12 V socket in basket.



Picture 62: indication of hooking.

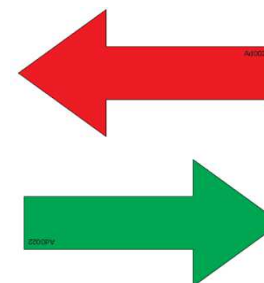

Picture 63: direction arrows on tracks for travel.

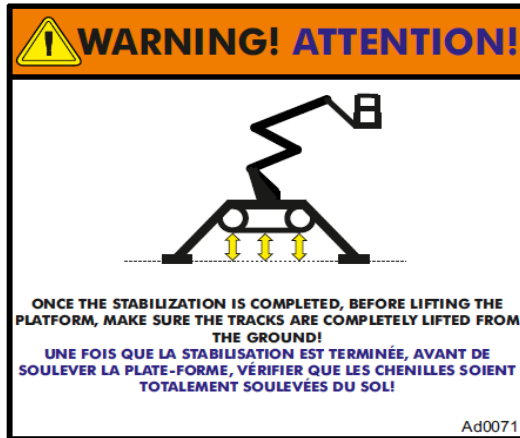

Picture 64: warning for tracks lifting.



Picture 66: general warnings on the frame.



Picture 65: generic obligations and prohibition signs.

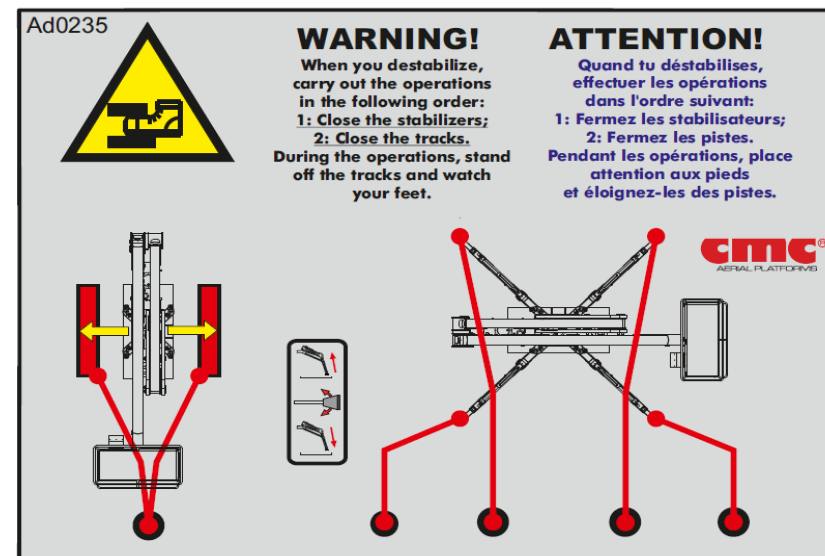

Picture 67: outriggers control station case.



Picture 68: indication of outriggers limit switch.

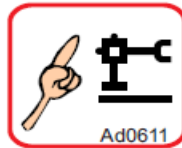

Picture 69: dead man button for stabilization.

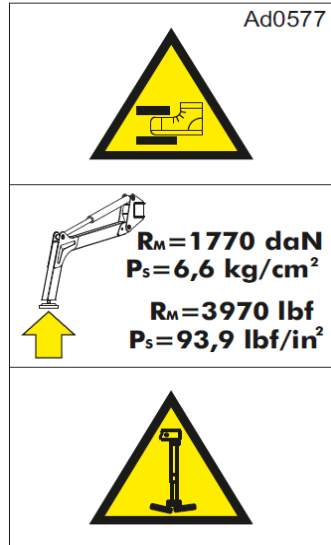

Picture 70: alert for maximum load on outriggers.

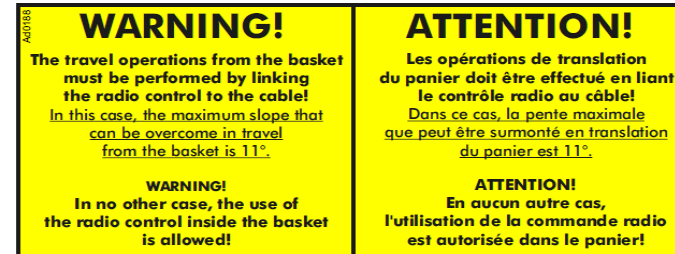

Picture 71: prohibition to use the radio control station in basket.

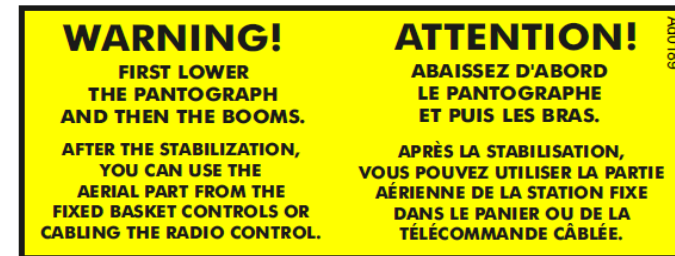

Picture 72: provision for aerial part use.



<p>Max pressure <small>Ad0108</small> 200 bar/2900 psi AERIAL PART BENCH BANCS DE LA PARTIE AERIENNE</p>	
<p>Max pressure <small>Ad0108</small> 210 bar/3046 psi FILTERS BENCH/BANC DES FILTRES</p>	
<p>Max pressure <small>Ad0108</small> 190 bar/2755 psi OUTRIGGERS BENCH BANCS DES STABILISATEURS</p>	
<p>Max pressure <small>Ad0108</small> 140 bar/2030 psi TURRET ROTATION ROTATION DE LA TOURELLE</p>	
<p>Max pressure <small>Ad0108</small> 30 bar/435 psi TRIPLE SPEED/TRIPLE VITESSE</p>	
<p>Max pressure <small>Ad0108</small> 140 bar/2030 psi LEVELING VALVE VANNE DE NIVELLEMENT</p>	
<p>Max pressure <small>Ad0108</small> 150 bar/2176 psi BOOM EXTENSION EXTENSION DU BRAS</p>	<p>Max pressure <small>Ad0108</small> 200 bar/2900 psi BOOM WITHDRAWAL RETOUR DU BRAS</p>
<p>Max pressure <small>Ad0108</small> 120 bar/1740 psi BOOM LOWERING/DESCENTE DU BRAS</p>	
<p>Max pressure <small>Ad0108</small> 120 bar/1740 psi PANTOGRAPH LOWERING DESCENTE DU PANTOGRAPHE</p>	

Picture 73: list of maximum pressures.



Picture 74: indication of insert for emergency manual pump.



Picture 75: manual pump tap.

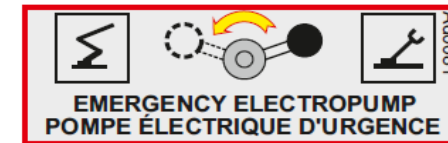

Picture 76: electropump* tap.

BYPASS D'URGENCE

- 1 - Utiliser le bypass seulement si le champignon d'urgence dans le panier est bloqué.
- 2 - Utiliser le bypass avec une extrême prudence et effectuer seulement les opérations de rentrée et sortie.
- 3 - A la fin de la reprise de la nacelle, remettre le sceaux de CMC.

EMERGENCY BYPASS

- 1 - Use the bypass only in case the emergency button in the basket is blocked.
- 2 - Use the bypass with extreme caution and perform only return and descent operations.
- 3 - At the end of the recovery, reset it with cmc seals.

Ad0317

Picture 77: indication for emergency bypass use.

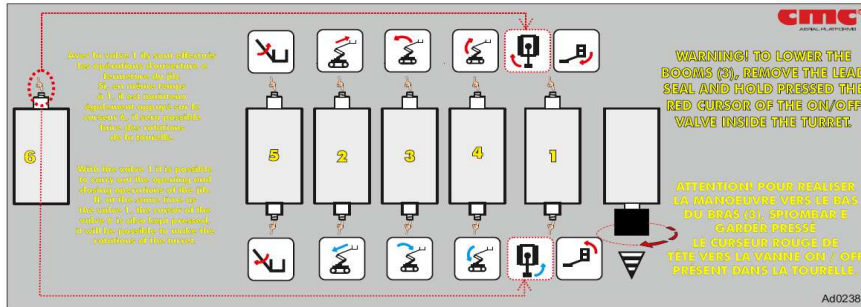

Picture 78: emergency manoeuvres.

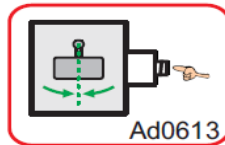

Picture 79: cursor for basket centring.



Picture 80: alert for MEWP sound power.

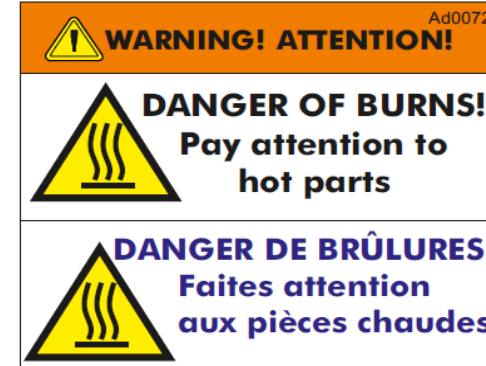

Picture 81: danger of burns.

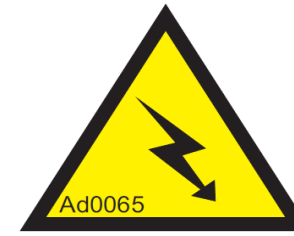

Picture 82: electric danger.



Picture 83: electric earthing.



Picture 84: shearing and cutting hazard.



Picture 85: prohibition to wet the machine.

MEWP USE GUIDELINES
DIRECTIVES D'UTILISATION DE LA PTE

CMC
APPAREILS PLATEFORME

- A daily check inspection of MEWP must be performed before its use. / Une inspection quotidienne de la PTE doit être effectuée avant son utilisation.
- The use of MEWP is allowed only to professional staff, properly trained and specialized. / L'utilisation de la PTE n'est autorisée que pour le personnel professionnel dûment formé et spécialisé.
- The operators have to check the working area before setting up the MEWP, to stabilize it on solid and safe ground surface. / Les opérateurs doivent vérifier la zone de travail avant de configurer la PTE, afin de la stabiliser sur une surface au sol solide et sûre.
- All the operators must wear the personal protection equipment. / Tous les opérateurs doivent porter l'équipement de protection individuelle.
- Do not use the MEWP as a crane to lift loads. / Ne pas utiliser la PTE comme grue pour lever des charges.
- Follow procedures described in «Use and maintenance manual». / Suivre les procédures décrites dans «Manuel d'utilisation et d'entretien».
- Travel the MEWP only when it is in transport position. / Conduisez la PTE uniquement lorsqu'elle est en position de transport.

Ad0208

Picture 86: MEWP use guidelines.

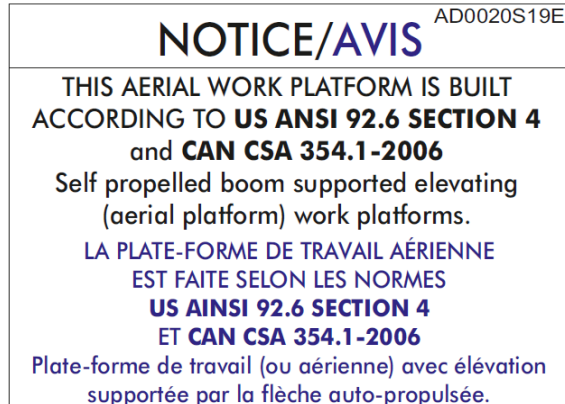

Picture 87: compliance with ANSI and CAN/CSA rules.



Picture 88: inspection tag.

6 ▶▶ Electrical system ◀◀

The MEWP is electrically supplied when the key is inserted and rotated in position 1 (Picture 4).

Periodically check the efficiency of the electrical system: battery, alternator, regulator alternator charge.

The electrical system is attached to this manual.



Any operation requiring interventions on the components of the machine, shall be carried out by authorized and trained staff.



It is forbidden to replace the components for non-authorized staff. **Many components of the MEWP have been calibrated: a correct calibration of these parts (which is possible only in C.M.C. or in authorized Services) is important to assure the safety of the machine.**

- **FUSE BOX (Picture 89):**

At view on machine switching on/off station, there is a fuse box where it is possible to find all the machine fuses. You can also identify the burnt ones through the lighting of a related spy.



Picture 89: fuse box.

FUSE BOX	
<i>Fuse 1</i>	50 KEY (ENGINE START COMMAND)
<i>Fuse 2</i>	SPARK
<i>Fuse 3</i>	POWER CHASSIS COVER
<i>Fuse 4</i>	BASKET SENSOR POWER SUPPLY
<i>Fuse 5</i>	REM SOCKET 12 V
<i>Fuse 6</i>	TURRET AND BASKET POWER SUPPLY
<i>Fuse 7</i>	CHASSIS DEVICE POWER SUPPLY
<i>Fuse 8</i>	EMERGENCY LINE 15/54
<i>Fuse 9</i>	TURRET POWER SUPPLY
<i>Fuse 10</i>	STOP ENGINE

Table 3: fuse functions.



7 ▶▶ Hydraulic system ◀◀

The MEWP hydraulic system is attached to this manual.

The pressure setting of the relief valves must correspond to the following values:

Data	Value	Unit of measure
Filters group	3046 (210)	psi (bar)
Aerial part workbench	2901 (200)	psi (bar)
Outriggers workbench	2756 (190)	psi (bar)
Levelling	2031 (140)	psi (bar)
Turret rotation	2031 (140)	psi (bar)
Pantograph descent	1740 (120)	psi (bar)
Boom descent	1740 (120)	psi (bar)
Boom extension	2176 (150)	psi (bar)
Boom withdrawal	2901 (200)	psi (bar)
Triple speed	435 (30)	psi (bar)

A radiator can be provided as *optional for cooling the hydraulic circuit oil.



All the operations requiring the intervention on the components of the machine, shall be carried out by authorized and trained technical staff.



Non-authorized staff shall not replace any of the components. **Many components have been calibrated: a correct calibration of these parts (possible only in C.M.C. or in authorized Services) is necessary to ensure the safety of the machine.**



8 Maintenance

Working in safety also means working with equipment in accordance with law standards and under constant control.

Then, the employer must:

- select proper equipment, adapted to the environment and working conditions and to the characteristics of the worker who implements it;
- supervise that it is used appropriately, and that specific training is provided to workers;
- ensure that the work equipment is:
 - installed and used in accordance with the use instructions;
 - subject to proper maintenance in order to guarantee the permanence of the safety requirements
 - subject to the update of the minimum safety requirements established with international specific regulations.

A correct use of the platform and a regular maintenance are crucial to keep it always in the best working, efficiency and safety conditions. The frequent washing of the equipment by high-pressure water jet machines is crucial to get rid of the harmful remains coming from the works performed and from atmospheric agents. Before washing, set the MEWP in driving position, stall the engine and take off the batteries.

To document what has been done, the employer is therefore required to draw up and update the appropriate equipment control register.



Carefully read and scrupulously follow the maintenance instructions and safety laws during the maintenance.

The operations indicated with **USER** are to be performed by the user. The operations indicated with **C.M.C.** shall be performed only by C.M.C. srl or in authorized repair shops. Use only C.M.C. original spare parts (even if on the market there are equivalent or similar parts).

The frequency of the maintenances is indicated in every table. It is implied a normal use of the equipment; while, for particularly rough uses or in harmful environments (presence of dust, sand, etc.), an optimal maintenance frequency is left to the good sense of the user.



If an intervention that is different from the following ones is necessary, ask the C.M.C. Service for authorization and instructions.

8.1 Daily maintenance





All the following checks are to be performed running the MEWP from the emergency control station and without anyone inside the basket.

Every day, before starting the MEWP, perform the following operations:





Inspections	In case of negative outcome of the inspections:	Resolution by
Check the hydraulic oil level in the tank	Refill it	USER
Check the level of fuel in the tank	Refill it	USER
Check the coolant level	Refill it	USER
Check the state of charge of the batteries	Recharge or replace them	USER
Check the cleanliness of the treading surface : oily or fats residues, present on these surfaces may be the cause of slips;	Clean the surface	USER
Check that the warning and instruction stickers on the MEWP are not damaged or missing;	Replace and/or integrate them	USER



Inspections	In case of negative outcome of the inspections:	Resolution by
<p>Perform the following tests by acting on the controls (emergency) placed on the turret and without any person inside the basket:</p> <ul style="list-style-type: none"> ○ Lifting and lowering telescopic boom; ○ Lifting and lowering the pantograph; ○ Clockwise and anticlockwise rotation of the turret; ○ Extraction and return telescopic boom; <p>During the test manoeuvres verify that the floor of the basket always keeps a horizontal level.</p> <p>Check the operation of the stabilizers block valves, with boom not in rest position:</p> <ul style="list-style-type: none"> ○ Extend the stabilizers and level the MEWP; ○ Press the EMERGENCY button to switch off the engine; ○ Operate the stabilizers lifting and lowering lever. <p>THE STABILISERS MUST NOT MOVE.</p>	<p>In case of issues that might be resolved by following the instructions in the paragraph "drawbacks - causes - solutions" carry out the operations described in this paragraph.</p>	USER
	<p> It is strictly forbidden to use the MEWP in case of problems that cannot be resolved by following the instructions in the paragraph "drawbacks - causes - solutions". Contact the Technical Assistance Service.</p>	CMC

Inspections	In case of negative outcome of the inspections:	Resolution by
<p>Check the operation of the boom extraction cylinder lock valve:</p> <ul style="list-style-type: none"> ○ Extend the boom and place it in vertical position; ○ Press the EMERGENCY button to switch off the engine; ○ Operate the boom retraction and return lever; <p>THE BOOM MUST NOT RETURN. Check the operation of the boom lifting cylinder lock valve:</p> <ul style="list-style-type: none"> ○ stabilize the MEWP; ○ load the basket with 220 Kg (only weights). <p> During checking it is strictly prohibited to load the MEWP by placing people in the basket.</p> <ul style="list-style-type: none"> ○ Extend the telescopic boom; ○ Press the EMERGENCY button to switch off the engine; ○ Operate the lifting and lowering levers of the telescopic boom; <p>THE TELESCOPIC BOOM MUST NOT MOVE.</p>	<p>In case of issues that might be resolved by following the instructions in the paragraph "drawbacks - causes - solutions" carry out the operations described in this paragraph</p>	USER
	<p> It is strictly forbidden to use the MEWP in case of problems that cannot be resolved by following the instructions in the paragraph "drawbacks - causes - solutions". Contact the Technical Assistance Service.</p>	CMC



Inspections	In case of negative outcome of the inspections:	Resolution by
Check the absence of slits, cracks, points of rust on the structure of the MEWP.	 It is strictly forbidden to use the MEWP. Contact the Technical Assistance Service.	CMC
Check that the safety devices (emergency stop buttons, stabilizers-boom interlock System) are working perfectly.	 It is strictly forbidden to use the MEWP. Contact the Technical Assistance Service.	CMC
Check that the controls and the warning lights are working perfectly.	 It is strictly forbidden to use the MEWP. Contact the Technical Assistance Service.	CMC
Check the integrity of the tube holder chains.	 It is strictly forbidden to use the MEWP. Contact the Technical Assistance Service.	CMC
Check that the locking systems of the pins (pins, rings etc.) are in perfect conditions of conservation and efficiency.	 It is strictly forbidden to use the MEWP. Contact the Technical Assistance Service.	CMC

Inspections	In case of negative outcome of the inspections:	Resolution by
Check the integrity of the hoses, unions, and of the components of the hydraulic system: make sure that there are no oil leaks in the hydraulic system.	Replacement	USER/ CMC
Check that there are no loose electrical connections.	Restoration of the connections	USER/ CMC
Check that there are no signs of collision on the equipment.	 It is strictly forbidden to use the MEWP. Contact the Technical Assistance Service.	CMC

8.2 ▶ Weekly maintenance (or every 40 hours) ◀

Operations	by
Check the absence of slits, cracks, points of rust on the structure of the MEWP frame (use torches or lamps to inspect the internal part under the floor).	USER / CMC
Check the cleanliness condition of the air filter in the ruck and in the auxiliary motor*.	USER / CMC
Check the cleanliness of the hydraulic filters.	USER / CMC

8.3 ▶ Monthly maintenance (or every 120 hours) ◀

Operations	by
Grease the pins and movable parts.	USER / CMC
Washing the equipment.	USER / CMC
Check the tightening of the slewing ring, gear motor and frame bolts.	USER / CMC



8.4 ▶ Quarterly maintenance (or every 300 hours) ◀

Operations	by
Check the tightening of the slewing ring, gear motor and frame bolts.	USER / CMC

8.5 ▶ Maintenance after the first 400 hours ◀

Operations	by
Replace hydraulic filters.	USER / CMC
Register booms clearance.	CMC

8.6 ▶ Semi-annual maintenance (or every 750 hours) ◀

Operations	by
Replace hydraulic filters (25 micron).	USER / CMC
Complete inspection of the entire machine and recording the results in the proper section of the manual.	USER / CMC

8.7 ▶ Annual Maintenance (or every 1500 hours) ◀

Operations	by
Replacing the hydraulic oil.	CMC

As regards the replacement of hydraulic oil, it is advisable to follow the indications below:

1. Place the machine in the transport configuration and bring the oil to operating temperature by performing some manoeuvres before proceeding with the operations described below.
2. Suck the oil from the tank;
3. Remove the hydraulic filter;

4. Replace the filter;
5. Fill the tank by passing the oil through a filter with a degree of filtration equal to 25 microns.

NOTE: The dipstick to check the oil level is located inside the oil tank cap located on the floor between the turret and the rear stabilizers. The hydraulic filters are located at the sides of the stabilisers control station.

8.8 ▶ Biannual maintenance ◀

Operations	by
Complete inspection of the whole machine and recording the results in the proper section of the manual.	CMC

8.9 ▶ Five-year maintenance ◀

Operations	by
General inspection of the whole machine and recording of the results in the proper section of the manual.	CMC

8.10 ▶ Safety rules during maintenance ◀



THE NON-OBSERVANCE OF ONE OF THE FOLLOWING SAFETY RULES CAN SERIOUSLY HARM PEOPLE OR CAUSE SEVERE DAMAGES TO THINGS OR PARTS OF THE MACHINE.

➔ To ensure the safety of the machine **the use of original spare parts installed by C.M.C. or by authorized repair shops is compulsory:** in fact, some components can be calibrated only c/or C.M.C. or in authorized workshops.



It is forbidden to perform maintenance operations when the MEWP moves: make sure that the parts to maintain are motionless



and do these operations with the chassis power stalled, taking the keys away from the panel;

- ➔ Perform the maintenance operations in a sufficiently large space and suited to the sizes of the truck: mark the area assigned for the maintenance operations by suited enclosure or by a red/white band ribbon and do not allow entrance to unauthorized staff.
- ➔ Do not modify or remove safety devices.
- ➔ Do not modify calibrated pieces.
- ➔ During the washing operation, do not lead the water jet directly on the electrical panels of the MEWP and do not use cleansing, aggressive chemicals dangerous for the components of the MEWP (rubber parts, painted parts, etc.).



It is forbidden to perform any intervention on parts of the MEWP, such as welding, piercing, and so on, without prior written authorization by C.M.C.

- ➔ Wear appropriate protective clothes (gloves, goggles, etc.).
- ➔ During maintenance operations, be careful not to damage the hydraulic circuit and avoid impurities in the circuit.
- ➔ Before any maintenance operation that involves the disassembly of hydraulic circuit parts, make sure that the system is not under pressure. In order to avoid violent emissions of oil, move all the levers of the control distributors, with the MEWP engine stalled and no component in movement.

8. 11 ► Maintenance of endothermic engine ◀

The standard supplied motor has the following technical characteristics:

- *HONDA GX390 petrol engine*, single cylinder OHV with horizontal shaft, 4 strokes, cylinder inclined at 25°, forced air cooling, cast iron cylinders.

Data	Value	Unit of measure
Bore x Stroke	Ø 88 x 64	mm
Cylinder capacity	389	cm ³
Net power at 3600 rpm	8.7 (11.7)	kW (HP)
Maximum torque at 2500 rpm	26.5	N/m
Dry weight	31.7	kg
Dimensions (L x W x H)	406 x 460 x 448	mm
Fuel consumption at 3600 rpm	3.5	l/h
Fuel tank capacity	6.1	l

Other engines, provided as optional*, has the following technical characteristics:

- *HONDA iGX390 petrol engine*, single cylinder OHV with horizontal shaft, 4 strokes, cylinder inclined at 25°, forced air cooling, cast iron cylinders.

Data	Value	Unit of measure
Bore x Stroke	Ø 88 x 64	mm
Cylinder capacity	389	cm ³
Net power at 3600 rpm	8.7 (11.7)	kW (HP)
Maximum torque at 2500 rpm	26.5	N/m
Dry weight	37	kg
Dimensions (L x W x H)	409 x 484 x 448	mm
Fuel consumption at 3600 rpm	3.5	l/h
Fuel tank capacity	6.1	l

- *YANMAR L100*, air-cooled diesel engine, vertical cylinder, 4 strokes.



Data	Value	Unit of measure
Bore x Stroke	Ø 86 x 75	mm
Displacement	0.435	l
Continuous nominal power (3000 - 3600 rpm)	5.7 - 6.2	kW
Maximum nominal power (3000 - 3600 rpm)	6.3 - 6.8	kW
Dry weight	53.5	kg
Dimensions (L x W x H)	412 x 472 x 494	mm
Fuel tank capacity	5.4	l

- *Kubota Z602-E4B*, 4-cycle diesel engine, vertical, water cooled, naturally aspirated, indirect injection, 2 cylinders.

Data	Value	Unit of measure
Bore x Stroke	Ø 72 x 73.6	mm
Displacement	0.599	l
Rated Output (at 3200 rpm)	10.8 (14.5)	kW (HP)
Maximum Torque (at 2600 rpm)	37.8	Nm
Dry weight	57	kg
Dimensions (L x W x H)	351 x 401 x 544	mm
Fuel tank capacity	5.4	l

8.12 ► Maintenance of 48 V electric engine (*optional) ◀

The 48 V electric engine with battery pack, provided as optional* in full lithium version, has the following technical characteristics:

Battery specifics		
Battery Composition	LiFePo4	
Typical Capacity	160	[Ah]

Cells Configuration	15S1P	
Rated Voltage	48	[V]
Maximum Voltage Fully Charge	54.8	[V]
Minimum Operative Voltage	42	[V]
Rated Discharge Current	30	[A]
Maximum Discharge Current	100 (electronically limited)	[A]
Rated Charge Current	30 A (0.3 C)	
DoD	80	[%]
Battery Life Cycle	>2000 Cycle@80%DoD or >3000 Cycle@70%DoD	
Operative temperature (during charge)	-20/+60*	[°C]
Operative temperature (during discharge)	-20/+60	[°C]
Battery Weight	70 approximately	[kg]
Maximum Output Power	4.8	[kW]
Rated Energy	4.32	[kWh]

*When charge is operated at less than 0°C the charge current is electronically limited at 10 A.

Battery charger specifics

Voltage Input	100 - 240	Vac
Frequency Input	50 - 60	Hz
Maximum Output Voltage	>=60	V
Maximum Current	22	A
PWM Frequency	1	kHz
International Protection	IP20	
Weight	2,2	Kg
Dimension (L*W*H)	180x310x100	mm

8.13 ► Consumables ◀

Hydraulic oil:



Gazpromneft Hydraulic	HDZ ISO	32	46
Density, 15 °C, kg/l	ASTM D1298	0,867	0,872
Kinematic Viscosity, 40 °C, mm ² /s	ASTM D445	32	46
Kinematic Viscosity, 100 °C, mm ² /s	ASTM D445	6,32	8,03
Viscosity Index	ASTM D2270	151	154
Pour Point, °C	ASTM D97	-42	-42
Flash Point COC, °C	ASTM D92	204	216
Air release, 50 °C, min	ISO DIS 9120	5	6
Copper corrosion, 3 hrs, 100°C	ASTM D130	1a	1a
FZG, Damaged Load, A/8,3/90	DIN 51354	12	12

(hydraulic tank capacity: 25 l)

Grease:

- for arm extension and outriggers:
Interflon Grease LS1/2
Composition: mixture of mineral oils, calcium-lithium complex thickener, additives and Teflon®.
(working field: from -20°C to +120°C)
- for lubricators and bearing:
WHITE STAR NLGI 0 E 2
Composition: mixture of mineral oils and additives.
(working field: from -30°C to +110°C)
- for chains:
Interflon LUBE EP+
Composition: mixture of mineral and vegetable oils, additives and Teflon®.
Density, 20°C: 0,89 g/cm³
Kinematic viscosity, 20°C (ASTM D2983): 380 mPa.



Before oil replacement, place an oil drip tray in order to avoid the leakage of oil in the environment.

Do not disperse the exhausted oil or other consumables in the environment; put them in the appropriate containers and give them to the authorized collection centers.

8.14 ► Indications for the dismantling of the MEWP ◀

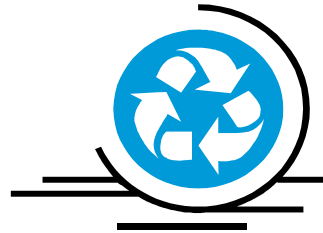

In the case of demolition, the machine is completely dismantled according to the regulations in force.



The different types of materials should be distributed to the respective authorized collection centres.

The following material must be subjected to differentiated disposal and then positioned in suitable premises and containers:

- Ferrous materials: **carpentries and mechanical components.**
- Plastic materials: **gaskets, belts, protections.**
- Electrical materials: **windings, commands, solenoid valves and similar.**
- Oils and lubricants: **hydraulic oil, reducers lubricants, lubricating greases.**

8.15 ► Service ◀

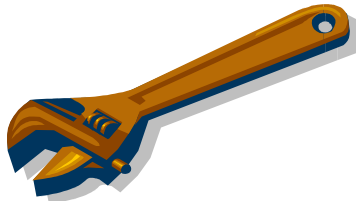

For repairs and maintenance of your platform, exclusively contact:

**Service
C.M.C. s.r.l.**

Via Bitritto, 119
70124 BARI – ITALY
Tel. +39 080 5326606
+39 080 5326557
Fax: +39 080 5368541
E-mail: info@cmclift.com

IMPORTANT

FOR ANY COMMUNICATION, PROVIDE THE TYPE AND SERIAL NUMBER OF THE MACHINE.



Any operation requiring interventions on the components of the machine shall be carried out by authorized and trained staff.



Non-authorized staff can't replace components. Many components of the MEWP have been calibrated: a correct calibration of these parts (which is possible only in C.M.C. or in authorized workshops) is necessary to ensure the safety of the machine.

8.15.1 ▶ Remote Connection System (*optional)

The remote connection system is composed of an electronic box (Picture 90) mounted on the chassis box.

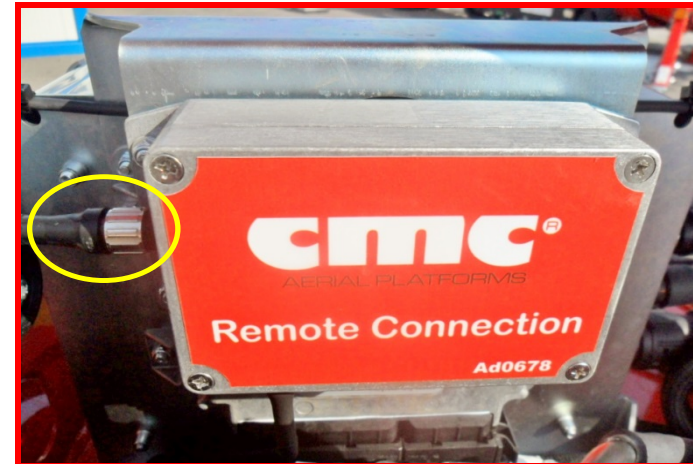

Picture 90: remote connection system.

Following the remote connection procedure:

1. Ensure that the M12 socket on the remote connection box is correctly connected to the M12 plug of the electric box mounted on the chassis;
2. Share your internet wireless network with the remote connection device in free mode (without password);
3. Lift the connection remote switch **L** on the switching on/off box (Picture 91):



Picture 91: chassis box.

- the led on the remote connection box makes two red flashes,
 - after 30 seconds, the led becomes fixed and green, to show that the operating system is working,
 - it automatically hooks up to your free network;
4. Install on your PC the TeamViewer software (11th version) to connect to the machine system, through ID and Password supplied by the manufacturer;
 5. Call C.M.C. Service for technical assistance.



9 Troubleshooting

Drawback: THE CONSENT LIGHT FOR STABILIZATION DOES NOT TURN ON.

- Causes:**
1. The aerial part of the MEWP is not in transport position.
 2. Failure fuse 30A battery side.
 3. Defective board.
 4. Wire removed from the battery.

- Remedies:**
1. Place the aerial part of the MEWP in transport position.
 2. Check if any cable is disconnected from the battery.
 3. Replace fuse.
 4. Replace the limit switches.

If the problem persists, contact the Service.

Drawback: THE STABILIZERS DO NOT WORK.

- Causes:**
1. The hydraulic pump unit is faulty.
 2. Stabilizers solenoid valve do not work.

- Remedies:**
1. Replace the hydraulic pump.
 2. Replace the stabilizers limit switches.

If the problem persists, contact the Service.

Drawback: WITH THE MEWP STABILIZED, THE CONSENT LIGHT FOR AERIAL PART USE DOES NOT TURN ON.

- Cause:**
1. The green light does not work.
 2. Micro-switch system does not work.
 3. Stabilization is incomplete.

- Remedies:**
1. Replace micro-switch.
 2. Further extract outriggers up to soil contact.

If the problem persists, contact the Service.

Drawback: THE AERIAL PART OF THE MEWP DOES NOT WORK.

- Causes:**
1. The hydraulic pump unit is faulty.
 2. The control stations are not activated.
 3. The exchange solenoid valve is not energized.
 4. Emergency button activated.

- Remedies:**
1. Replace the hydraulic pump.
 2. Turn on and connect the control station.
 3. Replace the exchange valve.
 4. Turn the emergency button and reset the MEWP.

If the problem persists, contact the Service.

Drawback: THE PLATFORM LEVELLING DOES NOT WORK.

- Causes:**
1. Oil leakage.
 2. Cylinder seals worn.

- Remedies:**
1. Tighten hydraulic connections.
 2. Replace the seals.

If the problem persists, contact the Service.

Drawback: LOW MANOEUVRES SPEED.

- Causes:**
1. Pump failure.
 2. Hydraulic oil level too low.



3. Oil filter clogged.

Remedies: 1. Replace the hydraulic pump.
1. Refill hydraulic oil.
2. Replace the filter.

If the problem persists, contact the Service.

Drawback: IMPOSSIBLE TO START THE ENDOTHERMIC ENGINE.

Causes: 1. Emergency button activated.
2. Battery discharged.
3. Out of fuel.
4. Hydraulic oil level too low.

Remedies: 1. Disable the emergency button.
2. Replace the battery.
3. Refuel.
4. Refill hydraulic oil.

If the problem persists, contact the Service.



Contact our Service Centre for any technical problem which is not identified nor solved by the aforesaid procedure.



10 ▶▶ Sealing list ◀◀

For your information, hereby there is a list of the anti-tampering sealings present on the MEWP:

- proportional valves;
- valves in filters distributor;
- red moment limiter valve on the turret;
- MEWP/stabilizers exchange solenoid valve;
- outriggers monitored electrovalve;
- yellow lever for emergency bypass;
- red cap of the lever for activation of emergency electropump.

 **The tampering or replacement of components by non-authorized staff is strictly forbidden.**

→ It is mandatory to restore the sealings after use of these items.



11 ▶▶ Overload tests ◀◀



During the commissioning of the machine, in the final test, we carried out the following overload tests. During the same, we tested S19HD stability and structural resistance.



Overload tests shall be carried out only on the first test of the machine: these tests are unique. In no other occasion shall you carry out tests with the same loads used in the overload tests.

Overload						
Test Nr.	Load in basket (Kg)	Booms position			Movement	Notes
		Radius (m)	Pantograph	Boom		
1	200 (PN) + 120 (CP)	7.60	completely lifted	horizontal	left/right side	OK
2	220 (PN) + 150 (CP)	7.60	Completely lifted	horizontal	left/right side	OK

NOTES.

PN: nominal payload.

CP: test load.



12 ▶▶ Operating tests ◀◀



During the commissioning of the machine, we carried out the following final operating tests. We have tested the correct operation of the S19HD and of its safety systems.

Test description	Outcome
▪ Block of the manoeuvre in case of release of the operation lever selected.	OK
▪ Basket levelling only allowed when the aerial part of the MEWP is in rest position (pantograph and telescopic boom on its support).	OK
▪ Manual pump for recovery manoeuvres in case of emergency.	OK
▪ Outriggers-boom operation interlock.	OK
▪ Block of the manoeuvres of the aerial part of the MEWP when this is not stabilized.	OK
▪ Block of stabilizers return/extraction when the aerial part is not in rest position.	OK
▪ Warning light for machine stabilized.	OK
▪ Warning light for electrical supply of the MEWP.	OK
▪ Warning light for aerial part use consent.	OK
▪ Emergency buttons in the control stations.	OK
▪ Lock valves on the cylinders.	OK
▪ Pressure relief valve for the protection of the entire hydraulic circuit.	OK
▪ Pressure relief valves for the protection of the individual parts of the system.	OK
▪ Fuse for the protection of the electrical system.	OK
▪ Moment limiting device	OK
▪ Load limiting device	OK



13 ▶▶ Control register ◀◀

This register is used to record the following events that concern the life of the machine:

- Delivery of the MEWP to the first owner (par. 13.1)
- Further transfers of ownership (par. 13.2)
- Replacement of mechanisms (par. 13.3)
- Replacement of structural elements (par. 13.4)
- Replacement of hydraulic components (par. 13.5)
- Replacement of electrical components (par. 13.6)
- Replacement of safety devices (par. 13.7)
- Considerable failures and relevant repairs (par. 13.8)
- Periodical inspections and maintenance journal (par. 13.9)
- Notes (par. 13.10)

13.1 ▶ Delivery of the MEWP to the first owner ◀

cmc[®]
AERIAL PLATFORM S

The mobile elevating work platform
brand **C.M.C.**
model **S19HD (PRO)**
serial number **S19A2140**
manufacture year **2020**

has been delivered by **C.M.C. s.r.l.**

to the firm
Duma Rent BVBA
Torkonjestraat 23 8510 Marke Belgium

according to the contractual conditions
established with the technical, dimensional and
functional features indicated in the
use and maintenance manual.

Date 31.01.2020

C.M.C. s.r.l.



13.2 ► Further transfers of ownership ◀

In this day.....the property of the MEWP in question is transferred to the company/society.....

This is to certify that, at the date mentioned above, the technical, dimensional and functional characteristics of the MEWP concerned are conform to those provided in origin and that any variation has been listed on this log.

The Seller

The Buyer

In this day.....the property of the MEWP in question is transferred to the company/society.....

This is to certify that, at the date mentioned above, the technical, dimensional and functional characteristics of the MEWP concerned are conform to those provided in origin and that any variation has been listed on this log.

The Seller

The Buyer

In this day.....the property of the MEWP in question is transferred to the company/society.....

This is to certify that, at the date mentioned above, the technical, dimensional and functional characteristics of the MEWP concerned are conform to those provided in origin and that any variation has been listed on this log.

The Seller

The Buyer

In this day.....the property of the MEWP in question is transferred to the company/society.....

This is to certify that, at the date mentioned above, the technical, dimensional and functional characteristics of the MEWP concerned are conform to those provided in origin and that any variation has been listed on this log.

The Seller

The Buyer



13.3 ▶ Replacement of mechanisms ◀

Description of the element.....
 Manufacturer.....
 Supplied by.....
 Cause of the replacement.....

 Place..... Date.....
 Stamp and signature person in charge The user

Description of the element.....
 Manufacturer.....
 Supplied by.....
 Cause of the replacement.....

 Place..... Date.....
 Stamp and signature person in charge The user

Description of the element.....
 Manufacturer.....
 Supplied by.....
 Cause of the replacement.....

 Place..... Date.....
 Stamp and signature person in charge The user

Description of the element.....
 Manufacturer.....
 Supplied by.....
 Cause of the replacement.....

 Place..... Date.....
 Stamp and signature person in charge The user



13.4 ▶ Replacement of structural elements ◀

Description of the element.....

Manufacturer.....

Supplied by.....

Cause of the replacement.....

.....

Place..... Date.....

Stamp and signature person in charge The user

Description of the element.....

Manufacturer.....

Supplied by.....

Cause of the replacement.....

.....

Place..... Date.....

Stamp and signature person in charge The user

Description of the element.....

Manufacturer.....

Supplied by.....

Cause of the replacement.....

.....

Place..... Date.....

Stamp and signature person in charge The user

Description of the element.....

Manufacturer.....

Supplied by.....

Cause of the replacement.....

.....

Place..... Date.....

Stamp and signature person in charge The user



13.5 ▶ Replacement of hydraulic components ◀

Description of the element.....
 Manufacturer.....
 Supplied by.....
 Cause of the replacement.....

 Place..... Date.....
 Stamp and signature person in charge The user

Description of the element.....
 Manufacturer.....
 Supplied by.....
 Cause of the replacement.....

 Place..... Date.....
 Stamp and signature person in charge The user

Description of the element.....
 Manufacturer.....
 Supplied by.....
 Cause of the replacement.....

 Place..... Date.....
 Stamp and signature person in charge The user

Description of the element.....
 Manufacturer.....
 Supplied by.....
 Cause of the replacement.....

 Place..... Date.....
 Stamp and signature person in charge The user



13.6 ▶ Replacement of electrical components ◀

Description of the element.....
Manufacturer.....
Supplied by.....
Cause of the replacement.....
.....
Place..... Date.....
Stamp and signature person in charge The user

Description of the element.....
Manufacturer.....
Supplied by.....
Cause of the replacement.....
.....
Place..... Date.....
Stamp and signature person in charge The user

Description of the element.....
Manufacturer.....
Supplied by.....
Cause of the replacement.....
.....
Place..... Date.....
Stamp and signature person in charge The user

Description of the element.....
Manufacturer.....
Supplied by.....
Cause of the replacement.....
.....
Place..... Date.....
Stamp and signature person in charge The user



13.7 ▶ Replacement of safety devices ◀

Description of the element.....

Manufacturer.....

Supplied by.....

Cause of the replacement.....

.....

Place..... Date.....

Stamp and signature person in charge The user

Description of the element.....

Manufacturer.....

Supplied by.....

Cause of the replacement.....

.....

Place..... Date.....

Stamp and signature person in charge The user

Description of the element.....

Manufacturer.....

Supplied by.....

Cause of the replacement.....

.....

Place..... Date.....

Stamp and signature person in charge The user

Description of the element.....

Manufacturer.....

Supplied by.....

Cause of the replacement.....

.....

Place..... Date.....

Stamp and signature person in charge The user



13.8 ▶ Considerable failures and relevant repairs ◀

Description of the failure.....

.....
.....

Causes.....

.....
.....

Repair activity.....

.....
.....

Place..... Date.....

Stamp and signature person in charge The user

Description of the failure.....

.....
.....

Causes.....

.....
.....

Repair activity.....

.....
.....

Place..... Date.....

Stamp and signature person in charge The user



13.9 ▶ Periodical inspections and maintenance journal ◀

➔ The user has the obligation to respect the maintenance program described in this manual and register the inspections in a proper journal.

DATE	DESCRIPTION OF THE OPERATION	SIGNATURE

DATE	DESCRIPTION OF THE OPERATION	SIGNATURE



DATE	DESCRIPTION OF THE OPERATION	SIGNATURE	DATE	DESCRIPTION OF THE OPERATION	SIGNATURE



13.10 ▶ Notes ◀

.....

.....

.....

.....

.....

.....

.....

.....

.....

.....

.....

.....

.....

.....

.....

.....

.....

.....

.....

.....

.....

.....

.....

.....

.....

.....

.....

.....

.....

.....

.....

.....

.....

.....

.....

.....

.....

.....

.....

.....

.....

.....

.....

.....



▶▶ Index ◀◀

- 0 ▶▶ Introduction ◀◀ 1
 - 0.1 ▶ Content of the manual ◀ 1
 - 0.2 ▶ Disclaimer ◀ 2
 - 0.3 ▶ Where and how to keep the manual ◀ 2
 - 0.4 ▶ Regulatory references ◀ 2
 - 0.5 ▶ Amendments and integrations ◀ 3
- 1 ▶▶ Specifications ◀◀ 4
 - 1.1 ▶ Technical sheet ◀ 4
 - 1.2 ▶ Identification plate ◀ 6
 - 1.3 ▶ CE certification ◀ 7
 - 1.4 ▶ TÜV certification ◀ 7
 - 1.5 ▶ Classification ◀ 7
 - 1.6 ▶ Loading cycles ◀ 7
 - 1.7 ▶ Working diagram and stabilization areas ◀ 8
- 2 ▶▶ Description and purpose ◀◀ 9
 - 2.1 ▶ Definition ◀ 9
 - 2.2 ▶ Machine purpose ◀ 9
 - 2.3 ▶ Description of the main components ◀ 9
- 3 ▶▶ Control positions ◀◀ 11
 - 3.1 ▶ Engines ignition station ◀ 11
 - 3.2 ▶ Platform control stations ◀ 14
 - 3.3 ▶ Emergency control stations ◀ 20
- 4 ▶▶ Use procedures ◀◀ 22
 - 4.1 ▶ Environmental operating conditions ◀ 22
 - 4.2 ▶ Safety distances ◀ 23
 - 4.3 ▶ Transport, storage and packaging ◀ 23
 - 4.4 ▶ MEWP use procedures ◀ 26
 - 4.5 ▶ Lithium battery pack recharge (*optional) ◀ 31
 - 4.6 ▶ Emergency manoeuvres ◀ 32
 - 4.7 ▶ Safety rules ◀ 38
 - 4.8 ▶ Safety devices ◀ 41
- 5 ▶▶ Markings ◀◀ 43
- 6 ▶▶ Electrical system ◀◀ 56
- 7 ▶▶ Hydraulic system ◀◀ 57
- 8 ▶▶ Maintenance ◀◀ 58
 - 8.1 ▶ Daily maintenance ◀ 58
 - 8.2 ▶ Weekly maintenance (or every 40 hours) ◀ 60
 - 8.3 ▶ Monthly maintenance (or every 120 hours) ◀ 60
 - 8.4 ▶ Quarterly maintenance (or every 300 hours) ◀ 61
 - 8.5 ▶ Maintenance after the first 400 hours ◀ 61
 - 8.6 ▶ Semi-annual maintenance (or every 750 hours) ◀ 61
 - 8.7 ▶ Annual Maintenance (or every 1500 hours) ◀ 61
 - 8.8 ▶ Biannual maintenance ◀ 61
 - 8.9 ▶ Five-year maintenance ◀ 61
 - 8.10 ▶ Safety rules during maintenance ◀ 61
 - 8.11 ▶ Maintenance of endothermic engine ◀ 62
 - 8.12 ▶ Maintenance of 48 V electric engine (*optional) ◀ 63
 - 8.13 ▶ Consumables ◀ 63
 - 8.14 ▶ Indications for the dismantling of the MEWP ◀ 64
 - 8.15 ▶ Service ◀ 64
- 9 ▶▶ Troubleshooting ◀◀ 67
- 10 ▶▶ Sealing list ◀◀ 69
- 11 ▶▶ Overload tests ◀◀ 70
- 12 ▶▶ Operating tests ◀◀ 71
- 13 ▶▶ Control register ◀◀ 72
 - 13.1 ▶ Delivery of the MEWP to the first owner ◀ 72
 - 13.2 ▶ Further transfers of ownership ◀ 73
 - 13.3 ▶ Replacement of mechanisms ◀ 74
 - 13.4 ▶ Replacement of structural elements ◀ 75
 - 13.5 ▶ Replacement of hydraulic components ◀ 76
 - 13.6 ▶ Replacement of electrical components ◀ 77
 - 13.7 ▶ Replacement of safety devices ◀ 78
 - 13.8 ▶ Considerable failures and relevant repairs ◀ 79
 - 13.9 ▶ Periodical inspections and maintenance journal ◀ 80
 - 13.10 ▶ Notes ◀ 82