



*Use and maintenance manual*  
**MAN.243 Rev.0**



**ORIGINAL**

# **CMC S28**

*Mobile elevating work platform*

**Brand C.M.C.**

**Model S28**



## 0 ▶▶ Introduction ◀◀

**T**hank you for the trust you have showed us buying a C.M.C. mobile elevating work platform (MEWP). We are sure you will be pleased with your choice.







### 0.1 ▶ Content of the manual ◀

This manual contains the technical specifications and the instructions for transfer, use and maintenance of the MEWP. While drawing up this manual, we took into consideration all the operations that are part of a normal use and a regular maintenance of the machine. So, for a correct and optimum use, you must follow the described instructions carefully.

This manual has been drawn up in order to:

- ❑ Show the technical features of the machine;
- ❑ Describe the control stations and their commands;
- ❑ Provide with the instructions for the transport, placement and use of the machine;
- ❑ Describe the safety devices;
- ❑ Point out the potential risks and/or possible dangerous situations;
- ❑ Provide with the necessary instructions for the ordinary maintenance operations;
- ❑ Provide with the instructions for the filling of the check register.

**📖 THE USE AND MAINTENANCE MANUAL IS CONSIDERABLE AS A PART OF THE MACHINE.** In case of sale of the MEWP, please give this manual to the new owner.

	<b>(CAUTION)</b>	= it warns the user about the risk of serious damages to people or to part of the equipment or the vehicle, if you do not obey the safety regulations.
	<b>(WARNING)</b>	= it notifies the possibility of minor injuries to people or little damages to the platform or vehicle parts.
	<b>(FORBIDDEN)</b>	= prohibition signal.
	<b>(OBLIGATION)</b>	= obligation signal.
	<b>(CAUTION)</b>	= it warns the user about the risk of environmental pollution.
*	<b>(OPTIONAL)</b>	= it indicates an optional outfit.
	<b>(IMPORTANT NOTE)</b>	= indicates information and suggestions useful to work with the MEWP.

- ➔ This manual is addressed to:
- **users:** operators, ground assistants, guard staff, safety manager, service manager;
  - **manufacturers, dealers, owners, lessors or lessee, brokers.**

#### LEGEND OF SYMBOLS USED IN THIS MANUAL:





## 0.2 ▶ Disclaimer ◀

C.M.C. declines all responsibility in case of partial or total non-observance of the following instructions

- ➔ Before any operation with the machine, the user is obliged to read carefully the text of this manual, with reference to sections relative to specific work activity to perform.
- ➔ The use of the machine must be entrusted only to trained and authorized staff. This manual cannot replace in any way a suitable experience that the staff in charge must have gained previously on similar machines or that they will be able to get on this machine, under the guidance of an already trained staff.
- ➔ The user must work within the functional limits of the machine and perform a constant and diligent maintenance, using only original spare parts indicated by C.M.C.
- ➔ The operator shall carefully know the safety standards foreseen by national and international legislations and apply them during all operations with the MEWP.

☞ **The guarantee of proper functioning and full compliance of the machine with the intended service is strictly dependent on the correct application of all the instructions contained in this manual.**

☞ **The non-compliance with the previous items automatically invalidates the warranty.**

## 0.3 ▶ Where and how to store the manual ◀

- ➔ **The manual must be stored and kept in the best possible condition (away from sunlight), in a suitable place, for the purpose of always being available for consultation.**
- ➔ **This manual (or its copy) must always be on the machine** (in a case near the turret) for an immediate consultation by the operator during working operations.

- ➔ **Another copy shall be held by the basket operator during the working period inside the internal documents case.**
- ➔ **In case of loss or deterioration, the replacement documentation must be requested to C.M.C. s.r.l, citing the code of this manual.**

## 0.4 ▶ Legislative references ◀



**This manual has been drawn up according to the following national and international laws and directives:**

Directive 2006/42/CE	EN 280:2015	EN 13001-3-1
Directive 2014/35/UE	Directive 2000/14/CE	EN ISO 12100
ISO 13849-1-2	ISO 3864	EN 60068-2-64
ISO 13850	ISO 4302	EN 60204-1
ISO 13854	ISO 4305	EN 60204-32
ANSI/SAIA A92.20-2020	ANSI/SAIA A92.24-2018	IEC 60529
ANSI/SAIA A92.22-2020	ANSI Z359.1	EN 62061
CAN/CSA B354.6 (2017)	CAN/CSA B354.7 (2017)	ISO 13857
AS/NZS 1418.10-2011	AS NZS 1418.10-2011_A1-2017	ISO 20381



## 0.5 ▶ Changes and integrations ◀

The information and legislative references present in this manual are those in force when the machine has been placed on the market.

Due to the constant and continuous improvement of their product by the manufacturers, the supplied machine could present some technical specifications different from those described on this manual. Any change will be however accompanied with specific documents attached explaining functional characteristics. In case of differences in comparison with the basic contents of this manual, the user is kindly asked to contact C.M.C. to receive supplementary technical specifications.

As this manual includes both current and optional components, you could find information not applicable to your machine.

C.M.C. reserves the right to update its production and its instruction manuals (without prior notice) according to the development of the technique, to the acquisition of new experiences and/or the change of law provisions, without being anyway obliged to intervene on the previously sold machines and on their manuals.

No part of this publication can be translated, modified or reproduced (even partially) without the expressed authorization of C.M.C. s.r.l.

C.M.C. reserves the right to modify - totally or partially - any data or specification of this publication (without prior notice).

Data and references indicated in this manual are those in force at the time of printing.

Year 2020  
**C.M.C. s.r.l.**



# 1 ►► Specifications ◀◀

## 1.1 ► Technical sheet ◀

### PERFORMANCE

Max. working height	27,90 m	91.54 ft
Min. working height	-6,70 m	21.98 ft
Max. working outreach (with 80 kg)	14,00 m	45.93 ft
Max. working outreach (with 230 kg)	11,50 m	37.73 ft
Max. load on the basket	230 kg	507 lb
Jib movement	90°	
Turret rotation	+/-200° (tot. 400° continuous)	
Basket rotation	+/-90°	
Max. slope to stabilize	32° / 62%	
Max. ramp attack slope with crawlers widened (front/rear)	13°-17° / 23%-31%	
Max. ramp attack slope with crawlers closed (front/rear)	7°-10° / 12%-18%	
Max. slope to travel	19° / 34%	
Travel speed	0,5 - 2,4 km/h	0.3 - 1.5 mph

### DIMENSIONS

Basket height	1,10 m	3.61 ft
Basket width	0,70/0,60 m	2.30/1.97 ft
Basket length	1,70/1,20/0,80 m	5.58/3.94/2.62 ft
Total length with basket	6,80 m	22.31 ft
Length without basket	6,10 m	20.01 ft
Height in driving position (with crawlers closed/widened)	1,99/2,19 m	6.54/7.19 ft
Total width (without basket)	0,90 m	2.95 ft
Clearance from the ground in transport configuration (with crawlers closed/widened)	0,17/0,32 m	0.56/1.05 ft

Clearance under crawlers with machine stabilized	1,05 m	3.44 ft
Tracks (L x w)	1,75 x 0,25 m	5.74 x 0.82 ft
Width tracks adjustment	0,89/1,40 m	2.92 / 4.59 ft
Height tracks adjustment	0,18/0,33 m	0.59/1.08 ft
Max. longitudinal stabilization	6,67 m	21.88 ft
Max. cross stabilization	4,43 m	14.53 ft
Min. longitudinal stabilization	5,22 m	17.13 ft
Min. cross stabilization	2,67 m	8.76 ft
Intermediate stabilization	3,63 m	11.91 ft
Outriggers plate Ø	0,24 m	0.79 ft

### WEIGHT AND PRESSURES

Total weight (standard equipment)	4123 kg	9091 lb
<b>(R)</b> Max. pressure on the foot	5,84 kg/cm <sup>2</sup> (57,23 N/cm <sup>2</sup> )	83.06 lb/in <sup>2</sup>
<b>(S)</b> Max. pressure on the track	0,28 kg/cm <sup>2</sup> (2,72 N/cm <sup>2</sup> )	3.98 lb/in <sup>2</sup>
<b>(T)</b> Max. pressure in travel	772 kg/m <sup>2</sup> (7,57 KN/m <sup>2</sup> )	158 lb/ft <sup>2</sup>
<b>(U)</b> Max. pressure in work (4 feet opened)	146 kg/m <sup>2</sup> (1,43 KN/m <sup>2</sup> )	29.90 lb/ft <sup>2</sup>
<b>(V)</b> Max. pressure in work (4 feet closed)	213 kg/m <sup>2</sup> (2,09 KN/m <sup>2</sup> )	43.63 lb/ft <sup>2</sup>
<b>(Z)</b> Max. pressure in work (2 feet closed + 2 feet opened)	172 kg/m <sup>2</sup> (1,69 KN/m <sup>2</sup> )	35.23 lb/ft <sup>2</sup>

### POWER

Standard hydraulic feed	1) Kubota D902-E4B diesel, 16.1 kW (21.6 HP), 3200 rpm
*Optional feeds	2) Electric engine 230/110/120 V 380/230/240-460 V 3) Motor G0901306, 9 kW, 48 V, with lithium batteries 200 Ah 4) Hybrid motor (diesel + lithium batteries)
Fuel tank capacity	30 l



Max values (speed/force) allowed according to USA/EU standards	
Max allowed lifting and descending speed of the MEWP	0,4 m/s (1.31 ft/s)
Max allowed boom extension and withdrawal speed	0,4 m/s (1.31 ft/s)
Max allowed rotation speed	0,7 m/s (2.3 ft/s)
Max allowed manual force in the basket with 1 operator	400 N



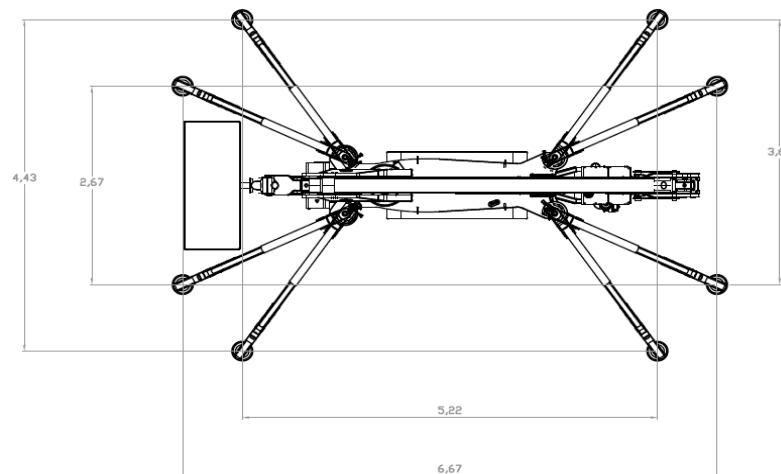
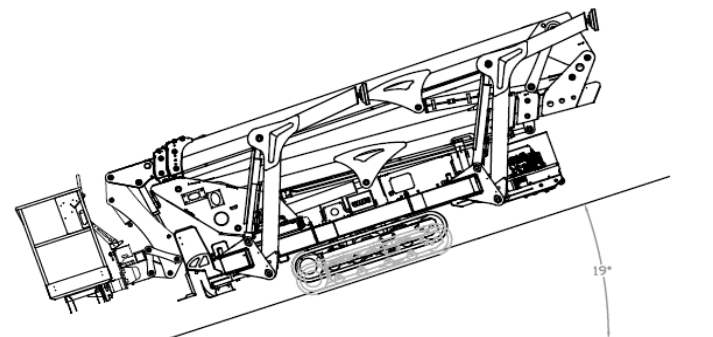
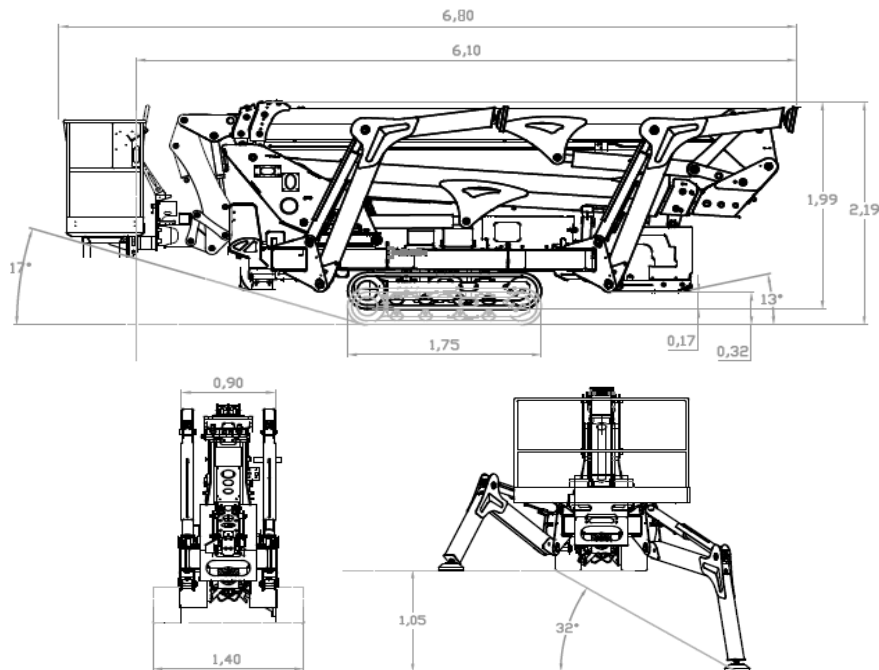

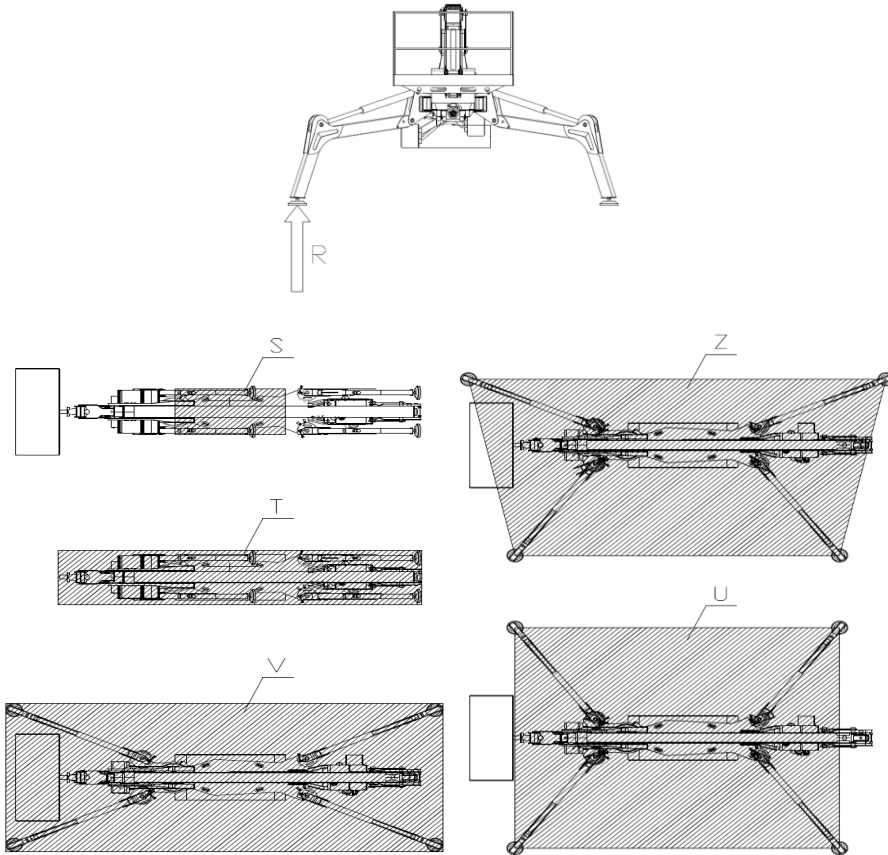
		Tightening torque
<b>Bolts of the bearing</b>	M16 cl 10.9	28 daNm





## 1.2 ► Identification plate

On the turret, there is a plate with (engraved) all the MEWP identification data:

   			
TYPE	S28	MANUFACTURER	C.M.C.
MODEL	S28	YEAR	2020
SERIAL NR.		TOT. WEIGHT	
CAPACITY	230 kg	INCLUDING	2 persons
MAX HYDRAULIC OPERATING PRESSURE	3336 PSI		
MAX MANUAL HORIZONTAL FORCE ALLOWED	40 daN		
MAX WIND SPEED ALLOWED	12,5 m/s		
MAX FRAME INCLINATION ALLOWED	1°		
EXTERNAL POWER SOURCE	230 V	50 Hz	

Picture 1: identification plate.



### 1.3 ▶ CE certification ◀

C.M.C. s.r.l. states under its own responsibility that **S28** was designed and produced in compliance with national and European standards, and that the machine is identical to the model submitted to control and test for the “CE certification” by the Notified Institute **nr. 1878 - VERICERT s.r.l. - via L. Masotti, 5 - 48124 Fornace Zarattini (RA) - Italy.**

A copy of the CE Certificate is attached to the manual.

### 1.4 ▶ TÜV certification ◀

C.M.C. s.r.l. states under its own responsibility that **S28** was designed and produced in compliance with US standards ANSI/SAIA A92.20:2018 and that the machine is identical to the model submitted to control and test for the “TÜV certification” by **TÜV SÜD America Inc.**

TÜV SUD America Inc. is an OSHA recognized NRTL and a Standards Council of Canada accredited certification body.

### 1.5 ▶ Classification ◀

The mobile elevating work platform (MEWP) **S28** belongs to **group B**: the vertical projection of the area center of the MEWP in different platform configurations specified by the manufacturer can be outside the tipping lines (EN 280 par. 1.4 - ANSI/SAIA A92.20 par. 3).

As for the displacement, it belongs to **type 1**: travelling is only allowed with the MEWP in its transport configuration or in the stowed position (EN 280 par. 1.4 - ANSI/SAIA A92.20 par. 3).

### 1.6 ▶ Loading cycles ◀

The machine is expected to last for 40.000 loading cycles<sup>1</sup> (i.e. 10 years, for 40 weeks per year, for 20 hours per week, for 5 loading cycles per hour).

**Within this term of time, the machine must undergo at least 2 (two) deep checks** (structural, mechanical, electric, elements, etc.), **in case of particularly heavy uses** (frequent use at the performance limit, particularly unfavorable environmental conditions such as steel plants, paper mills and so on) **it is better to increase checks.** Anyway, **it is a good rule to have the state of the machine checked by the manufacturer factory or by an authorized workshop, at least every 1500 - 2000 hours of work or once per year.**

<sup>1</sup>Loading cycle: a cycle starts from the access position, continues performing the work and finishes returning to the access position.



1.7 Working diagram

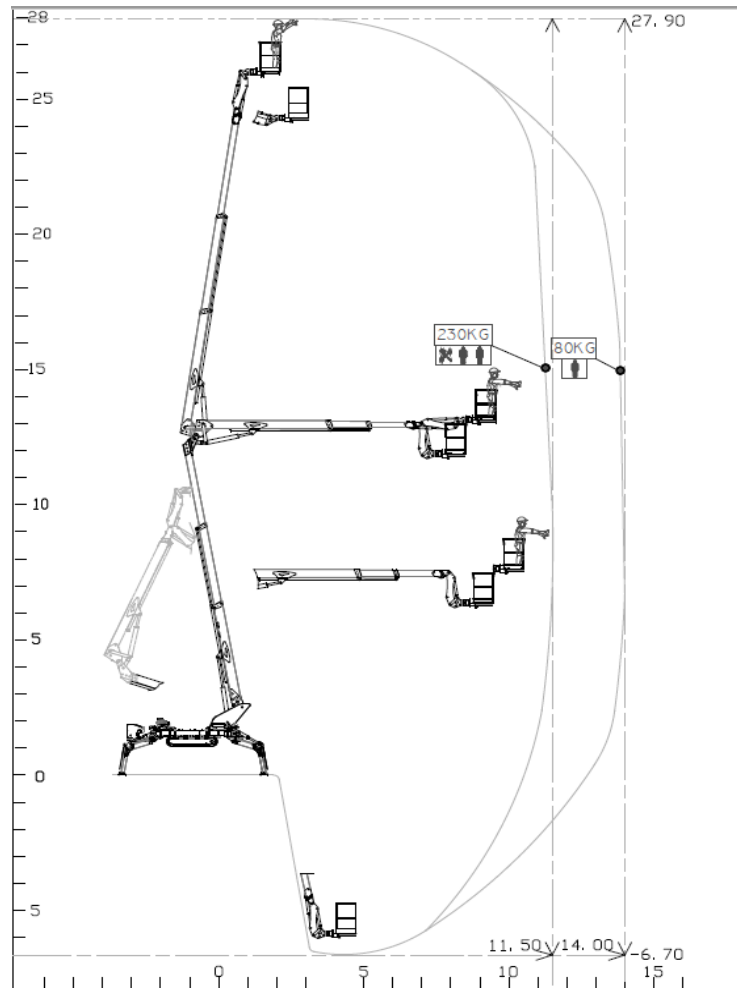

Picture 2a: work diagram  
(valid only in the working area set by the outriggers placement).

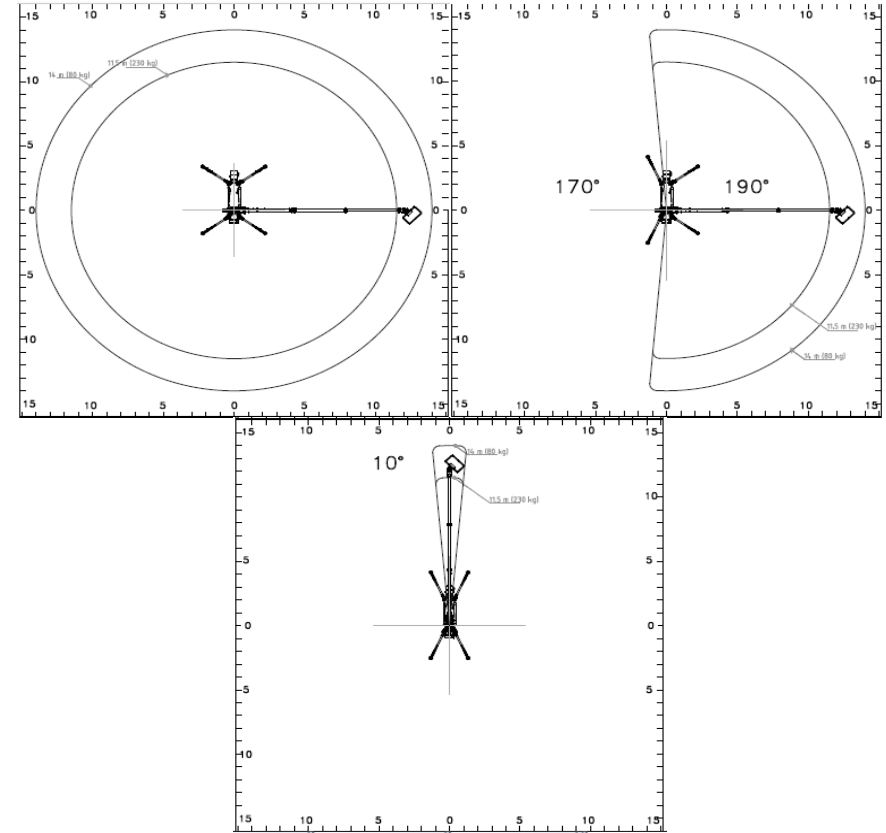

Picture 2b: work areas.



## 2 ▶▶ Description and purpose ◀◀

### 2.1 ▶ Machine definition ◀

**The machine is called S28 and it is a mobile elevating work platform (MEWP):**

- machine/device intended for moving persons, tools and material to working positions, consisting of at least a work platform with controls, an extending structure and a chassis (ANSI/SAIA 92.20 par. 3);
- mobile machine intended to move persons to working positions, where they are carrying out work from the work platform, with the intention that persons are getting on and off the MEWP only at access positions at ground level or on the chassis and which consists as a minimum of a work platform with controls, an extending structure and a chassis (EN 280 par. 3.1).



**It is forbidden to use the MEWP with methods and/or conditions other than those specified and approved by the manufacturer.**

### 2.2 ▶ Machine purpose ◀

The MEWP **S28** is a machine which enables the operators to reach the working place when this is high positioned.

**The machine has been designed for an essentially vertical use. It must be travelled only when it is totally folded in the transport position.**

**➔ The use of the machine is allowed only to professional staff, properly trained and specialized.**

2.3 ▶ Description of the main components

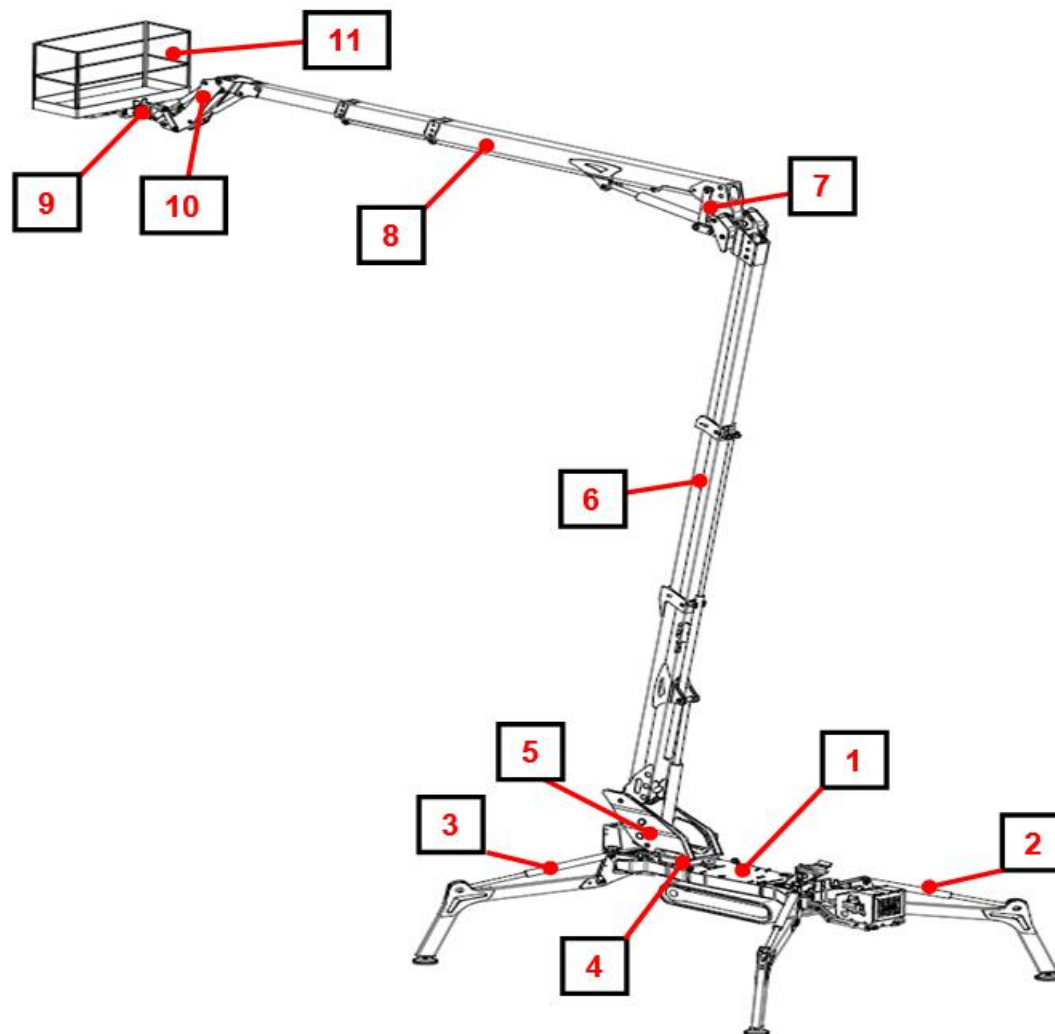

Picture 3: MEWP main components.



### 2.3.1 ▶ Frame

The frame **1** (Picture 3) is a structure in quality steel, able to equally divide the equipment's weight when the MEWP is in transport position. The frame has 4 oil-pressure jack beams for stabilization [2 front stabilizer cylinders 2 (Picture 3), 2 rear stabilizer cylinders 3 (Picture 3)]. The basis for the bearing is placed on the frame 4 (Picture 3). It enables the swinging of the equipment through the turn-table.

### 2.3.2 ▶ Turret

The turret **5** (Picture 3), in quality steel, is secured to the bushing (bearing). A hydraulic engine, with brake normally closed, constrained to the turret, allows the rotation of the superstructure.

### 2.3.3 ▶ First telescopic boom group

The first telescopic boom group **6** (Picture 3) is composed by three elements: a fixed boom and two extendable booms.

The extension (or withdrawal) of the telescopic boom is given by operating the "telescopic boom extension cylinder".

The movement of the boom (lifting and lowering) is given by the lifting hydraulic cylinder. Such cylinder is secured to the turret (cylinder side) and to the fixed boom (piston side) and is supplied with safety valves.

### 2.3.4 ▶ Second telescopic boom group

The second telescopic boom group **8** (Picture 3) is hinged to the first telescopic boom by a rod **7** (Picture 3). The telescopic boom is composed by three elements: one fixed boom hinged to the rod and two extendable booms.

The extension (or withdrawal) of the telescopic boom is given by operating the "telescopic boom extension cylinder".

The lifting (or lowering) of the telescopic boom is given by operating the "lifting cylinder of second telescopic boom group".

### 2.3.5 ▶ Jib

At the end of the second telescopic boom is hinged a boom named Jib **10** (Picture 3). The lifting or descent of the Jib is done by operating the "Jib lifting cylinder".

### 2.3.6 ▶ Basket

the basket **11** (Picture 3) is in aluminum tubulars and has a lateral opening to allow the entrance of the operators. The lateral opening is automatically shuttered and built to avoid accidental openings. The basket has attacks for safety belts, a guardrail 1,1 m high from the basket floor, an intermediate guardrail and a foot protecting band along all sides of the platform. The floor is in antiskid and auto-draining aluminum. The basket is connected to a support **9** (Picture 3) through which it is coupled with the jib.

## 3 ▶▶ Control stations ◀◀

### 3.1 ▶ Machine switching on/off station ◀

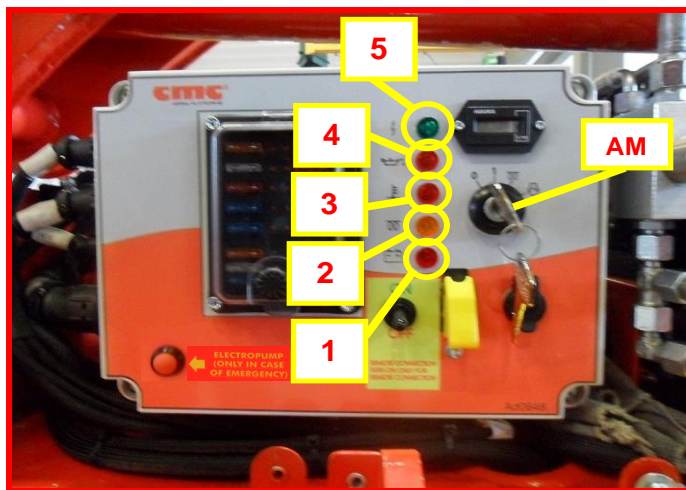



Picture 4: engine switch on/off station.

In this station (Picture 4) allocated on the right side of the frame, you can see:

- the **AM** key: through it, it is possible to turn on the electric system and start the endothermic engine;
- the green light **5** indicating system power supply: it is on when the AM key is in position 1;
- the red light **4** which signals low pressure to the engine oil;
- the red light **3** which monitors coolant level;
- the orange light **2** indicating the spark plugs working;
- the red light **1** which signals an alternator failure;
- the hour counter.

#### 3.1.1 ▶ Ignition of the endothermic engine

In order to start the endothermic engine, turn the key all the way to the right up to the symbol .

Before starting the engine, especially if the MEWP is used in workplaces with low atmospheric temperatures, it is advisable to heat the spark plugs of the machine motor while keeping the key on the symbol  for a few seconds: this will cause the corresponding orange light **2** (Picture 4) to turn on.



Picture 5: heating phase of the engine spark plugs.

The ignition of the endothermic engine can also be carried out with the help of the radio control or of the console in the basket.

Using the radio control:

- turn the key to position 1;
- connect the radio control (link procedure in par. 3.2.2),
- move the lever in the Picture upwards, present on the left side of the radio control under the joystick **J1** (Picture 7);
- in this case, the green light **5** (Picture 4) will light up both on the key station and on the radio control, to signal the correct power supply of the machine.

Otherwise, using the console in the basket (already wired to the machine):

- turn the key to position 1;
- press the endothermic engine start button **9** (Picture 11)
- also, in this case, the green light **5** (Picture 4) will light up both at the key station and on the console, to signal the correct power supply of the machine.



Picture 6: key position for ignition of endothermic engine from radio control or from basket console.



Picture 7: power on/off lever on the radio control.

To switch off the endothermic engine, you can alternatively:

- turn the key all the way to the left on position 0;

- lift the lever in Picture 7, if the radio control has been used;
- press the endothermic engine start/stop button **9** again (Picture 11), if you are at the control station in the basket;
- press, in emergency situations, one of the emergency buttons on the machine (par. 4.5.1).

### 3.1.2 ▶ Switching on/off the electric motor (\*optional)

If you choose to use the electric motor (\*optional):

- connect the 110/120/230 V socket (Picture 8) to the nearest electrical source;



Picture 8a: socket connection.

- from the radio control, start the engine by pushing the lever in Picture 7 downwards or alternatively from the console in the basket press the start button of the electric motor **10** (Picture 11);
- the power supply is signaled by the lighting up of the green led **5** both on the engine ignition station and on the control stations.



To switch off the electric motor, it will be enough to alternatively:

- turn the key all the way to the left on position 0;
- lower the lever mentioned above of the radio control;
- re-press the on/off button **10** on the console in the basket;
- press, in emergency situations, one of the emergency buttons provided on the machine (par. 4.5.1).

### 3.1.3 ▶ Other power supplies \*optional

The machine can be supplied on request completely with a 48 V electric motor powered by 200 Ah lithium batteries or with a hybrid feed.



**It is not possible to have the 48 V electric motor and the 110/120/230 V one activated on the machine at the same time.**



**It is not possible to turn on both the endothermic engine and the electric motor at the same time.**

The start and stop of the 48 V electric motor will be the same shown above for 110/120/230 V electric motor.

To recharge the batteries:

1. couple the socket (power line) to the plug on the machine and lift the button provided on the machine's thermal magnetic panel;
2. the batteries will be charging and, if the electric system is ON, the progress of the charging process will be shown on both the control station display and the appropriate leds of the box in the basket.



**When the state of batteries charge, during the use, reaches the lowest level (under 10%), all work maneuvers will be interrupted, and it will only be possible to close the machine again.**



**It is absolutely forbidden to direct high-pressure jets of water onto the support containing the battery pack. High water pressure**

**could generate serious and irreversible problems in the operation of the machine.**

As optional\*, a voltage selector can be mounted on the MEWP to supply a different electric power compared to that of the auxiliary electric engine provided, thanks to a transformer on the chassis.



Picture 8b: transformer box with voltage selector.

## 3.2 ▶ Platform control stations ◀

The main standard platform control station is:

- **AUTEC radio/wired remote control (Picture 13).**

The \*optional platform control stations are:

- **MOBA console (Picture 9) positioned on the basket;**
- **second AUTEC wired remote control positioned on the basket.**



**It is not possible to use two different control station at the same time.**

The system will select as actual control station the first one that will be used by the operator. Once the AUTECH radio control station is linked, it will become the actual control station, and in order to select a different control station you need to turn off and back on the system by the ignition key or any of the emergency buttons on the machine (except the one on AUTECH radio remote control).

### 3.2.1 ▶ Platform control station on the basket (\*optional)



Picture 9: platform control (exercise) station.

The platform MOBA (\*optional) control station (Picture 9) on the basket has:

- **two joysticks J1 and J2 (dead man commands)** for movement operations;
- **a red mushroom-shaped emergency button EB** (on the right side of the control station): it stops the machine de-energizing the electrical circuits;



The emergency button has an auto-detent mechanical locking system; therefore, it is necessary to unlock the button turning it clockwise to reset its operability.

- **a series of control buttons/lights** described in the following table.

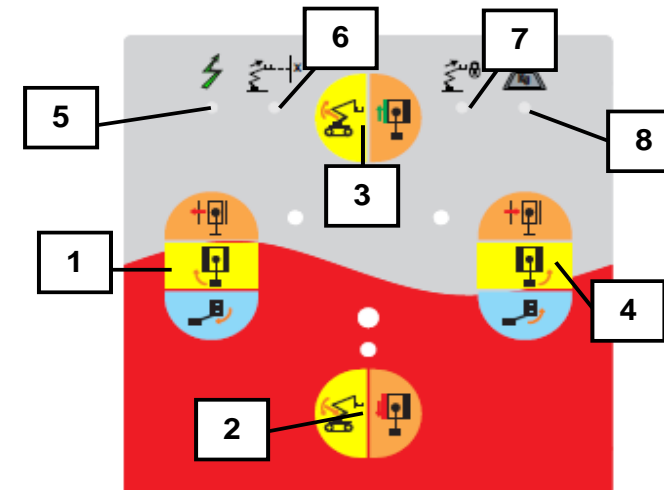

Picture 10: left side of basket console.



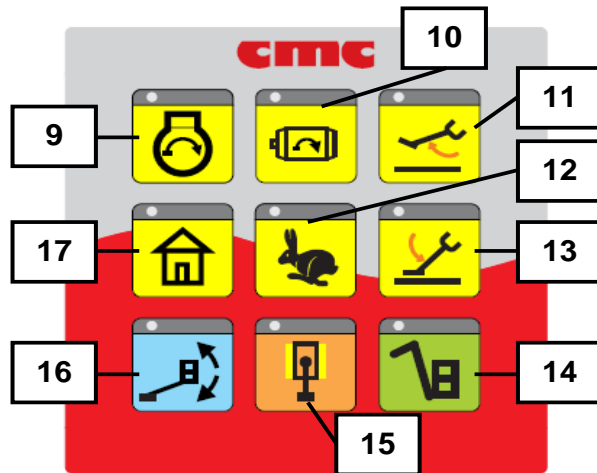

Picture 11: central side of basket console.

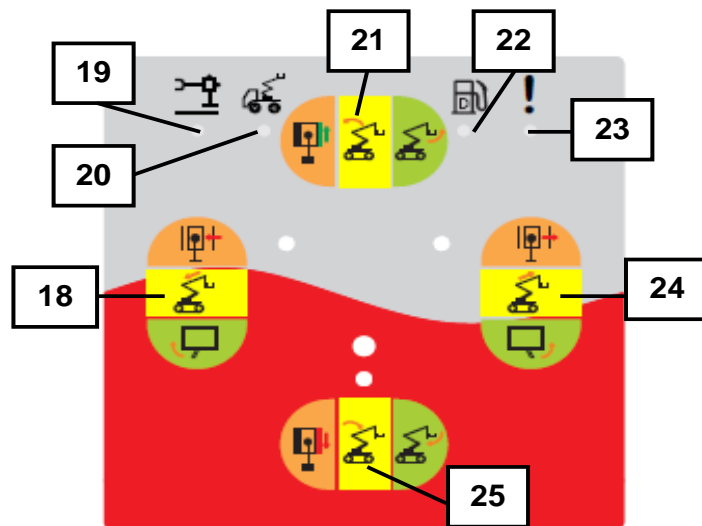

Picture 12: right side of basket console.

The basket control station (\*optional) allows the following maneuvers:

Button nr.	Operation description
1	Opening of the left track / clockwise rotation of turret / internal leveling of basket
2	Return and lowering of boom 1 / backward movement of the left track
3	Lifting and extension of boom 1 / forward movement of the left track
4	Closing of the left track / counterclockwise rotation of turret / external leveling of basket
5	MEWP power supply indicator
6	Pre-alarm light: maximum performance almost reached
7	Alarm light when reaching the maximum performance
8	Alarm light when reaching the load limit
9	Endothermic engine switching on/off button
10	Electric engine (*optional) switching on/off button
11	Automatic destabilization button from basket
12	Speed selection button among two predefined levels of increase: it has a flashing light in "hare" mode and a fixed one in "double hare" mode.
13	Automatic stabilization button from basket
14	Button for: 1. lifting/lowering jib 2. basket rotation
15	On/off tracks movement button
16	Deadman button for basket leveling operations, to be kept pressed during movement towards left/right of the joystick J1
17	"Home function" button

18	Closing of the right track / return of boom 2 / clockwise rotation of the basket
19	Stabilization consent light
20	Aerial part consent light
21	Forward movement of the right track / lifting of boom 2 / lifting of jib
22	Not used
23	Error/failure indicator light
24	Opening of the right track / extension of boom 2 / counterclockwise rotation of the basket
25	Backward movement of the right track / lowering of boom 2 / lowering of jib

### 3.2.2 ▶ Platform radio control station

The main standard radio control station AUTEC is activated only by carrying out the connection procedure described below (radio control activation directly excludes the basket control station).



Picture 13: platform radio control station.

#### Radio control link procedure:

1. To connect the radio control, press the green Start/Link button **SL** (Picture 14) down on the left side.



Picture 14: start/link button on radio control.

- If the radio control is not correctly connected to the machine, the message in Picture 15 will appear on the display; in addition, the green led on the underside of the display flashes intermittently and a buzzer on the electric box emits an intermittent acoustic signal.



Picture 15: no link message on radio control display.

- Press the Start/Link button again: when the connection is complete, the buzzer stops and the green led starts to light up at the rate of two flashes interspersed with a pause.

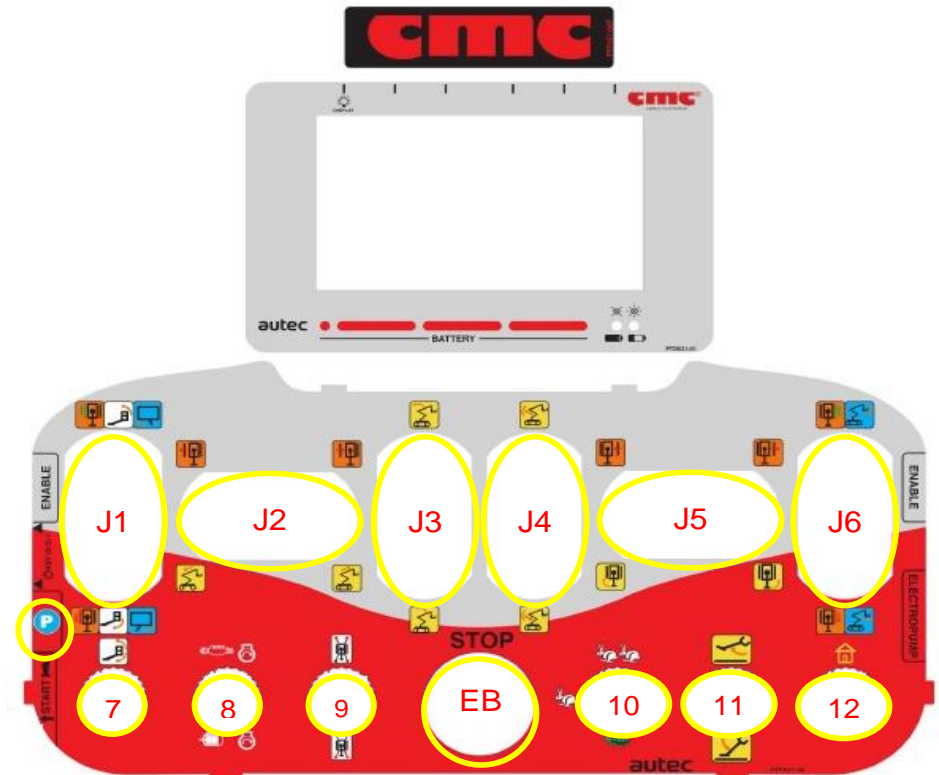

Picture 16: AUTEK radio control marking.

The AUTEK radio control has the following commands:

Command nr.	Operation description
EB	Red mushroom-shaped emergency button that stops the machine
J1	Forward or backward movement of the left track / internal or external leveling of the basket / clockwise or counterclockwise rotation of the basket



J2	Opening and closing of the left track / return and extension of boom 2
J3	Lifting and lowering of boom 2
J4	Return and lowering of boom 1 / lifting and extension of boom 1
J5	Opening and closing of the right track / clockwise or counterclockwise rotation of turret
J6	Forward or backward movement of the right track / lifting and lowering of jib
7	Deadman lever for basket leveling operations, to be kept shifted upward during movement towards up or down of the joystick J1
8	Switch on/off lever: upward for endothermic engine and downward for electric motor (*optional).
9	Roll-over control lever: upward to move front outriggers and downward to move rear outriggers.
10	Speed selector: from minimum "turtle" speed to maximum "double hare" speed.
11	Automatic stabilization/destabilization lever
12	"Home function" button
P	"Parking" button



The emergency button has an auto-detent mechanical locking system; therefore, it is necessary to unlock the button turning it clockwise to reset its operability.



The functions contained on the radio control are the same as those of the platform (exercise) control station in Picture 9 and they are indicated by the same symbols described above.

If the battery of the AUTEK radio control is low, it could become a wired remote control, by connecting the appropriate plug on its right side to the machine attack (Picture 17).



Picture 17: radio control connection.

A very important device of the radio control is the blue coding key **CK** on its left side (Picture 14), which puts the console in communication with the machine control unit. Be careful not to lose it.

### 3.2.2.1 ▶ AUTEK radio control display

Moreover, this station has a color display (Picture 18) which allows to visualize all the function parameters of the machine.



Picture 18: radio control display.



Picture 19: "Key Off" screen.

If the screen in Picture 19 appears, it means that the radio control is on, but the ignition key is in the OFF position. Then proceed with switching the ignition key in ON position (par. 3.1).

On the display, through the buttons at the top (Picture 18), it is possible to check and modify menu options and data.



Picture 20: Home screen.

Pressing the first key from the left H, at the top of the display, you access the "Home" screen (Picture 20).

In this screen, with the machine closed, the green consent led TRACKS is on for the use of the tracks during the machine travel.

Once the pins of each of the four outriggers have been inserted and a work area (1-narrow or 2-wide) has been selected for each outrigger, enabling the respective limit switch, stabilization consent green light STAB will also be displayed to use the outriggers.

Once the machine is correctly stabilized, the consent platform led PLATF will be on. As soon as one or more of outriggers will be on the ground, the tracks led will be off. On same screen, when the aerial part is not completely folded, also the stabilization consent light will be off.



Picture 21: Chassis screen.

Pressing the second key from the left C, you access the "Chassis" screen (Picture 21). In the C0 screen, a map of machine leds indicates the working areas A1-A2 selected for each stabilizer. As soon as stabilization is performed (par. 4.4.2), also the leds indicating the outriggers FR (front right) - FL (front left) - RR (rear right) - RL (rear left) will change from red to green; the consent light PLATF for use of the aerial part turn on, simultaneously with the turning off of the consent light TRACKS for use of tracks.



Picture 22: Chassis C1-C2 screens.

By pressing the down arrow key, the Chassis C1 and C2 screens (Picture 22) are displayed, highlighting the various system inputs:

- with the green leds on, the work areas in which the outriggers are open (ON GROUND NO - normally open on the ground);

- with the green leds off, the unused work areas where the outriggers are not open (ON GROUND NC - normally closed on the ground).
- emergency button of the outriggers control station;
- use of diesel engine;
- stabilizing pins inserted;
- use of electric motor;
- boom 1 resting on a support;
- monitored electro valve of the outriggers.

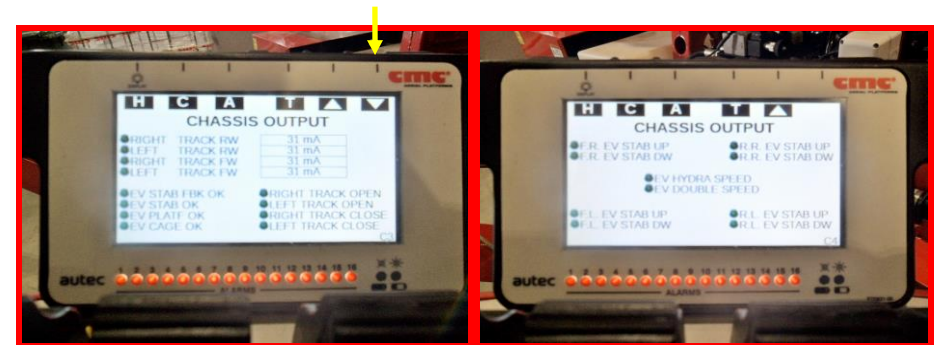

Picture 23: Chassis C3-C4 screens.

In the screens C3 and C4 (Picture 23), related to the "Chassis output", you can monitor:

- the current passages that lead to the track movements;
- the leds indicating the opening or closing of the tracks;
- the electro valves of outriggers, aerial part and basket;
- the electro valves that regulate the track speed.

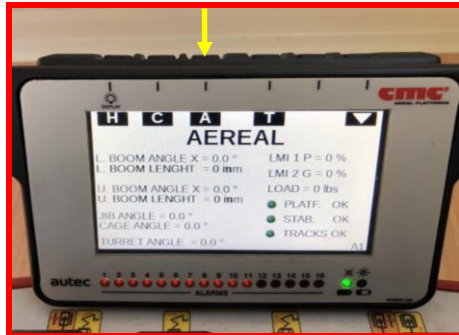

Picture 24: A1 screen.

By pressing the A key, you access the "Aerial Platform" screen (Picture 24), which allows you to view all the data concerning the aerial part of the machine.

In the A1 screen there are the values related to:

- length and angles of the booms;
- angles of jib, basket and turret;
- basket load;
- pressure and geometric limiters;
- consent leds for stabilization, use of tracks and aerial part.

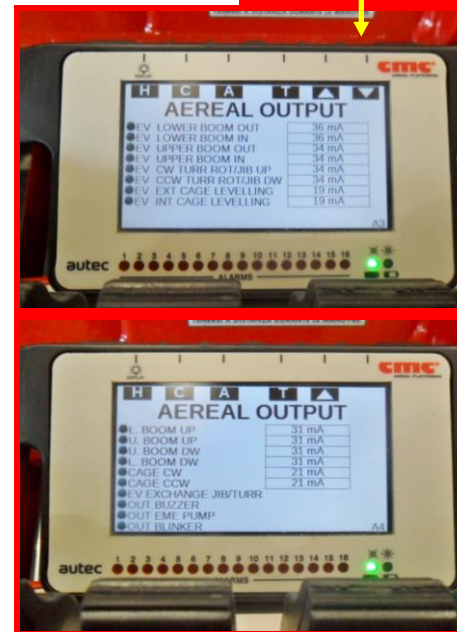
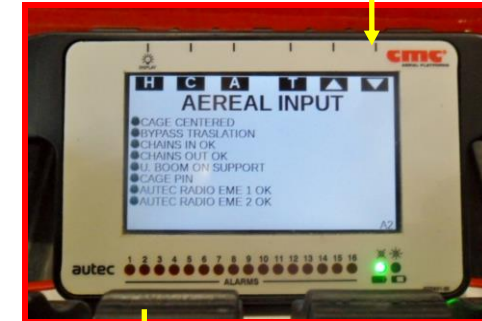

Picture 25: A2-A3-A4 screens.

In the A2, A3 and A4 screens (Picture 25), you can read the data in input and output of the system:

- centering of the basket;



- tracks lock bypass;
- chains of extension/retraction of booms;
- boom 2 resting on a support;
- pin inserted to fix the basket;
- activation of the radio control emergency button;
- values of electro valves for extension/retraction and lifting/lowering of booms, turret and jib rotation, rotation and leveling of the basket;
- turret/jib exchange electro valve;
- activation of acoustic signal, emergency electropump (\*optional), flashing light (\*optional).



Picture 26: T screen.

By pressing the T key (Picture 26), the display shows the hour meter (total and partial) and the errors list actually active on the machine.  
By long pressing the T key, the display shows the following screens:



Picture 27: T1-T14 screens.

In the screens from T1 to T14 (Picture 27), you can view a glossary of all errors that may appear on the display, with corresponding codes and descriptions.



Picture 28: T15 screen.

The T15 screen (Picture 28) allows checking the correct working (by turning on the relative green led) of all the buttons/levers of the radio control.  
Going down the screen, it is also possible to reset the total and partial hour counter.





Picture 29: T26 screen.

In the T26 screen (Picture 29), the display language can be selected.



Picture 30: T27-T28 screens.

In T27-T28 screens (Picture 30), the units of measurement for weights and lengths can be selected among European and US measurement systems.



Picture 31: password screen.

With this screen (Picture 31), it is possible to enter in a menu useful to modify all the sensor calibrations.

The password can be inserted only by the manufacturer C.M.C. or the authorized workshop staff.



The following operations must be made after C.M.C. authorization and under the supervision of trained and specialized staff.



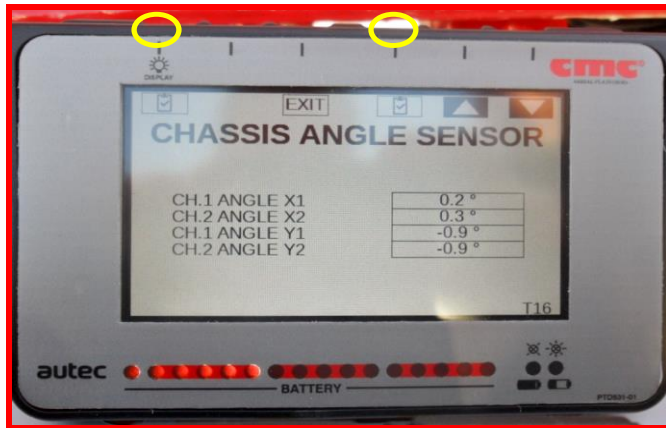

Picture 32: T16 screen.

In T16 screen (Picture 32), there are the values of chassis angle sensor and it is possible to reset the sensor calibration pressing simultaneously the first button and the fourth one from the left, placed on top.



Picture 33: T17 screen.

In T17 screen (Picture 33), there are the pressure transducers on low and high sides, and it is possible only to visualize their actual values measured.



Picture 34: T18 screen.

The T18 (Picture 34) screen shows the load cell values: also, in this case, the sensor calibration can be reset by pressing the same buttons abovementioned.

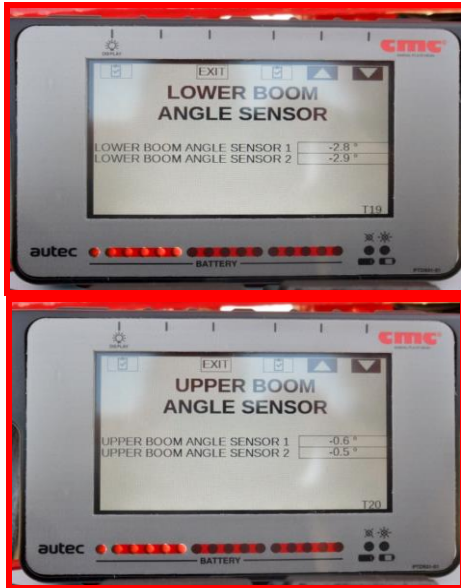

Picture 35: T19-T20 screens.

In T19-T20 screens (Picture 35), the values of the two lower boom angle sensors and the two upper boom angle sensors are visualized: their sensor calibration can be reset.



Picture 36: T21-T22 screens.

The T21-T22 (Picture 36) screens show the values of the two jib angle sensors and the two basket angle sensors: it is possible to reset the sensor calibration.



Picture 37: T23-T24 screens.



In T23-T24 screens (Picture 37), there are the values of the two lower boom length sensors and the two upper boom length sensors: their sensor calibration can be reset.

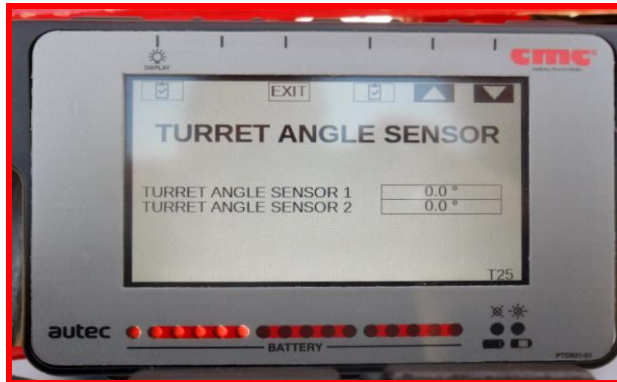

Picture 38: T25 screen.

In the final T25 screen (Picture 38), it could be visualized the values of the two turret angle sensors: their sensor calibration can be reset, too.

### 3.3 ▶ Emergency control stations ◀

#### 3.3.1 ▶ Outriggers control station

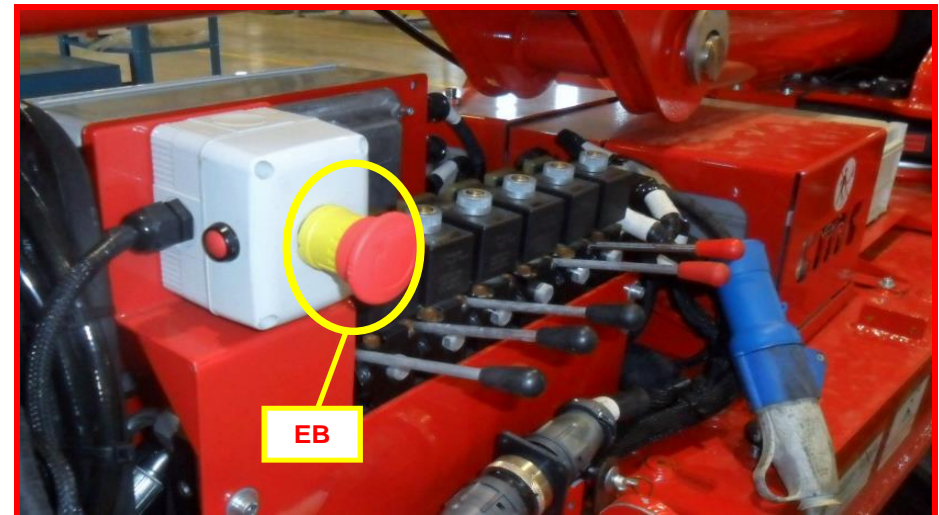

Picture 39: hydraulic distributor of stabilization control station.

Through the control station in Picture 39, located on the left side of machine frame, it is possible to perform manual stabilization/destabilization of the S28, to widen/tighten the tracks (par. 4.4.2.1).



The machine in travel position is meant with the basket on the rear.

In addition, there is an **emergency red mushroom-shaped button EB** (Picture 39) that blocks the machine, removing the power supply to the control circuits. This button has priority over all other commands; thus, it allows only manual descent to the ground. The emergency button has a mechanical locking device; therefore, it must be unlocked by turning it clockwise to reactivate the normal machine working.

### 3.3.2 ▶ Emergency workbench for aerial part

The emergency workbench (Picture 40) is placed on the left of the turret and it is useful in emergency situations for the recovery of the MEWP aerial part.

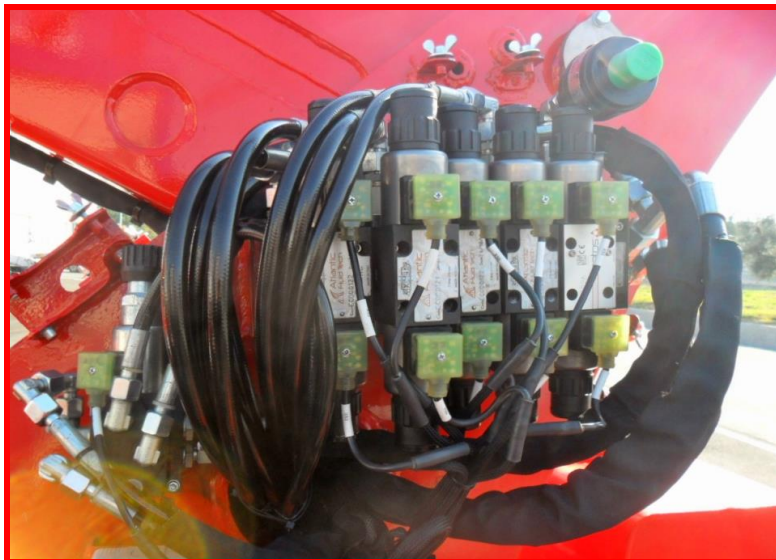

**Picture 40: distributor in the emergency workbench.**

The functions of the different cursors will be described in the section on the recovery procedures of the aerial part (par. 4.5.3.1).



## 4 Use procedures

### 4.1 Environmental operational conditions

The equipment can work normally in the following environmental conditions (for uses in different conditions, a special equipment is required):

- **temperature from -25 °C (-13 °F) to +55 °C (131 °F)** (even +70 °C (158 °F) for short periods which do not exceed 24 h);
- humidity from 30% to 90% (at 20 °C);
- **max wind speed 12,5 m/s (45 Km/h – 27.96 mph).**

Do not cover the equipment with cloths in order to avoid condensation inside the electrical boards.  
After storage in closed and very wet places for a long period, the machine could have some problems due to condensation in the electrical boards: in this case, please contact the Technical Assistance Service before use.

 **Do not operate in areas with dangerous environmental conditions:** poor visibility, storms, lightning risk, etc.

 Do not to operate inside refrigerating rooms.

 **Do not operate when the wind speed exceeds 12,5 m/s (45 km/h).** We hereby enclose “Beaufort wind scale” (Table 1):

Wind power		Wind speed		Land conditions
Beaufort number	description	m/s	Km/h	
0	Calm	0-0,2	1	Calm. Smoke rises vertically.
1	Light air	0,3-1,5	1-5	Wind motion visible in smoke.
2	Light breeze	1,6-3,3	6-11	Wind felt on exposed skin. Leaves rustle.
3	Gentle breeze	3,4-5,4	12-19	Leaves and smaller twigs in constant motion.
4	Moderate breeze	5,5-7,9	10-28	Dust and loose paper raised. Small branches begin to move. Dust and loose paper raised. Small branches begin to move.
5	Fresh breeze	8-10,7	29-38	Branches of a moderate size move. Small trees begin to sway.
6	Strong breeze	10,8-13,8	39-49	Large branches in motion. Umbrella use becomes difficult.
7	Near gale	13,9-17,1	50-61	Whole trees in motion. Effort needed to walk against the wind.
8	Gale	17,2-20,2	62-74	Twigs broken from trees. It is difficult to move.
9	Severe gale	20,3-24,4	75-88	Light damages to buildings, tiles removed.
10	Storm	24,5-28,4	>89	Trees are broken off or uprooted, heavy damages to buildings.

Table 1: Beaufort wind scale.



We recommend the use of an anemometer, to determine direction and speed of wind.



**Any addition that increases the wind load on the MEWP, such as warning signs, is prohibited.**



## 4.2 ▶ Safety distances ◀

Below there are the safety distances to be kept by qualified staff (alternating current):

Voltage field of electric line	Minimum safety distance
Up to 300 V	Avoid contact
300 V < x > 750 V	1 ft. 0 in. (30,5 cm)
750 V < x > 2 kV	1 ft. 6 in. (46 cm)
2 kV, < x > 15 kV	2 ft. 0 in. (61 cm)
15 kV < x > 37 kV	3 ft. 0 in. (91 cm)
37 kV < x > 87.5 kV	3 ft. 6 in. (107 cm)
87.5 kV < x > 121 kV	4 ft. 0 in. (122 cm)
121 kV < x > 140 kV	4 ft. 6 in. (137 cm)



It is forbidden, in any case, to touch live electrical conductors.

## 4.3 ▶ Transport, storage and packing ◀

In order to load/unload the platform, it is possible to use a travelling crane of adequate capacity. Sling the MEWP by the connections on the frame (Picture 41).



Picture 41: couplings on the frame.

- ☞ Lifting operations must be carried out when the machine is closed.
- ☞ Be careful not to damage machine.
- ☞ Always use the personal protection equipment; do not handle ropes or chains without gloves.
- ☞ The presence of people in proximity of MEWP during the operations is forbidden.

Alternatively, the load/unload can be done through ramp, exploiting the motricity of the machine as well as its ability to overcome **attack slopes lower than 17° (31%)**. If you choose this way, please proceed with the following procedure, carefully reading the danger notes suggested.

- ☞ Comply with the rules in force about width, height, weight and transport speed allowed.  
Check that the limit gauge is compatible with the features of the route to be made (i.e. galleries, bridges, electrical and phone lines, etc.).



**WARNING!** In both cases, it is advisable to remove the basket to favor the operations and reduce encumbrances.



Always use the radio control for loading/unloading operations.

#### 4.3.1 ▶ Loading/unloading through ramp



Check that no one is in proximity and that the MEWP is in transport configuration.



In order to ensure a better stability during load/upload operations, it is possible to extract the tracks widening the ground encumbrance. To extract the tracks, see par. 3.2.1.



Place the couple of ramps (of adequate dimensions) and bring them in correspondence of the machine tracks.



Check that the ramps slope attack does not exceed 17° (31%) with crawlers opened and not exceed 10° (18%) with crawlers closed. Check they are perfectly clean from grease, mud, snow or ice.



**WARNING!** Use loading ramps with suitable dimensions and strength. Secure the machine to the truck plane by couplings on the chassis. Ensure that the machine is switched off during the transport.

Travel and climb with the MEWP set as shown in Picture 42: the basket shall always be placed at the rear of the machine.

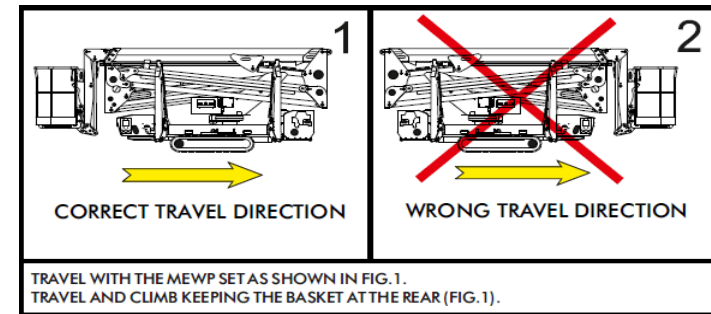

Picture 42: travel direction on the ground.

1. Use the radio control.
2. Check that the ramp attack is not higher than 17° (31%) to avoid damage to carpentry and that the soil is perfectly clean from grease, mud, snow or ice.

With the purpose of favoring machine loading/unloading through ramp, with the MEWP in transport position, even if it is not stabilized, you can press the parking button  (Picture 16) to:

- lift/lower the jib;
- rotate and level the basket.

#### 4.3.2 ▶ Self-loading function



In order to facilitate machine self-loading, it is advisable to remove the stabilizer extensions (if any). At the end of loading, the extensions must be included in the closing configuration, and only then the MEWP can be used.

- Drive and then lock the truck, once the load position has been reached;
- stabilize the machine (par. 4.4.2) and use the extensions if present;
- maneuver the truck bringing it from position 1 to position 2;



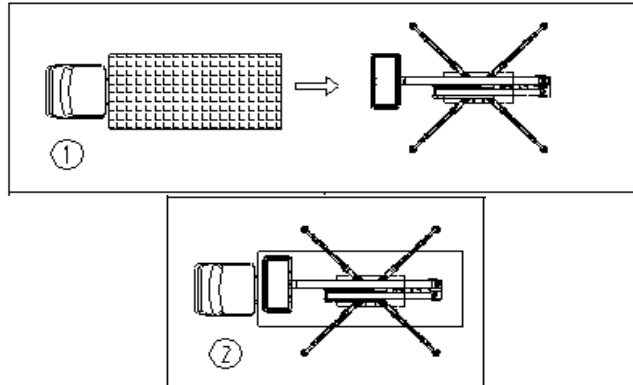

In order to avoid the overturning of the MEWP, use the roll-over control lever 9 (Picture 16), present on radio control station: it moves front or rear outriggers closer to the ground.



**Do not use the outriggers to lift the transport truck. Stabilizer cylinders could damage irredeemably.**

- carry out destabilization by the procedure described in par. 4.4.6 until the configuration 3 is obtained;

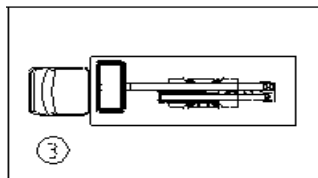

- fix the MEWP to the truck, using the appropriate coupling on the chassis (Picture 41).

### 4.3.3 ▶ Travel

The machine, thanks to a variable flow motor, has three levels of speed identified by three different symbols:

- "turtle": minimum speed;
- "hare": average speed;
- "double hare": maximum speed.



**Check that no one is in proximity.**



In order to ensure a better stability during travel operations, it is possible to extract the tracks widening the ground encumbrance. To extract the tracks, see par. 3.2.1.



**WARNING! The hydraulic system through which the triple speed is activated ("double hare") is a serial system. Therefore, it may be necessary to intervene with manual corrections during handling. Be very careful to travel with triple speed!**

Travel operations shall be made with the MEWP set as shown in Picture 42: the basket shall always be placed at the rear of the machine.



#### 4.3.3.1 ▶ Travel using radio control



Picture 43: speed selector on travel radio control.

In order to perform a travel, using the radio control:

1. make sure all outriggers are raised off the ground;
2. make sure the basket lock pin is inserted (Picture 50);
3. make sure the two boom groups are returned and supported;
4. turn on the machine (par. 3.1);
5. use the joysticks (Picture 16) to drive the tracks;
6. Position the speed selector **SVR** (Picture 43) of radio control on "turtle" symbol; move it to "hare" symbol to increase the speed of the tracks or to "double hare" to reach the maximum speed.



**Check that the travel slope does not exceed the maximum longitudinal limit of 19° - 34% (pre-alarm at 17° - 31%) and the maximum transversal limit of 8° - 14% (pre-alarm at 6° - 11%). Check that the soil is clean from grease, mud, snow or ice.**



**Prefer to use the radio control for travel operations.**

#### 4.3.3.2 ▶ Travel using basket console

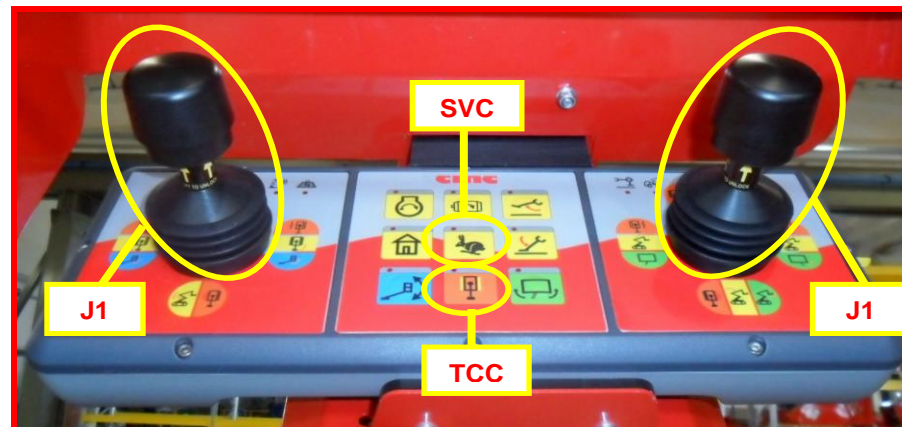

Picture 44: basket console.

The basket control station shown in Picture 44 have:

- **TCC** operation selector: by selecting this button, the movement of the tracks is activated; achieve the desired travel through the two joysticks **J1** and **J2**;
- **SVC** speed selector in "hare" mode: through this lever, you can decrease/increase the travel speed.

In order to perform a travel, using the basket control station:

1. make sure all outriggers are raised off the ground;
2. make sure that the basket block pin is inserted (Picture 50), and the basket is active;
3. make sure that the main and secondary boom groups are perfectly retracted and supported;
4. disable the radio control or disconnect the remote control;
5. switch on the machine (par. 3.1);
6. use the joysticks **J1** and **J2** (Picture 44) together **TCC** button to maneuver the tracks;
7. by positioning the speed selector on "hare", it is possible to increase the speed of the tracks.



The travel slope limits are lower from the basket control station: 9° (pre-alarm at 7°) longitudinally and 7° (pre-alarm at 5°) transversally.



**WARNING!** If the slope is >9°, the travel must be performed through radio control.

**Procedure for bypass of the travel block:**

During travels, when reaching a pre-alarm slope limit, an intermittent acoustic warning will activate; it becomes a fixed acoustic signal at maximum slope limits in order to indicate the **PROHIBITION TO KEEP ON INCREASING INCLINATION FURTHER**.

**If the operator continues, reaching max allowed level, the machine will inevitably go into total block.**

It will be possible to bypass this block **ONLY THROUGH OPERATIONS UNDER THE FULL RESPONSIBILITY OF THE USER**, who can proceed as below:

1. Remove the cover present on the left side of the turret;
2. Remove the lead seal and lift the red button shown in Picture 45:



**Picture 45: travel block bypass.**

3. Activate the black ON/OFF lever inside.

The bypass, at this point, will be active and the operator will be able to take the machine back to the conditions prior to the block (travel in the original direction), until stopping the previously activated acoustic warning.

**C.M.C. DECLINES ANY TYPE OF RESPONSIBILITY TO THE OPERATOR. THE MANUFACTURER HAS CLEARLY ESTABLISHED TWO ACOUSTIC WARNING THRESHOLDS, IN ORDER TO FULLY INFORME THE USER ABOUT THE DANGERS DUE TO THE NON-RECOMMENDED ACHIEVEMENT OF 19° LIMIT.**

**4.4 ▶ MEWP use procedures ◀**

The machine is equipped with the "SCS System" (Self Control System) which allows:

- automatic stabilization,
- automatic speed control,
- automatic closing of the aerial part.



The following procedures shall be carefully carried out in the correct chronologic order.



**If full lithium version (\*optional), before any work start, check the battery charge level.** It is necessary to have at least 75% of battery charge, otherwise it is advisable to charge them before working.

**4.4.1 ▶ Placement on the working area**

1. Start the endothermic/electrical engine using the supplied engine ignition key (Picture 4).
2. Identify the working area, which is nearest to the working place, and reach it by machine handlings, using travel buttons (par. 4.3.3).



**C.M.C. obligates to use the remote travel controls, in order to ensure the travel operations in complete safety.**

3. Make sure the soil bears the load of the outriggers and check that there are no manholes, floors or other soft structures in the contact point of every stabilizer plate with the ground.



**In case there are not such conditions, it is strictly forbidden to use the MEWP.**

4. Place the MEWP on the chosen area.
5. Define the working area with appropriate signals (white-red ribbon, white-red chains, cones, etc.).

#### 4.4.2 ▶ MEWP stabilization

The MEWP has different stabilization areas, according to the different combinations of possible stabilizer openings. Each outrigger can be positioned in two different configurations (in addition to the closing one), corresponding to two work areas (Picture 46): one narrow (1) and one wide (2). A double electronic locking system uniquely ensures the chosen work area.



**The movement of the outriggers must be possible only when the booms are resting on their supports (transport configuration).** This condition causes the stabilization consent light **19** (Picture 12) to light up on the control stations.

6. Lift the 4 pins which block the outriggers position. If this operation results difficulty, move the stabilizer trying to rotate it in the horizontal plane during the lifting.



**It is forbidden, and unnecessary, to completely remove the pins from their seat.**

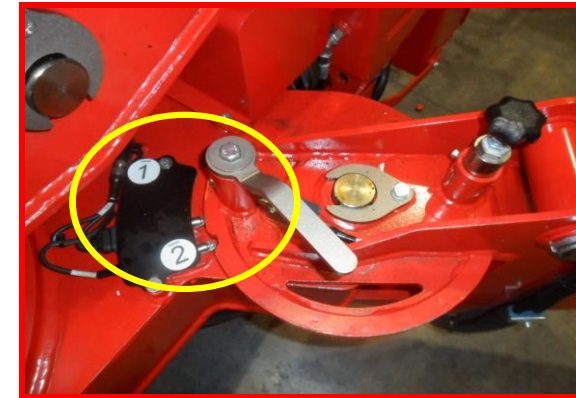

**Picture 46: outriggers pin.**

7. With the pin lifted (Picture 46), rotate the outrigger taking it in a position which allows the reinsertion of the same pin. For each outrigger, it will be possible to choose two positions (1 or 2): the positions taken by the outriggers determine the working area.
8. Once reached one of the two outrigger positions required, push the pin downward until blocking it.



Check the status of cleanliness and integrity of the limit switches in-built in the stabilizers (cursor, bracket, spring, etc.) before the operations described above.



**Verify that the maximum slope to stabilize not exceed 32° (62%).**

##### 4.4.2.1 ▶ Manual stabilization from chassis control station

The hydraulic distributor in Picture 47, present on the frame control station, allows to perform manual stabilization/destabilization of the machine:

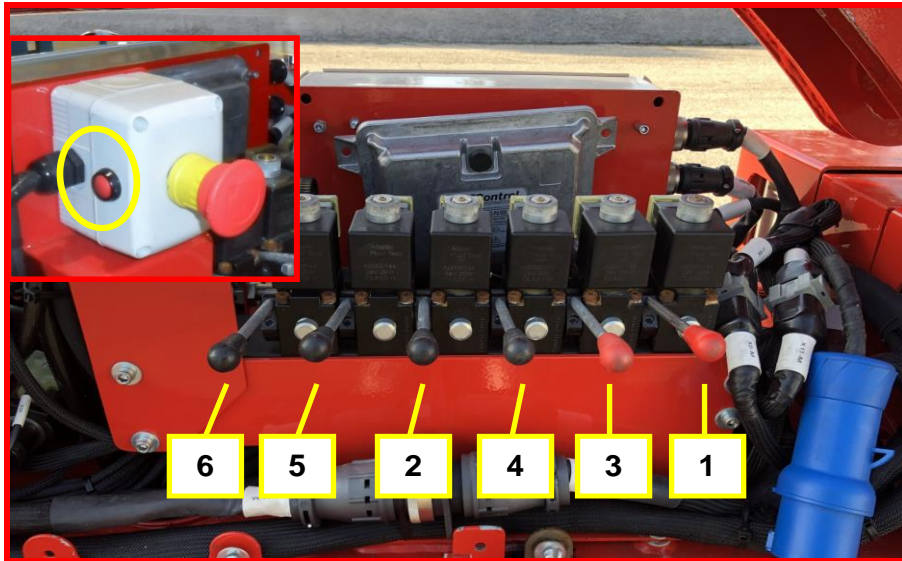

Picture 47: levers of hydraulic distributor.



In order to facilitate stabilization of the machine, it is good to widen the tracks beyond the shape of the frame. They are adjustable in height and width.

So, to activate the hydraulic distributor, it is necessary to keep the red button (dead man) pressed, located at left side of emergency button (Picture 47), during the levers handling:

- levers **6** - **5**: upward to withdraw and downward to enlarge the left and right tracks;
- levers **2** - **4** - **3** - **1**: upward to close and downward to open each stabilizer;
- the machine will be correctly stabilized when the consent indicator for the use of the aerial part **20** (Picture 12) will light up. To achieve this

condition, it is strictly necessary to lower the outriggers until they are well positioned on the ground, the tracks uplifted and the frame in planarity with a maximum tolerance of 1 ° (inclinometer control).



**It is essential to carry out the stabilization operations by operating on all four levers simultaneously.** Once the feet will all have touched the ground, it will be possible to continue running short alternate cycles before on the two front stabilizers and then on the two rear ones.

#### 4.4.2.2 ▶ Automatic stabilization with radio control

If you want to stabilize the machine in automatic mode, you can use the radio control or the remote control:

- use the lever **SAR** (Picture 48). It causes the simultaneous descent of the four outriggers until the signal reading of the four limit switches on the ground contact and the lifting of the tracks;



Picture 48: stabilization/destabilization lever on radio control.

- make sure that the consent indicator for the use of the aerial part **20** (Picture 12) is on.

During stabilization phase, pressing the parking button **P** (Picture 16), together the stabilization lever, you can raise all the machine without waiting the predefined cycle of automatic stabilization.

#### 4.4.2.3 ▶ Automatic stabilization with basket console

The stabilization can also be performed automatically, from the basket console by deactivating the radio control:

- by means of the basket control station, it is also possible to perform automatic stabilization/destabilization with the **SAC** buttons (Picture 49).



Picture 49: stabilization/destabilization lever on basket station control.

- make sure that the consent indicator for the use of the aerial part **20** (Picture 12) is on.



#### 4.4.3 ▶ Basket assembly/disassembly

- Turn off the machine and proceed with the basket assembly.



Picture 50: basket coupling.

- Once the basket is coupled, insert the pin **P** and the safety cotter pin **C** to block it to the jib support (Picture 50).
- Enter the basket by lifting the self-locking closing bar and using the underlying step; **ensure the bar is back to the closing position; fasten the safety harness to the proper eyelets in the basket frame.**



The operator who climbs on board the basket must always have a pointed object (for example a screwdriver) which, in the event of an electric/hydraulic emergency on the machine, can help him to manually push the cursors for leveling and rotation of basket.



It is forbidden to overload the basket exceeding its maximum allowed nominal capacity.

#### 4.4.4 ▶ Basket leveling

- After making sure the light **19** (Picture 12) is on, level the basket using the platform control (exercise) station (par. 3.2.1): press both the dead man button **16** (Picture 11) and the joystick lever for basket leveling control, in case the floor is out of level.



Level the basket only when the MEWP aerial part is set in the transport configuration.



It is strictly forbidden to level the basket with the machine developed.

#### 4.4.5 ▶ Use of the aerial part

- After making sure the light **20** (Picture 12) is on, using the platform control (exercise) station, carry out the MEWP aerial part operations by the manipulators described in the paragraph 3.2.1.





First lift the upper boom, in order to rise it from the support.



It is strictly forbidden to rotate the turret as first movement, since it could seriously damage the carpentry.



 It is forbidden to enter or exit the work platform at different levels, when the machine is developed.

 It is forbidden to increase the outreach or working height of the MEWP by using additional equipment.

 It is forbidden to use the MEWP as a lifting device.

 Avoid contact of the aerial part with fixed objects (buildings, etc.) or with moving objects (vehicles, lifting equipment, etc.).

#### 4.4.5.1 ▶ Moment limiter

 Thanks to a moment limiting device (anti-tipping device fitted as standard on these machines), all operations bringing the machine over the working diagram are ineffective.



When the maximum allowable outreach is almost reached (90%), the pre-alarm indicator  lights up (Picture 10).

When the maximum allowable outreach is reached (see the working diagram in Picture 2a), the alarm indicator  lights up (Picture 10).

#### 4.4.5.2 ▶ Load limiter

 Moreover, when the MEWP exceeds its maximum permitted capacity (230 Kg), the system detects the overload and stops the work operations, warning with a continuous acoustic signal.

During the movement of the MEWP aerial part, reaching the maximum load selected, the load limiter safety device activates.

- Overload until 20 Kg (signaled by the lighting of the intermittent block light  – Picture 10 and by an intermittent acoustic warning): in this case, operations remain active, even if these two signals warn the user about the danger; the signals will stop only removing the overload from the basket.
- Overload > 20 kg (indicated by the fix lighting of the block light  – Picture 10 and by a continuous acoustic warning): the load limiter safety device stops all operations of the extendable structure: the operator must unload the overload from the basket to reuse the MEWP.

➔ The operator must remove the overload from the basket to continue the work with the MEWP.

 It is strictly forbidden to use the MEWP when the load limiter device acoustic warning is on. Remove the exceeding load from the basket until the acoustic signal and the relative light go out.

#### 4.4.5.3 ▶ Slowdown of the aerial part maneuvers

Slowdowns can be set by software for start and end of each aerial part maneuver (lifting/lowering of booms, extension/retraction of booms, clockwise/anticlockwise rotation of the turret, opening/closing jib), valid in the following conditions:

- Boom angle  $>x^\circ$  or  $<x^\circ$ ;
- Boom extension  $>x$  mm or  $<x$  mm;
- Opening jib  $>x$  mm or  $<x$  mm;
- Pre-alarm condition (90% of the block);
- Approaching the turret angle to a curve change zone.

#### 4.4.5.4 ▶ Anti-collision system

Since the machine can also work at negative heights, the anti-collision system supplied prevents the basket and booms from impacting with the outriggers, blocking the activated movements.





However, it is possible to bypass this system by pressing the parking button **P** on the left side of the radio control (Picture 51).



Picture 51: P button to bypass anti-collision system.

#### 4.4.6 ▶ Setting the MEWP in the transport configuration

13. In order to set the MEWP in the transport configuration, first center the turret, return on the ground the MEWP aerial part, withdrawing the telescopic boom groups, and laying the booms on their supports, using the platform control (exercise) station (par. 3.2.1).



**WARNING! CENTER THE TURRET BEFORE LOWERING BOOMS.**

14. Unfasten safety belts and get off the basket using the steps below.

#### If you want to destabilize the machine:

- In case of manual destabilization, keep the dead man button pressed and use the levers of the main inlet group (par. 4.4.2.1).

- If you want to automatically destabilize the machine, rotate the selector near the ignition key on 1 and use the properly buttons on the radio control or on the basket console (par. 4.4.2.2-4.4.2.3).
- At the end, it is possible to restart the MEWP to take it back to the parking place.



**IT IS ESSENTIAL TO CARRY OUT THE DESTABILIZATION BY OPERATING ON ALL FOUR LEVERS SIMULTANEOUSLY.**

Keeping the parking button **P** (Picture 16) pressed, together the **J5** joystick which control the turret rotation, you can activate the turret self-centering up to the position 0°.

With the MEWP stabilized, pressing the parking button **P** on radio control (Picture 16), it is possible return the two boom groups.



**If full lithium version (\*optional), at the end of the work, always remember to charge batteries.**

#### 4.4.7 ▶ “Home” function



**The following procedure should be carried out with the most caution and wearing all personal protective equipment.**

When the appropriate button (dead man) "Home", present both on the radio control and on the basket control station (Picture 11 and 16), is held pressed, the automatic closing of the aerial part is activated. The following maneuvers must be carried out up to the limit switches in the chronological order indicated below:

- re-entry of second telescopic boom group up to 0°;
- turret rotation in the direction of origin up to 0°;
- descent of first boom group up to 0°;
- descent of all booms up to support.



**CAUTION! IF YOU MEET OBSTACLES DURING THE AUTOMATIC CLOSURE OF THE MACHINE, IMMEDIATELY RELEASE THE BUTTON AND PROCEED WITH THE MANUAL MANOEUVRES.**

#### 4.4.8 ▶ Acoustic warnings

15. During the use of the MEWP, it is possible to hear the following acoustic warnings, corresponding to the following signals:

🔔 SOUND	Corresponding to:
Continuous acoustic signal (intermittent in pre-alarm): when exceeding the maximum load allowed.	Load limiter light activated on basket console and on radio control.
Continuous acoustic signal (intermittent in pre-alarm): when exceeding the maximum travel inclination allowed.	Maximum travel inclination light activated on basket console and on radio control.

Table 2: acoustic signals.

#### 4.1 ▶ Lithium battery pack recharge (\*optional) ◀

For full lithium version (\*optional), in order to recharge the battery pack, it will be necessary to stall the machine.

Then operate according to the following procedure:

1. switch off the electric engine;
2. couple the 110/120/230 V plug (power line) to the connector on the machine and press the appropriate button of the magnetothermic switch;

3. now the batteries will be in charge and the charge progress can be evaluated through the leds on chassis box or on radio control station.



The charge times are:

BATTERY CHARGE	TIME
0% - 80%	4 h
80%-100%	2 h

With a full charge (100%), the 200 Ah Eco-Battery pack is able to perform at least 12 work cycles. A work cycle includes the following sequence of operations:

- 1) stabilization;
- 2) complete machine development;
- 3) complete machine return;
- 4) destabilization.



**AT THE END OF EACH WORKING SESSION AND HOWEVER AT LEAST EVERY 15 DAYS, IF THE MEWP IS NOT USED, ABSOLUTELY RECHARGE THE BATTERY PACK.**

## 4.2 ▶ Emergency operations ◀



Before starting the emergency procedures, it could be useful to contact C.M.C. Service and communicate data on the display (par. 3.2.2).

In case of emergency, the control of the aerial part of the MEWP can be performed by the operator on the ground using the radio control.

### 4.2.1 ▶ Emergency buttons

In case of emergency, push the emergency button: the MEWP engine switches off and all operations are disabled. This button has priority over all other commands.

The emergency button has a mechanical locking device, therefore, to restore normal working conditions, it must be unlocked by turning it clockwise.

On the machine, there are emergency buttons in the following positions:

1. on the right side of the platform command station (operating position) (Picture 9);
2. on the center of the platform radio control station (Picture 13);
3. on the left side of the stabilizer controls on the frame (Picture 39).

### 4.2.2 ▶ Emergency bypass

In case the basket operator pressed the emergency button and were unable to reset this button at the original position (due to blackout, fainting or other), it will be possible to disable that safety function through **the “emergency bypass” yellow button** (Picture 52) located on the switching on/off box.

The ground operator removes a safety lead seal and disable the emergency through **an internal on/off lever**.



Picture 52: emergency bypass lever.



It will be care and responsibility of the operators, at the end of the operations, to reset the original conditions, including the resealing with seal compulsorily branded “C.M.C.”.

### 4.2.3 ▶ Emergency procedure in case of electrical system failure (PLC)

In case of failure of the electrical system (PLC breakdown, but standard engine still working), the machine will go into lockout and on the display (T screen - Picture 26) of the radio control the activated error codes will be displayed.

Remember that below the machine is considered in the working position with the basket on the rear.

In order to secure the machine, perform the following procedures in the indicated chronological order:

1. recovery of the aerial part (including levelling and rotation of basket);
2. closing of the outriggers;
3. retraction and travel of the tracks.

#### 4.2.3.1 ▶ Recovery of the aerial part

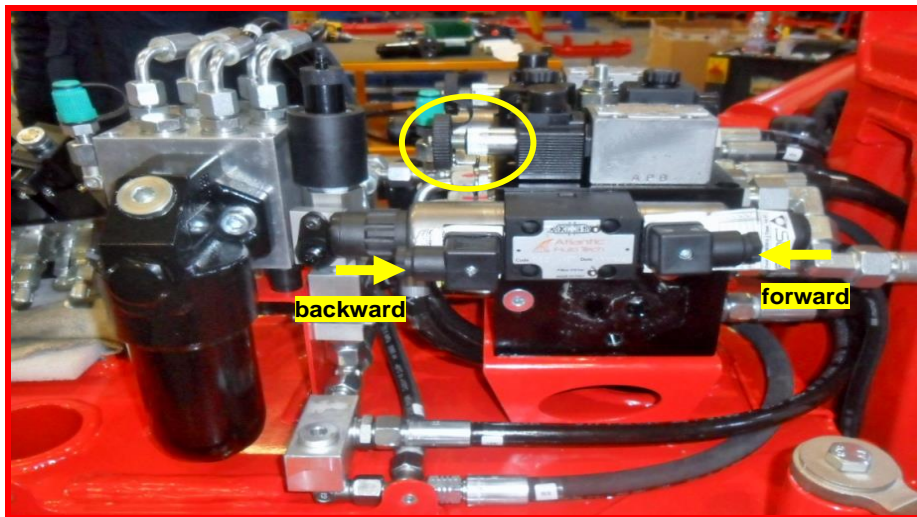

**Picture 53: view from the right side of main inlet group.**

The ground operator must:

- reach the main inlet group (Picture 53) on the frame and remove the cap;
- close the aerial part valve (Picture 53) on the right side of the main inlet group, screwing it by hand, to send oil to the emergency control workbench (paragraph 3.3.2 - Picture 40);
- close the levelling valve (Picture 54) on the center of the main inlet group, screwing it by hand.



**First carry out the recovery operations of the basket, to make the operator on board safe.**

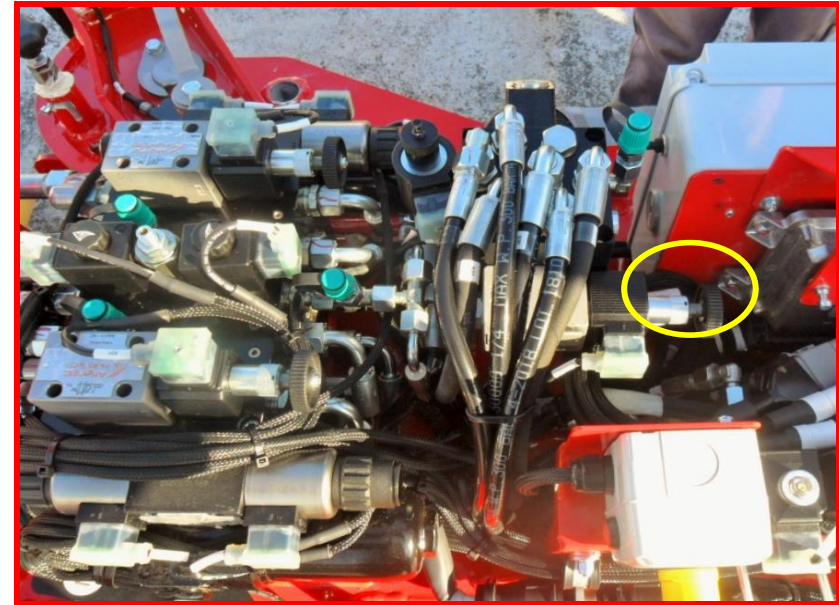

**Picture 54: levelling valve on main inlet group.**

At this point, the operator in the basket must carry out the emergency operations for leveling and rotation of the basket:

- approaching, with a pointed object, to the cursors in Picture 55, which are mirrored on both sides of the jib support;

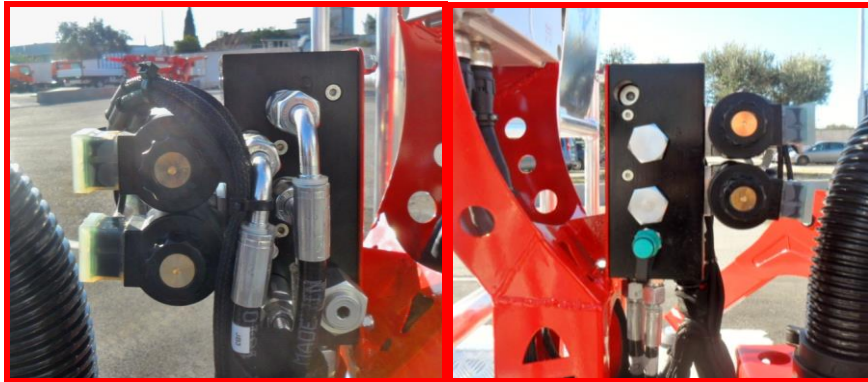

Picture 55: views on the left/right side of the cursors bank for leveling and rotation.

- following the scheme shown in the appropriate marking applied on the jib support:

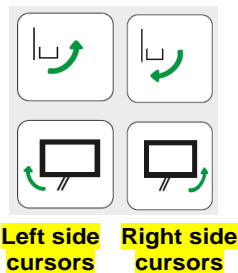

- press the cursor in the upper left to the external leveling and one in the upper right to the internal leveling;
- press the cursor at the bottom left for clockwise rotation and the one at the bottom right for counterclockwise rotation.



**While return the MEWP in rest configuration, the deceleration speed ramps of the maneuvers will be inactive: therefore, pay particular attention to the operations wearing all personal protection equipment provided by law.**



**If the basket operator has a fainting, the ground operator can operate the basket levelling using the levelling box mounted on the turret (Picture 56):**

- feed the levelling system through the lever **FL** inside the red sealed cover;
- screw the valve for levelling on the main inlet group (Picture 54);
- move the black lever **LL**:
  - upward to operate the external levelling,
  - downward to operate the internal levelling.

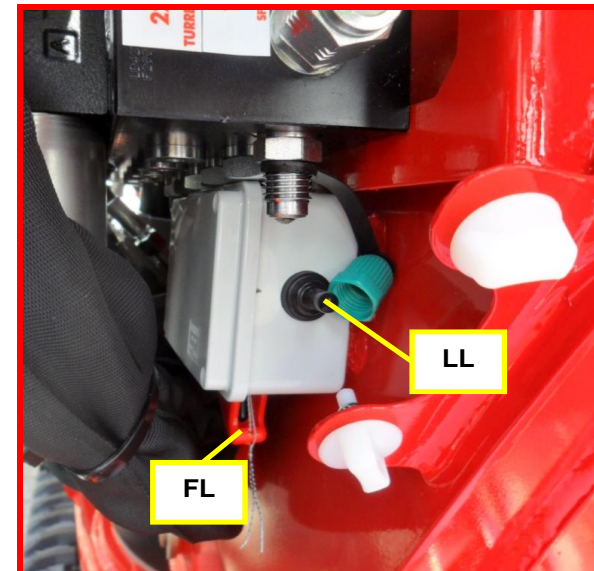

Picture 56: levelling box.

- always with the aerial part valve screwed (Picture 53), perform the remaining recovery operations detailed below by means of the pressure cursors of the electrovalves on the emergency workbench (paragraph 3.3.2 - Picture 40).

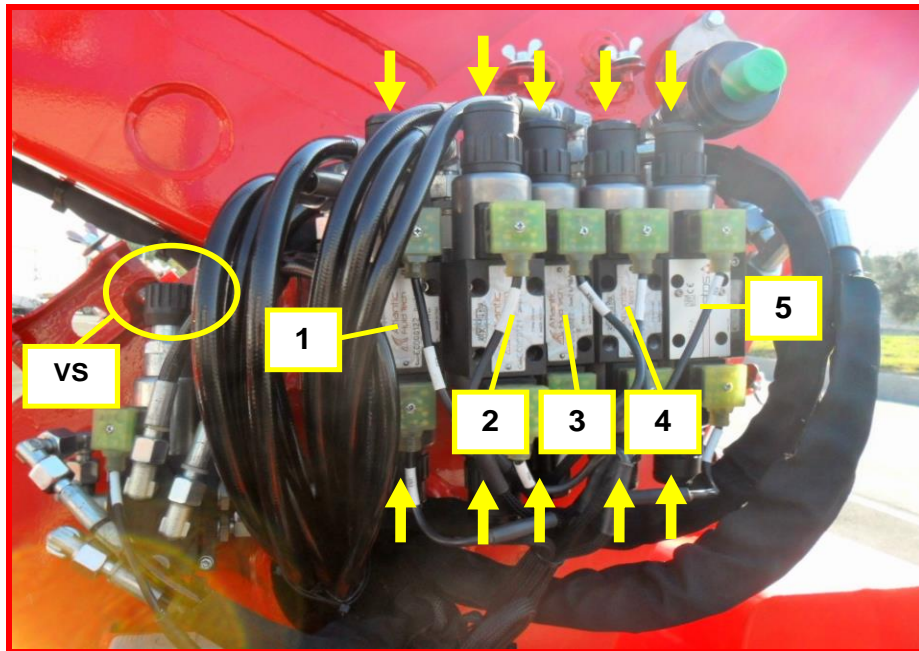

Picture 57: cursors on emergency workbench.

The cursors are mentioned starting from the left of Picture 57. These functions can be performed by pressing, with a pointed object, in order first on the upper and then on the lower extremity:

- cursor **1**: lifting and lowering of the upper boom;
- cursor **2**: extension and return of the upper boom;
- cursor **3**: lifting and lowering of the lower boom;
- cursor **4**: extension and retraction of the lower boom;
- cursor **5**:

- o with the exchange valve **VS** (Picture 57) unscrewed, move down and up the jib;
- o with the same exchange valve screwed, anticlockwise rotation and clockwise rotation of the turret.



At this point, it is possible to get the operators off the basket.

#### 4.2.3.2 ▶ Closing of the outriggers

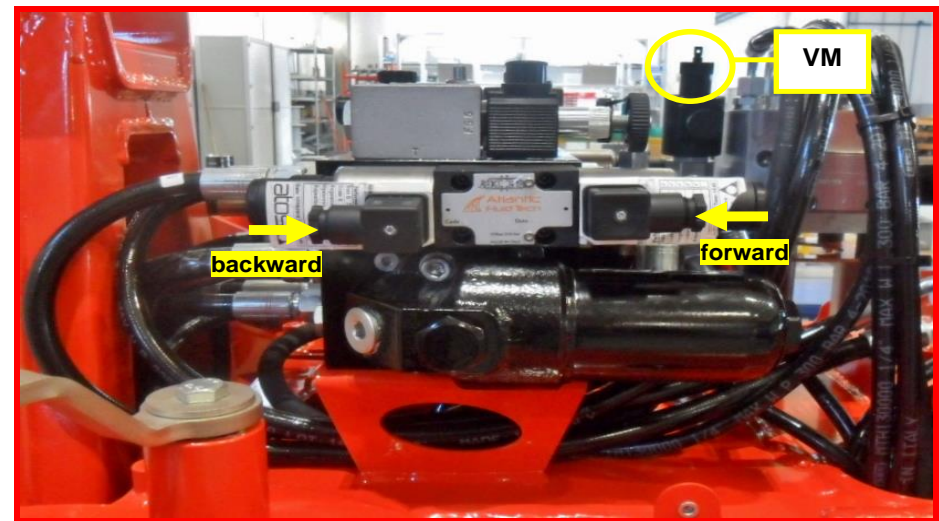

Picture 58: view from the left side of main inlet group.

The ground operator must:

- reach the main inlet group (Picture 58), present on the frame and remove the carter;
- close the valve on the left side of the main distributor by hand;
- close the monitored stabilizer valve **VM** (Picture 58);
- move the levers of the stabilization control station (Picture 39) to recover outriggers and tracks. The functions of the levers are described in par. 4.4.2.1.



#### 4.2.3.3 ▶ Tracks handling

For the recovery of the machine by means of the travel of the tracks, two operators are required on the ground at the main distributor.

The valves for moving the two tracks are mounted opposite each other:

- the one on the right side (Picture 53), moves the left track;
- the one on the left side (Picture 58), moves the right track.

From both sides of the main distributor:

- by pressing the cursor on the left end, the relative track is translated to the rear;
- by pressing the cursor on the right end, the relative track is moved towards the front.

→ At the end of operations, the operators must restore the valves to their original condition.

⊘ It is strictly forbidden to use the MEWP with solenoid valves tampered or without seals.

#### 4.2.4 ▶ Emergency procedure in case of endothermic engine failure

In case of failure of endothermic engine (engine anomaly, fuel exhaustion, etc.), in order to pressurize the oil in the hydraulic circuit, it is possible to use alternatively:

- the 120/230 V electrical engine \*optional (par. 3.1.2);
- the emergency electropump \*optional (par. 4.5.6);
- the manual pump (par. 4.5.5).

On the left machine side of the frame, a manual pump / electropump double tap (Picture 59) is positioned to convey the oil in the hydraulic circuit towards the outriggers or the aerial part.

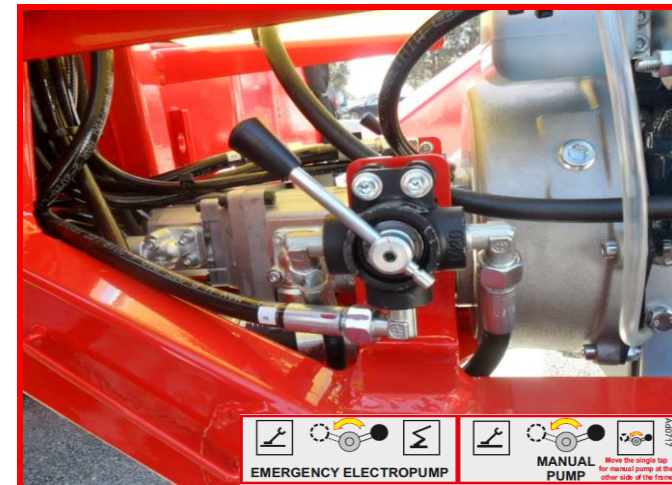

Picture 59: manual pump / electropump double tap.

- Before starting the recovery of the aerial part, if the electropump is present, turn the double tap to the right, on the "aerial part" symbol  indicated by the applied marking (Picture 88) near the same tap.

- In the same way, before starting the recovery of the outriggers, turn the double tap to the left, on the "outriggers" symbol  indicated by the marking.

Subsequently proceed with the emergency procedure described in par. 4.5.3.

#### 4.2.5 ▶ Emergency procedure in case of electrical and hydraulic system (use of manual pump)

In the unlikely case of concurrent electrical and hydraulic failure (engine malfunction and absence of electropump, electropump failure, etc.), it will be necessary to send oil to the circuit through the manual pump, inserting it into the appropriate attack on the frame (Picture 60).



Picture 60: frame insert for manual pump.

- Before starting the recovery of the aerial part, turn the double tap on to the right, on the "aerial part" symbol  indicated by the marking applied near the same tap. Then, move to the right side of the frame where the single tap of the manual pump is positioned (Picture 61- this tap directs the oil in the

hydraulic circuit towards the aerial part or the part of the circuit which performs the leveling of the basket). Move it to the left to operate the aerial part recovery or to the right to perform the leveling of the basket.

- Before starting the recovery of the outriggers, however, just move the double tap (Picture 61) to the left, on the "outriggers" symbol  indicated by the appropriate marking applied.

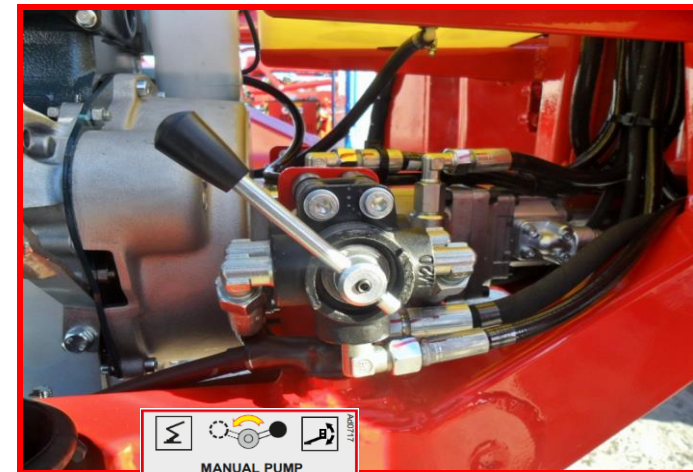

Picture 61: manual pump tap.

Then carry out the emergency operations described in paragraph 4.5.3.



**The first thing to do is to close the aerial part.**



**After closing the platform, take it to the nearest Service Center for the restoring of the normal operating conditions which are indispensable for a safety use of the machine.**





#### 4.2.6 ▶ Electropump (\*optional)



The emergency electropump is an alternative energy source for the engine motor.

It is to be used only in case of emergency. Every different use is not recommended because it can produce unexpected discharge of batteries, absorbing current directly from them.



Picture 62: electropump (\*optional) activation buttons.

If installed, the emergency electropump can be activated (powered) by pressing appropriate buttons (Picture 62):

- on the right side of radio control;
- on switching on/off box in the lower left corner;
- on the right side of basket box.

#### 4.3 ▶ Safety rules



THE NON-COMPLIANCE WITH ANY OF THE FOLLOWING SAFETY RULES, MAY CAUSE SERIOUS DAMAGES TO PEOPLE, THINGS AND PARTS OF THE EQUIPMENT OR THE VEHICLE.

##### 4.3.1 ▶ Before and during the movements with MEWP in transport position



It is forbidden to rent the MEWP without non-trained operators and staff.



The hirer is responsible for the training of his operators and of the staff renting the MEWP. C.M.C. s.r.l. declines any responsibility coming from damages to people and/or things due to the inexperience of these operators;



Do not use the MEWP under drug or alcohol effect;



Do not use the MEWP under stress conditions;



Do not use the MEWP if you suffer from dizzy spells;



Before driving, check the tires wear state and the correct inflation pressure;



Drive with caution, respecting the highway code;



Take the MEWP height overall dimensions into consideration during circulation, in order to avoid clashing against bridges, galleries, underpasses and other obstacles;



Do not use the MEWP to perform drawing or pushing operations;



Do not use the MEWP as an off-road vehicle;



→ When parking in sloping roads, use the parking brake and block the wheels with some wedges.

#### 4.3.2 ▶ Before positioning the MEWP

→ Carefully and chronologically follow the instructions given in this manual;

 Use the MEWP only with the environmental operating conditions indicated in paragraph 4.1;

→ **Check that the staff allowed to use the MEWP is skilled and trained, and that they know the MEWP use and maintenance rules;**

→ Check that the safety devices are working and efficient; some components (outriggers integrated groups, max pressure valve on the turret), important for the MEWP safety, are calibrated in C.M.C. plants and the containers are sealed before delivering of the MEWP to the customer.

 It is strictly forbidden to tamper with such components. The absence of the sealing within the machine warranty terms causes the immediate retraction of the warranty as well as the accountability – by the user – of the liabilities coming from an incorrect functioning of the safety devices.

 Do not remove or modify safety devices;

 It is forbidden to modify, remove or replace any MEWP component (ballasts, tires, batteries, spare tire etc.): this operation could reduce the machine weight thus impairing its stability;

→ Wear all the protective cloths and the personal safety devices: helmets, safety shoes and - according to the type of work - gloves, hearing protections, respirators, etc.;



Do not use clothes with hanging flaps, scarves, ties or any other accessory which could be dragged into the moving parts; inform about the closest fire-extinguishers and first-aid kit.

#### 4.3.3 ▶ During the positioning of the MEWP



It is forbidden to operate in situations which are dangerous for the safety of people;



Do not operate in explosion hazard areas;

→ Block the vehicle by the parking brake and, in sloping roads, block the wheel with wedges;

→ Check that the working area is suitable to the MEWP performances and operations, and that it is enough lit;

→ Check that the operational stands and the working area are enough lit and well visible;

→ If operating in closed or little aired environment, ensure, before starting the vehicle engine, that his has appropriate ventilation or convey exhaust gases outside:



Exhaust emissions produced by the MEWP engine are toxic;

→ Appropriately define the working area through suitable signs; observe the laws in force about the traffic, in case you use the MEWP where road circulation is allowed;

→ Check that nobody is within the MEWP action range.

→ Stabilize the truck through the outriggers.



Pay the utmost attention during stabilization: check that no one is inside the stabilization area.



- ➔ Check that the outriggers rest on a non-soft, solid ground that bears the load indicated on each stabilizer.
- ➔ In case of soft ground, use supporting plates.
- ⊘ It is forbidden to place the outriggers on ground roughness: they could be damaged.
- ➔ Level the vehicle in order to let the MEWP operate on a horizontal plane: max frame fall 1° - max slope which can be assimilated by the ground 3°.

#### 4.3.4 ▶ During the entrance in the basket

- ⊘ It is absolutely forbidden to use the equipment with loads different from those indicated on the diagram or for uses which are not allowed;
- ⊘ Do not overload the MEWP;
- ➔ **During the different working operations, the use of the safety belts is compulsory.** Do not fasten the safety belts to external structures but only to the supplied grips placed in the basket;
- ➔ Make sure that the bar lifted to enter the basket, has returned in its lock position.

#### 4.3.5 ▶ During the use of the MEWP

- ➔ In any dangerous or irregular conditions, stop the machine by using the emergency button. Before restarting the machine, check that the dangerous conditions are over;
- ⊘ It is strictly forbidden to level the basket when the machine is in working position;
- ⊘ Do not operate when the MEWP is in failure;

- ⊘ It is forbidden to use the “platform control (emergency) position” when there are operators inside the basket, unless there is emergency or for testing operations before starting the work (which shall be carried out without anyone in the basket): from downstairs, it is difficult to estimate how far the basket and the MEWP structure components are from possible obstacles;
- ➔ Follow the MEWP working diagram.;
- ⊘ It is strictly forbidden to use the platform as a crane, to hang posters, banners, poles, etc. to the basket or to any other part of the MEWP.;
- ⊘ Do not connect chain or ropes to the MEWP (since they could be trapped amongst the MEWP moving parts or they could hook fixed objects thus causing the machine overturn);
- ⊘ It is absolutely forbidden to lift or lower loads by using ropes and pulleys;
- ⊘ It is forbidden to lean out;
- ⊘ It is forbidden to use the MEWP for recreational purposes;
- ⊘ Do not perform the basket rotation operation together with other operations;
- ⊘ No material shall fall from above: fasten the working material properly;
- ⊘ Do not throw objects (tools) upside down or vice versa.
- ⊘ In case of works like pruning, plants maintenance, etc., it is forbidden to let trunks, pipes, poles etc. fall inside the basket or on the MEWP structure: they can severely impair the MEWP stability;
- ➔ During works like paintings, etc., protect yourselves and the machine;



- ⊘ It is strictly forbidden to put tools, body parts in the areas marked by the stickers indicating crushing, shearing hazard; keep hands away from any hole or slit;
- ⊘ It is forbidden to use tools not complying with the laws in force;
- ➔ When working at low temperatures, it is necessary to perform some in-vain operation so that the hydraulic circuit oil reaches the operating temperature;
- ⊘ It is forbidden to let people walk or stay within the MEWP working area;
- ⊘ It is forbidden to stay on the counter frame floor, during MEWP operations.
- ➔ Firmly cling to the work platform during lift and descent;
- ➔ Controls shall be started by slow and gradual movements:
- ⊘ Do not operate controls swiftly and suddenly
- ⊘ It is forbidden to make the platform swing;
- ➔ Check the vehicle and MEWP stability during all the operations phases;
- ➔ Do not move the vehicle during the MEWP working operations;
- ➔ Keep enough safety distance from the obstacles: avoid contacts with fixed (buildings, etc.) and moving (vehicles, cranes, etc.) objects, with the truck cabin, with the outriggers and with other structure parts;
- ⊘ It is forbidden to use ladders or tables on the basket in order to increase the MEWP outreach or working height;
- ➔ Be careful when working in close buildings: due to the “wind tunnel” effect, sudden blasts could cause swinging, thus impairing the machine stability;

- ⊘ It is forbidden to lift “full surface” panels (signs, advertising panels, boards, etc.): these could cause the “sail” effect;
- ⊘ It is forbidden to leave the MEWP unattended when it is in working position;
- ⊘ It is forbidden to exceed the max number of basket operators allowed;
- ⊘ During the normal use of the platform, it is absolutely forbidden to use electronic instruments which do not meet the requirements of the directive 72/245/CE and its following amendments: the additional electronic instruments could impair good functioning of the platform electronic components.

#### 4.3.6 ▶ At the end of the works

- ➔ Before moving the vehicle, check that the MEWP aerial part is set in the transport position: check that the pantograph is on its own support, that the telescopic boom is withdrawn and rests on its own support;
- ➔ Before moving the vehicle, check that the back outriggers beams are completely withdrawn and blocked, that all the outriggers are set in the transport position, with the plates completely lifted;
- ➔ After using the MEWP, disengage power take-off and then the parking brake;
- ➔ Disengage the power take-off before moving the vehicle.



#### 4.4 ▶ Safety devices ◀

##### ➔ Electrical/electronic devices:

- Removable key for the MEWP start;
- Emergency stop switches, mechanically blocked, on the two control stations and on the outriggers station;
- Microswitch blocking the outriggers controls with booms lifted and if the extension is not in withdrawn position;
- Microswitch for outriggers end-of-stroke;
- Protection fuses against brownout, both on the power circuit and on the control circuit;
- All machine controls hold-to-run;
- Moment limiter device;
- Load limiter device;
- Inclinator;
- Anti-collision system;
- Basket pin microswitch;
- Outriggers pins microswitches;
- Emergency bypass;
- Blocks bypass.

##### ➔ Hydraulic devices:

- Max pressure valves;
- Block valve and parachute valve mounted on the lifting cylinders;
- Manual pump for emergency operations;
- Oil flow adjuster for the control of the descent speed.

##### ➔ Mechanical devices:

- Hydraulically controlled negative disc brakes;
- 1,10 m height border guardrail on the basket;
- Mobile bar for access to the basket with gravity closing;
- Basket with safety belts connections;
- Mechanical blocking system of turret rotation;
- Security control on extension chains of boom 1;
- Security control on extension/return chains of boom 2.





All safety devices could wear out and lose their calibration, it is therefore necessary to control and keep them in perfect working order.

Do not rely totally on these devices to assess your working and safety conditions; in any case, the operator must have a proper and conscious use of the machine.

## 5 ▶▶ Markings ◀◀

On the machine there are the following markings.

- ☐☐ Before using the MEWP, it is compulsory to check the presence and the perfect readability of these marks. In case of absence or decay of the marks, contact the Service.

 <b>C.M.C. s.r.l.</b> Via Bitritto, 119 70124 BARI - ITALY Tel. 080 5326606/557 http://www.cmclift.com E-mail: info@cmclift.com				 	
<b>TYPE</b>	<b>S28</b>	<b>MANUFACTURER</b>	<b>CMC</b>		
<b>MODEL</b>	<b>S28</b>	<b>YEAR</b>	<b>2019</b>		
<b>SERIAL NR.</b>		<b>TOT. WEIGHT</b>			
<b>CAPACITY</b>	<b>508 lbs</b>	<b>INCLUDING</b>	<b>2 persons</b>		
<b>MAX HYDRAULIC OPERATING PRESSURE</b>	<b>3336 PSI</b>				
<b>MAX MANUAL HORIZONTAL FORCE ALLOWED</b>	<b>90 lbs</b>				
<b>MAX WIND SPEED ALLOWED</b>	<b>28 mph</b>				
<b>MAX FRAME INCLINATION ALLOWED</b>	<b>1 °</b>				
<b>EXTERNAL POWER SOURCE</b>	<b>120 V</b>	<b>60 Hz</b>			

Picture 63: identification plate (fac-simile).

# CMC X S28

Picture 64: CMC model mark.



Picture 65: max capacity allowed in the basket.

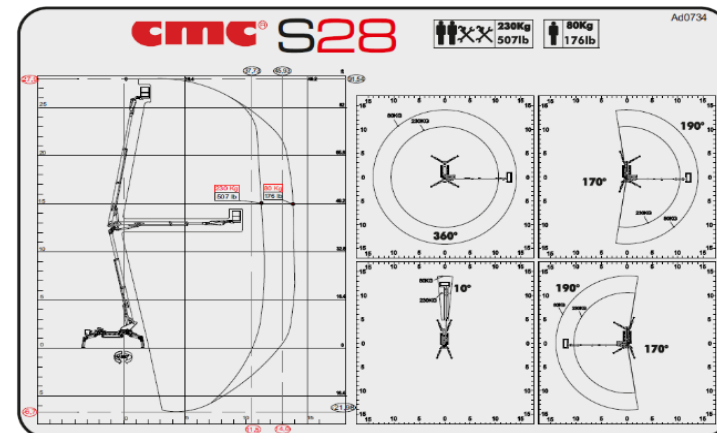

Picture 66: work diagram.

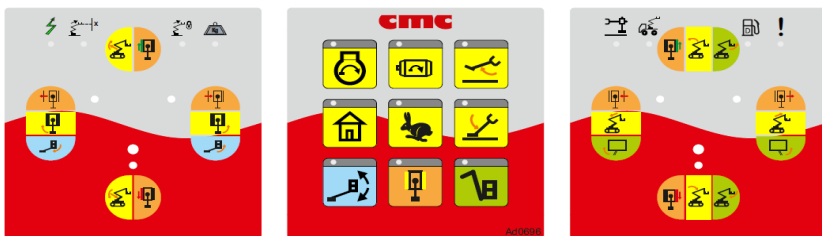

Picture 67: MOBA basket control station (\*optional).

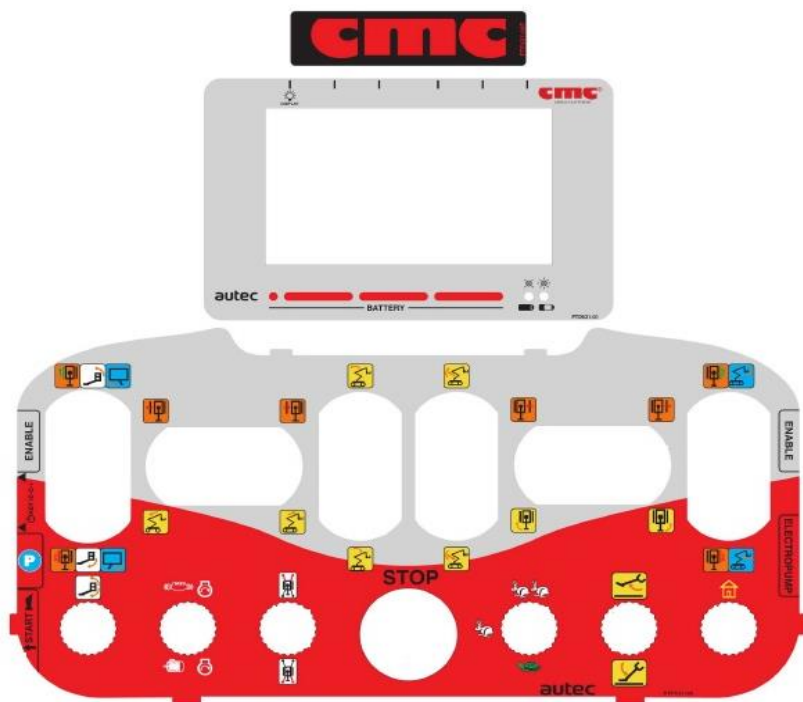

Picture 68: AUTEC radio control.

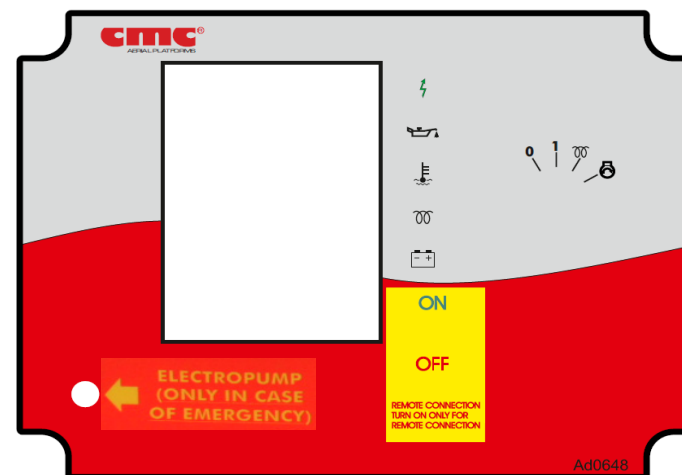

Picture 69: switching on/off box.

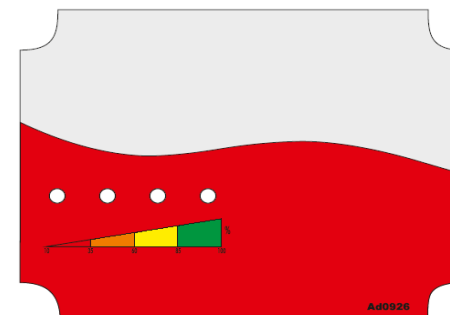

Picture 70: basket box in hybrid version.

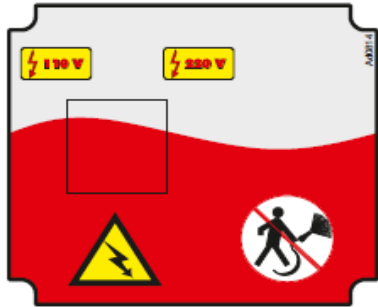

Picture 71: voltage selection box.

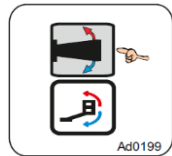

Picture 72: lever for basket leveling.



Picture 73: safety belt attachment point.



Picture 74: indication of air/water supplies.



Picture 75: load cell marking.



Picture 76: indication of 24 V socket.

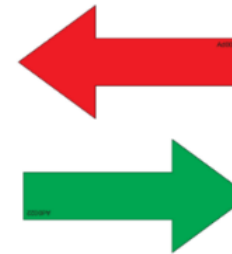

Picture 77: travel directions on tracks.

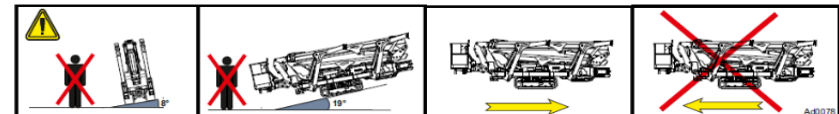

Picture 78: maximum slopes for travel.



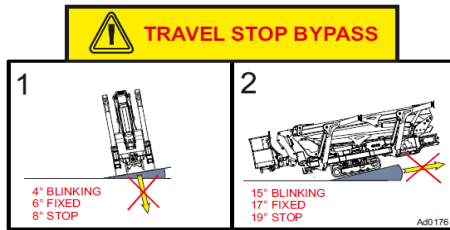

Picture 79: travel bypass box.



Picture 80: lever for travel block bypass.



Picture 81: use and maintenance manual box.

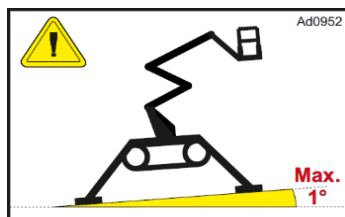

Picture 82: indication of maximum frame inclination.

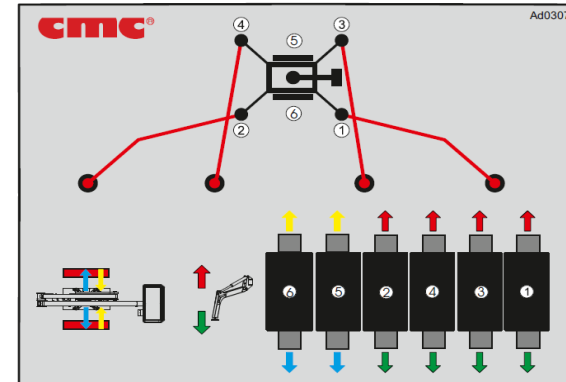

Picture 83: outriggers control station.

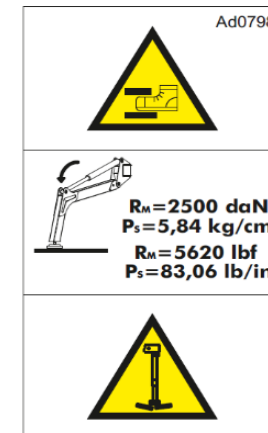

Picture 84 maximum load on stabilizers.



Picture 85: prohibition to stand in work area.



Picture 86: prohibition to remove safety devices.



Picture 87: indication for fuel refill.



Picture 88: exhaust gas hazard.



Picture 89: danger of flammable substances.



Picture 90: indication for grease application.

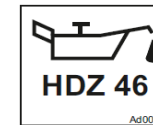

Picture 91: indication for engine oil checking/refill.

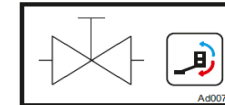

Picture 92: indication of basket levelling valves.



Picture 93: auxiliary electric engines (\*optional).

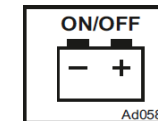

Picture 94: indication for engine battery disconnection.



Picture 95: indication of platform fuse.



Picture 96: indication of frame coupling.



Picture 97: indication of fork points.

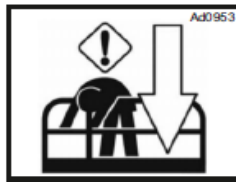

Picture 98: warning for basket operator fainting.



Picture 99: emergency bypass.



Picture 100: indication of emergency manual pump.

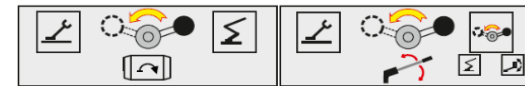
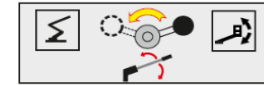

Picture 101: knob for function exchange.

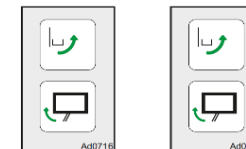

Picture 102: cursors for jib movement and basket rotation.

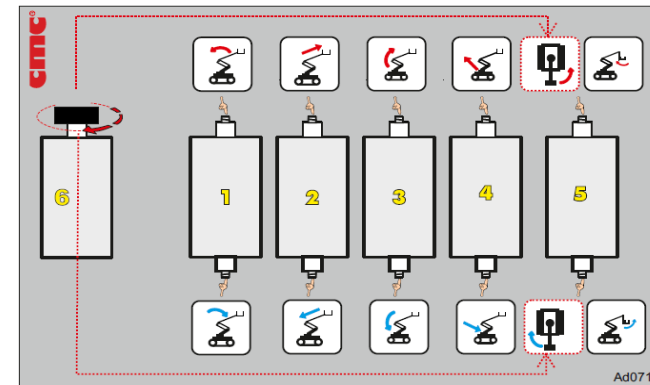

Picture 103: emergency workbench.



Picture 104: general obligations and prohibitions.

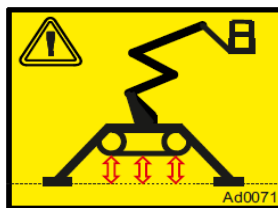

Picture 105: warning for tracks lifting during stabilization.



Picture 106: warning of burn risk.



Picture 107: earthing.



Picture 108: electric danger.



Picture 109: crushing and cutting hazard.



Picture 110: high pressure hazard.



Picture 111: danger of falling.



Picture 112: obstacle danger.



Picture 113: machine sound power.



Picture 114: prohibition to wet the machine.



Picture 115: warning to obligate to the consultation of use and maintenance manual.

**GUIDELINES FOR USE AND MAINTENANCE**

- The use of the MEWP is restricted only to authorized and previously trained personnel.
- Consult and comply strictly with the instructions indicated in **USE AND MAINTENANCE MANUAL** attached to the machine.
- Never exceed the maximum capacity indicated on the basket.
- The use of personal protective equipment is mandatory. In the basket, hook the safety belt to the appropriate anchors.
- Before starting works, the operator must make sure that the mechanical parts and safety devices work properly and efficiently, and check the hydraulic oil and fuel levels.
- Never stabilize the machine on soft, accidental, slippery ground or with slopes higher than the allowed limit.
- Perfectly level the machine frame within the maximum allowed limit.
- All handling maneuvers must be carried out making sure that you have complete visibility of the work area.
- Before activating any movement, check that there are no obstacles or people in the work area.
- Load and unload from the basket only on the ground.
- It is forbidden to carry out works at a distance of less than 5 m from power lines.
- It is forbidden to operate in unfavorable weather conditions.
- It is forbidden to use the machine as a lift for things or people.
- It is forbidden to fix stairs or other equipment to the basket to increase the working height.

Ad0137

Picture 116: MEWP use guidelines.

Ad0020

**NOTICE/AVIS**

THIS AERIAL WORK PLATFORM IS BUILT ACCORDING TO **US, ANSI 92.6 SECTION 4** and **CAN/CSA B354.4-02 (R2013)** about «Self-propelled boom-supported aerial elevating work platforms».

LA PLATE-FORME DE TRAVAIL AÉRIENNE EST FAITE SELON LES NORMES **US ANSI 92.6 SECTION 4** ET **CAN/CSA B354.4-02 (R2013)** «Plate-forme de travail aérienne avec élévation supportée par la flèche auto-propulsées».

Picture 117: compliance with ANSI and CAN/CSA rules.

NEXT INSPECTION DUE ON: \_\_\_\_\_ DATE: \_\_\_\_\_

or WORKING HOURS

**CMC**

Ad0031

Picture 118: inspection tag.

## 6 ►► Electrical system ◀◀

The electrical system is attached to this manual.



Any operation, requiring interventions on the components of the machine, shall be carried out by authorized and trained staff.



It is forbidden to replace the components for non-authorized staff. Many components of the MEWP have been calibrated: a correct calibration of these parts (which is possible only in C.M.C. or in authorized Services) is important to assure the safety of the machine.

- **FUSE BOX (Picture 119):**

At view on machine switching on/off station, there is a fuse box where it is possible to identify all the machine fuses. You can also locate the burnt ones through the lighting of a related spy.



Picture 119: fuse box.

FUSE BOX	
Fuse 1	30 KEY / 30 ENGINE / START
Fuse 2	POWER SUPPLY
Fuse 3	SPARK
Fuse 4	TURRET AND BASKET POWER SUPPLY
Fuse 5	CHASSIS POWER SUPPLY
Fuse 6	CPU ELECTRONIC BOARD POWER SUPPLY
Fuse 7	1554 KEY
Fuse 8	EMERGENCY ELECTROPUMP
Fuse 9	ENGINE THROTTLE + OPTIONAL HYDRATOOL
Fuse 10	STOP ENGINE

Table 3: fuse functions.



## 7 ▶▶ Hydraulic system ◀◀

The MEWP hydraulic system is attached to the manual.



**Attention! The hydraulic circuit is pressurized (max. 1,1 bar at strainer waste).**

The pressure setting of the maximum relief valves must correspond to the following values:

Data	Value	Unit of measure
Double filters workbench	3336 (230)	psi (bar)
Filters group	3191 (220)	psi (bar)
Outriggers workbench	3191 (220)	psi (bar)
Turret workbench	3191 (220)	psi (bar)
Basket workbench	2901 (200)	psi (bar)
Upper boom out	2901 (200)	psi (bar)
Lower boom out	2901 (200)	psi (bar)
Upper boom descent	1885 (130)	psi (bar)
Max. relief valve of frame	2321 (160)	psi (bar)
Max. relief valve of basket distributor	2176 (150)	psi (bar)

A radiator for cooling the hydraulic circuit oil and a biodegradable hydraulic oil can be provided as \*optional. In case of its refill or replacement, it is imperative to comply with the technical specifications of the product already present in the system.



**All the operations requiring the intervention on the components of the machine, shall be carried out by authorized and trained technical staff.**



**Non-authorized staff shall not replace any of the components. Many components have been calibrated: a correct calibration of these parts (possible only in C.M.C. or in authorized Services) is necessary to ensure the safety of the machine.**



## 8 Maintenance

**Working in safety also means working with equipment in accordance with law standards and under constant control.**

Then, the employer must:

- select appropriate equipment, adapted to the environment and working conditions and to the characteristics of the worker who implements it;
- supervise that it is used appropriately, and that specific training is provided to workers;
- ensure that the work equipment is:
  - installed and used in accordance with the use instructions;
  - subject to proper maintenance in order to guarantee the permanence of the safety requirements
  - subject to the update of the minimum safety requirements established with international specific regulations.

A correct use of the platform and a regular maintenance are crucial to keep it always in the best working, efficiency and safety conditions. The frequent washing of the equipment by high-pressure water jet machines is crucial to get rid of the harmful remains coming from the works performed and from atmospheric agents. Before washing, set the MEWP in driving position, stall the engine and take off the batteries.

To document what has been done, the employer is therefore required to draw up and update the appropriate equipment control register.



**Carefully read and scrupulously follow the maintenance instructions and safety laws during the maintenance.**

The operations indicated with **USER** are to be performed by the user. The operations indicated with **C.M.C.** shall be performed only by C.M.C. srl or in authorized repair shops.

Use only C.M.C. original spare parts (even if on the market there are equivalent or similar parts).

The frequency of the maintenances is indicated in every table. It is implied a normal use of the equipment; while, for particularly rough uses or in harmful environments (presence of dust, sand, etc.), an optimal maintenance frequency is left to the good sense of the user.



**If an intervention that is different from the following ones is necessary, ask the Technical Assistance Service for authorization and instructions.**

### 8.1 Daily maintenance

**Every day, before starting the MEWP, perform what follows:**





**All the following checks are to be performed operating the MEWP from the emergency position and without anyone inside the basket.**

Checks by USER	In case of negative result of the checks:	Intervention by:
Check the <b>level of the hydraulic oil</b> in the tank.	Top up	USER
Check <b>the level of the gas-oil</b> in the tank.	Top up	USER
Check <b>the level of the refrigerating liquid.</b>	Top up	USER
Check the <b>batteries charge condition.</b>	Charge or replace	USER
Check the <b>cleanliness of the floor:</b> oily or greasy residues could cause slipping.	Clean	USER
Check the wholeness of the instruction and warning <b>stickers.</b>	Replace and/or integrate	USER











Checks by USER	In case of negative result of the checks:	Intervention by:
<p><b>Perform the following test maneuvers</b> operating on the (emergency) controls of the cabled remote control when no one is aboard:</p> <ul style="list-style-type: none"> <li>○ Lifting and lowering of telescopic boom 1;</li> <li>○ Lifting and lowering of telescopic boom 2;</li> <li>○ Lifting and lowering of the Jib;</li> <li>○ Turret CW and CCW rotation;</li> <li>○ Extension and withdrawal of telescopic booms.</li> </ul>	<p>If the problem can be solved following the instructions given in the paragraph "Trouble shooting", perform the operations indicated in the said paragraph.</p>	USER
<p><b>During the test operations, check that the basket floors stays horizontal.</b></p> <p><b>Check the functioning of the outriggers block valves</b>, with boom not in the rest position:</p> <ul style="list-style-type: none"> <li>○ Extend outriggers and level the MEWP;</li> <li>○ Push the "EMERGENCY" button to stall the engine;</li> <li>○ Operate the lever for the lift and lowering of the outriggers.</li> </ul> <p><b>OUTRIGGERS SHALL NOT MOVE.</b></p>	 <p>If the problem is not solvable following the instructions indicated in the paragraph "Troubleshooting", it is strictly forbidden to use the MEWP. Contact the Service.</p>	C.M.C.

Checks by USER	In case of negative result of the checks:	Intervention by:
<p><b>Check the functioning of the block valves of the boom extension cylinder:</b></p> <ul style="list-style-type: none"> <li>○ Extend the boom and set it vertically;</li> <li>○ Push the "EMERGENCY" button to stall the engine;</li> <li>○ Operate the extension and retraction lever of extension boom.</li> </ul> <p><b>THE BOOM SHALL NOT GET BACK IN.</b></p>	<p>If the problem can be solved following the instructions given in the paragraph "Trouble shooting", perform the operations indicated in the said paragraph.</p>	USER
<p><b>Check the functioning of the block valves of the boom lifting cylinder:</b></p> <ul style="list-style-type: none"> <li>○ Load the basket with 230 kg (only weights).</li> </ul>  <p>During the test, it is strictly forbidden to load the MEWP with people in the basket.</p> <ul style="list-style-type: none"> <li>○ Extend the telescopic boom;</li> <li>○ Push the "EMERGENCY" button to stall the engine;</li> <li>○ Operate the lifting and lowering lever of the telescopic boom.</li> </ul> <p><b>THE TELESCOPIC BOOM SHALL NOT MOVE.</b></p>	 <p>If the problem is not solvable following the instructions indicated in the paragraph "Troubleshooting", it is strictly forbidden to use the MEWP. Contact the Service.</p>	C.M.C.



Checks by USER	In case of negative result of the checks:	Intervention by:
Check the <b>absence of splits, cracks, rust</b> on the MEWP structure.	 It is strictly forbidden to use the MEWP. Contact the Service.	C.M.C.
<b>Check that the safety devices</b> (emergency buttons, interlock system for outriggers-boom) <b>work perfectly.</b>	 It is strictly forbidden to use the MEWP. Contact the Service.	C.M.C.
Check that <b>the controls, the pilot lights, the emergency buttons work perfectly.</b>	 It is strictly forbidden to use the MEWP. Contact the Service.	C.M.C.
Check the wholeness of the <b>cable chains.</b>	 It is strictly forbidden to use the MEWP. Contact the Service.	C.M.C.
Check that the <b>blocking systems</b> (pins, locknut, etc.) are in perfect condition and efficient.	 It is strictly forbidden to use the MEWP. Contact the Service.	C.M.C.

Checks by USER	In case of negative result of the checks:	Intervention by:
Check <b>the wholeness of the flexible pipes, of the pipe fitting and the components of the hydraulic circuit:</b> check that there is no oil leakage in hydraulic circuit.	Replacement	USER / C.M.C.
Check that the <b>electrical contacts</b> are not slacken.	Reset connections	USER / C.M.C.
Check that there is no <b>trace of clashes</b> on the equipment.	 It is strictly forbidden to use the MEWP. Contact the Service.	C.M.C.

## 8.2 ► Weekly maintenance (or every 40 hours) ◀

Operations	by
Check the <b>absence of splits, cracks, rust</b> on the MEWP counter frame (use torches or lamps to inspect the internal part under the floor).	USER / C.M.C.
Check the <b>cleanliness</b> of the chassis engine and auxiliary motor* <b>air filter.</b>	USER / C.M.C.
Check the <b>cleanliness of the hydraulic filters.</b>	USER / C.M.C.



### 8.3 ▶ Monthly maintenance (or every 120 hours) ◀

Operations	by
Greasing of pins and movable parts.	USER / C.M.C.
Washing of the equipment.	USER / C.M.C.
Check the <b>tightening of the bolts of the bearing, the geared motor and the frame.</b>	USER / C.M.C.

### 8.4 ▶ Quarterly maintenance (or every 300 hours) ◀

Operations	by
Check the <b>tightening of the bolts of the bearing, the geared motor and the frame.</b>	USER / C.M.C.

### 8.5 ▶ Maintenance after the first 400 hours ◀

Operations	by
Replacement of the <b>hydraulic filters.</b>	USER / C.M.C.
Registration of the movement of the booms.	C.M.C.

### 8.6 ▶ Six-monthly maintenance (or every 750 hours) ◀

Operations	by
Replacement of the <b>hydraulic filters</b> (25 micron).	USER / C.M.C.
<b>Complete check of the whole machine</b> and note the results in the appropriate manual section.	USER / C.M.C.

### 8.7 ▶ Annual maintenance (or every 1500 hours) ◀

Operations	by
Replacement of <b>hydraulic oil.</b>	C.M.C.

For the replacement of the hydraulic oil, follow these instructions:

1. Place the machine in transport position on a plane ground;
2. Open the filter tap by a key;
3. Suck in the oil from the tank;
4. Dismantle and replace the old hydraulic filter with a new one with a 25 micron filtration degree;
5. Fill the tank with the new oil until the maximum level indicator.



**Attention! The hydraulic circuit is pressurized (max. 1,1 bar at strainer waste).**

### 8.8 ▶ Biennial maintenance ◀

Operations	by
<b>Complete check of the whole machine</b> and note the results in the appropriate manual section.	C.M.C.

### 8.9 ▶ Five-yearly maintenance ◀

Operations	by
<b>Complete check of the whole machine</b> and note the results in the appropriate manual section.	C.M.C.



## 8.10 ▶ Safety rules during maintenance ◀



**THE NON-OBSERVANCE OF ONE OF THE FOLLOWING SAFETY RULES CAN SERIOUSLY HARM PEOPLE OR CAUSE SEVERE DAMAGES TO THINGS OR PARTS OF THE EQUIPMENT OR OF THE VEHICLE.**

- ➔ To ensure the safety of the machine **the use of original spare parts installed by C.M.C. or by authorized repair shops is compulsory:** in fact, some components can be calibrated only c/or C.M.C. or in authorized workshops.



**It is forbidden to perform maintenance operations when the MEWP moves:** make sure that the parts to maintain are motionless and do these operations with the motor of the chassis stalled, taking the keys away from the panel;

- ➔ Perform the maintenance operations in a sufficiently large space and suited to the sizes of the truck: mark the area assigned for the maintenance operations by suited enclosure or by a red/white band ribbon and do not allow entrance to unauthorized staff.
- ➔ Do not modify or remove safety devices.
- ➔ Do not modify calibrated pieces.
- ➔ During the washing operation, do not lead the water jet directly on the electrical panels of the MEWP and do not use cleansing, aggressive chemicals dangerous for the components of the MEWP (rubber parts, painted parts, etc.).



**It is forbidden to perform any intervention on parts of the MEWP, such as welding, piercing, and so on, without prior written authorization by C.M.C.**

- ➔ Wear appropriate protective clothes (gloves, goggles, etc.).
- ➔ During maintenance operations, be careful not to damage the hydraulic circuit and avoid impurities in the circuit.

- ➔ Before any maintenance operation that involves the disassembly of hydraulic circuit parts, make sure that the system is not under pressure. In order to avoid violent emissions of oil, move all the levers of the control distributors, with the truck motor stalled and no component in movement.

## 8.11 ▶ Maintenance of endothermic engine ◀

The standard supplied motor has the following technical characteristics:

- *Diesel engine KUBOTA D902-E4B* (3 cylinders, four-stroke vertical heated to water):

Data	Value	Unit of measure
Cylinder capacity	0.898	l
Highest performance at 3200 RPM	16.1 21.6	kW HP
Minimum number of RPM	900-1000	RPM
Dry weight	158.73	lbs.
Starter motor power (12 V)	1.2	kW
Alternator power (12 V)	480	W

## 8.12 ▶ Maintenance of 48 V electric engine (\*optional) ◀

The 48 V electric engine with battery pack, provided as optional\* in full lithium version, has the following technical characteristics:



Battery specifics		
Battery Composition	LiFePo4	
Typical Capacity	200	[Ah]
Cells Configuration	15S1P	
Rated Voltage	48	[V]
Maximum Voltage Fully Charge	54.8	[V]
Minimum Operative Voltage	42	[V]
Rated Discharge Current	30	[A]
Maximum Discharge Current	100 (electronically limited)	[A]
Rated Charge Current	30 A (0.3 C)	
DoD	80	[%]
Battery Life Cycle	>2000 Cycle@80%DoD or >3000 Cycle@70%DoD	
Operative temperature (during charge)	-20/+60*	[°C]
Operative temperature (during discharge)	-20/+60	[°C]
Battery Weight	70 approximately	[kg]
Maximum Output Power	4.8	[kW]
Rated Energy	4.32	[kWh]

\*When charge is operated at less than 0°C the charge current is electronically limited at 10 A.

Battery charger specifics		
Voltage Input	100 - 240	Vac
Frequency Input	50 - 60	Hz
Maximum Output Voltage	>=60	V
Maximum Current	22	A
PWM Frequency	1	kHz
International Protection	IP20	
Weight	2,2	Kg
Dimension (L*W*H)	180x310x100	mm

## 8.13 ► Consumables for maintenance ◀

### Hydraulic oil:

Gazpromneft Hydraulic	HDZ ISO	32	46
Density, 15 °C, kg/l	ASTM D1298	0,867	0,872
Kinematic Viscosity, 40 °C, mm2/s	ASTM D445	32	46
Kinematic Viscosity, 100 °C, mm2/s	ASTM D445	6,32	8,03
Viscosity Index	ASTM D2270	151	154
Pour Point, °C	ASTM D97	-42	-42
Flash Point COC, °C	ASTM D92	204	216
Air release, 50 °C, min	ISO DIS 9120	5	6
Copper corrosion, 3 hrs, 100°C	ASTM D130	1a	1a
FZG, Damaged Load, A/8,3/90	DIN 51354	12	12

(hydraulic tank capacity: 50 lt)

### Grease:

- for boom extension and outriggers:  
**Interflon Grease LS1/2**  
Composition: mixture of mineral oils, calcium-lithium complex thickener, additives and Teflon®.  
(working field: from -20°C to +120°C)
- for lubricators and bearing:  
**WHITE STAR NLGI 0 E 2**  
Composition: mixture of mineral oils and additives.  
(working field: from -30°C to +110°C)
- for chains:  
**Interflon LUBE EP+**  
Composition: mixture of mineral and vegetable oils, additives and Teflon®.  
Density, 20°C: 0,89 g/cm3  
Kinematic viscosity, 20°C (ASTM D2983): 380 mPa.



-  Before oil replacement, place an oil drip tray in order to avoid the leakage of oil in the environment. Do not disperse the exhausted oil or other consumables in the environment; put them in the appropriate containers and give them to the authorized collection centers.

### 8.14 ▶ Indications for the demolition of the MEWP ◀



In case of demolition, the machine must be dismantled completely according to the laws in force.

-  The different types of materials must be destined to the respective authorized centers of collection.

The following material must undergo differentiated disposal therefore placed in suitable places and containers:

- Ferrous materials: carpentries and mechanical components.
- Plastic materials: gaskets, straps, and protections.
- Electrical materials: windings, controls, electro valves and similar.
- Oils and lubricants: hydraulic oil, reducer lubricants, and lubricants greases.

### 8.15 ▶ Service ◀

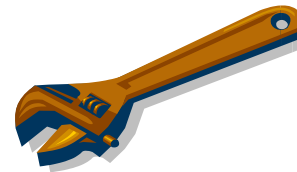

For repairs and maintenance of your platform, refer exclusively to:

**Service**  
**C.M.C. s.r.l.**  
 Via Bitritto, 119  
 70124 BARI – ITALY  
 Tel. **+39 080 5326606**  
**+39 080 5326557**  
 Fax: **+39 080 5368541**  
 E-mail: [info@cmclift.com](mailto:info@cmclift.com)

 PLEASE NOTICE:

FOR ANY COMMUNICATION, PLEASE SPECIFY MODEL AND SERIAL NUMBER OF THE MEWP.



**Any operation requiring interventions on the components of the machine shall be carried out by authorized and trained staff.**



**Non-authorized staff cannot replace components.** Many components of the MEWP have been calibrated: a correct calibration of these parts (which is possible only in C.M.C. or in authorized repair shops) is necessary to ensure the safety of the machine.



### 8.15.1 ▶ Remote Connection System (\*optional)

The remote connection system is composed of an electronic box (Picture 120) mounted on the chassis box.



Picture 120: remote connection system.

Following the remote connection procedure:

1. Ensure that the M12 socket on the remote connection box is correctly connected to the M12 plug of the electric box mounted on the chassis;
2. Share your internet wireless network with the remote connection device in free mode (without password);
3. Lift the connection remote switch **L** on the switching on/off box (Picture 121):



Picture 121: chassis box.

- the led on the remote connection box makes two red flashes,
  - after 30 seconds, the led becomes fixed and green, to show that the operating system is working,
  - it automatically hooks up to your free network;
4. Install on your PC the TeamViewer software (11<sup>th</sup> version) to connect to the machine system, through ID and Password supplied by the manufacturer;
  5. Call C.M.C. Service for technical assistance.



## 9 Troubleshooting



**Any operation requiring interventions on the components of the machine, shall be carried out by authorized and trained staff.**



**Non-authorized staff is not allowed to replace components. Many components of the MEWP have been calibrated: a correct calibration of these parts (which is possible only in C.M.C. or in authorized repair shops) is necessary to assure the safety of the machine.**

Issue: THE CONSENT LIGHT FOR STABILIZATION DOES NOT TURN ON.

- Causes:
1. The aerial part of the MEWP is not in transport position.
  2. Failure fuse 30A battery side.
  3. Defective board.
  4. Wire removed from the battery.

- Remedies:
1. Place the aerial part of the MEWP in transport position.
  2. Check if any cable is disconnected from the battery.
  3. Replace fuse.
  4. Replace the limit switches.

If the problem persists, contact the Service.

Issue: THE STABILIZERS DO NOT WORK.

- Causes:
1. The hydraulic pump unit is faulty.
  2. Stabilizers electrovalve do not work.

- Remedies:
1. Replace the hydraulic pump.
  2. Replace the stabilizers limit switches.

If the problem persists, contact the Service.

Issue: WITH THE MEWP STABILIZED, THE CONSENT LIGHT FOR AERIAL PART USE DOES NOT TURN ON.

- Cause:
1. The green light does not work.
  2. Micro-switch system does not work.
  3. Stabilization is incomplete.

- Remedies:
1. Replace led.
  2. Replace micro-switch.
  3. Further extract outriggers up to soil contact.

If the problem persists, contact the Service.

Issue: THE AERIAL PART OF THE MEWP DOES NOT WORK.

- Causes:
1. The hydraulic pump unit is faulty.
  2. Not having switched the deadman lever on control station.
  3. The exchange electrovalve is not energized.
  4. Emergency button activated.

- Remedies:
1. Replace the hydraulic pump.
  2. Turn on and connect the control station.
  3. Replace the exchange valve.
  4. Turn the emergency button and reset the MEWP.

If the problem persists, contact the Service.

Issue: THE BASKET LEVELLING DOES NOT WORK.

- Causes:
1. Oil leakage.
  2. Cylinder seals worn.

- Remedies:
1. Tighten the hydraulic connections.
  2. Replace the seals.

If the problem persists, contact the Service.





---

Issue: LOW MANOEUVRES SPEED.

- Causes:
1. Pump failure.
  2. Hydraulic oil level too low.
  3. Oil filter clogged.

- Remedies:
1. Replace the hydraulic pump.
  2. Refill hydraulic oil.
  3. Replace the filter.

If the problem persists, contact the Service.

---

Issue: IMPOSSIBLE TO START THE ENDOTHERMIC ENGINE.

- Causes:
1. Emergency activated.
  2. Battery discharged.
  3. Out of fuel.
  4. Hydraulic oil level too low.

- Remedies:
1. Disable the emergency button.
  2. Replace the battery.
  3. Refuel.
  4. Refill hydraulic oil.

If the problem persists, contact the Service.

---

The display on the radio control (par. 3.2.2.1) allows to read the machine operational conditions as well as to detect possible functional anomalies. Reading the corresponding possible error code and contacting our Service Centre, it is possible – at any moment – to detect and solve the problem.



**Contact our Service Centre for any technical problem which is not identified nor solved by the aforesaid procedure.**



## 10 ►► Sealings list ◀◀

For your information, hereby there is a list of the anti-tampering sealings present on the MEWP:

- Emergency bypass;
- Block travel bypass;
- Outriggers monitored electrovalve;
- MEWP valve;
- Proportional valves for aerial part and outriggers.

 **The tampering or replacement of components by non-authorized staff is strictly forbidden.**

**→ It is mandatory to restore the sealings after use of these items.**



## 11 ▶▶ Overload tests ◀◀



During the commissioning of the machine, in the final test, we carried out the following overload tests. During the same, we tested S28 stability and structural resistance.



Overload tests shall be carried out only on the first test of the machine: these tests are unique. In no other occasion shall you carry out tests with the same loads used in the overload tests.

Overload						
Test n°	Load (Kg)	Booms position			Movement	Notes
		Ray (m)	Boom 2	Boom 1		
1	230 (PN) + 203 (CP)	10,50	Horizontal	Completely retracted	Lateral left	OK
2	80 (PN) + 147 (CP)	13,00	Horizontal	Completely retracted	Lateral left	OK

**NOTES.**

PN: nominal flow rate.

CP: test load.



## 12 ▶▶ Operating tests ◀◀



During the commissioning of the machine, we carried out the following final operation tests. We have tested the correct operation of the S28 and of its safety systems.

Test description	Outcome
▪ Block of the operation in case of release of the selected operation lever.	OK
▪ Basket levelling allowed only when the MEWP aerial part is set in the rest position (pantograph on its support and telescopic boom on its support).	OK
▪ Manual pump for operations in case of emergency.	OK
▪ Outriggers-boom operation interlock.	OK
▪ MEWP aerial part operations block when the MEWP is not stabilized	OK
▪ Block of the return/extension of outriggers when the MEWP aerial part is not set in the rest position.	OK
▪ Stabilized machine – signal light.	OK
▪ MEWP electrical power – signal light.	OK
▪ Outriggers returned – signal light.	OK
▪ Chassis maximum inclination detector.	OK
▪ Rotating blinker (*optional).	OK
▪ Emergency buttons in the control stations.	OK
▪ Lock valves on cylinders.	OK
▪ Max pressure valve for the protection of the whole hydraulic circuit.	OK
▪ Max pressure valves for the protection of the single parts of the system.	OK

▪ Electrical system protection fuse.	OK
▪ Moment limiting device.	OK
▪ Load limiting device.	OK



## 13 ▶▶ Control register ◀◀

In this register note down the following events in the machine life:

- Delivery of the MEWP to the first owner (par. 13.1)
- Following ownership transfers (par. 13.2)
- Replacement of mechanisms (par. 13.3)
- Replacement of structural elements (par. 13.4)
- Replacement of hydraulic components (par. 13.5)
- Replacement of electrical components (par. 13.6)
- Replacement of safety devices (par. 13.7)
- Considerable failures and relevant repairs (par. 13.8)
- Periodical checks and maintenance journal (par. 13.9)
- Notes (par. 13.10)

### 13.1 ▶ Delivery of the MEWP to the first owner ◀



The mobile elevating work platform  
brand **C.M.C.**  
model **S28**  
serial number  
manufacture year **2020**

has been delivered by **C.M.C. s.r.l.**

to the firm  
0  
0

according to the contractual conditions  
established with the technical, dimensional and  
functional features indicated in the  
use and maintenance manual.

Date \_\_\_\_\_

C.M.C. s.r.l.  
\_\_\_\_\_



**13.2 ▶ Following ownership transfers ◀**

On the ..... the ownership of the MEWP in subject is transferred to the firm/company .....

It is certified that, on the above date, the functional, dimensional and technical features of the MEWP in subject are in keeping with those foreseen at the beginning and that further changes have been written on this register.

The seller

The buyer

On the ..... the ownership of the MEWP in subject is transferred to the firm/company .....

It is certified that, on the above date, the functional, dimensional and technical features of the MEWP in subject are in keeping with those foreseen at the beginning and that further changes have been written on this register.

The seller

The buyer

On the ..... the ownership of the MEWP in subject is transferred to the firm/company .....

It is certified that, on the above date, the functional, dimensional and technical features of the MEWP in subject are in keeping with those foreseen at the beginning and that further changes have been written on this register.

The seller

The buyer

On the ..... the ownership of the MEWP in subject is transferred to the firm/company .....

It is certified that, on the above date, the functional, dimensional and technical features of the MEWP in subject are in keeping with those foreseen at the beginning and that further changes have been written on this register.

The seller

The buyer



**13.3 ▶ Replacement of mechanisms** ◀

Description of the component: .....

Manufacturer: .....

Provided by .....

Cause of the replacement: .....

.....

Place ..... Date .....

Stamp and signature of the responsible  
for the firm in charge

The user

Description of the component: .....

Manufacturer: .....

Provided by .....

Cause of the replacement: .....

.....

Place ..... Date .....

Stamp and signature of the responsible  
for the firm in charge

The user

Description of the component: .....

Manufacturer: .....

Provided by .....

Cause of the replacement: .....

.....

Place ..... Date .....

Stamp and signature of the responsible  
for the firm in charge

The user

Description of the component: .....

Manufacturer: .....

Provided by .....

Cause of the replacement: .....

.....

Place ..... Date .....

Stamp and signature of the responsible  
for the firm in charge

The user



**13.4 ▶ Replacement of structural elements ◀**

Description of the component: .....

Manufacturer: .....

Provided by .....

Cause of the replacement: .....

.....

Place ..... Date .....

Stamp and signature of the responsible  
for the firm in charge The user

Description of the component: .....

Manufacturer: .....

Provided by .....

Cause of the replacement: .....

.....

Place ..... Date .....

Stamp and signature of the responsible  
for the firm in charge The user

Description of the component: .....

Manufacturer: .....

Provided by .....

Cause of the replacement: .....

.....

Place ..... Date .....

Stamp and signature of the responsible  
for the firm in charge The user

Description of the component: .....

Manufacturer: .....

Provided by .....

Cause of the replacement: .....

.....

Place ..... Date .....

Stamp and signature of the responsible  
for the firm in charge The user





**13.5 ▶ Replacement of hydraulic components ◀**

Description of the component: .....

Manufacturer: .....

Provided by .....

Cause of the replacement: .....

.....

Place ..... Date .....

Stamp and signature of the responsible  
for the firm in charge The user

Description of the component: .....

Manufacturer: .....

Provided by .....

Cause of the replacement: .....

.....

Place ..... Date .....

Stamp and signature of the responsible  
for the firm in charge The user

Description of the component: .....

Manufacturer: .....

Provided by .....

Cause of the replacement: .....

.....

Place ..... Date .....

Stamp and signature of the responsible  
for the firm in charge The user

Description of the component: .....

Manufacturer: .....

Provided by .....

Cause of the replacement: .....

.....

Place ..... Date .....

Stamp and signature of the responsible  
for the firm in charge The user



**13.6 ▶ Replacement of electrical components ◀**

Description of the component: .....

Manufacturer: .....

Provided by .....

Cause of the replacement: .....

.....

Place ..... Date .....

Stamp and signature of the responsible  
for the firm in charge The user

Description of the component: .....

Manufacturer: .....

Provided by .....

Cause of the replacement: .....

.....

Place ..... Date .....

Stamp and signature of the responsible  
for the firm in charge The user

Description of the component: .....

Manufacturer: .....

Provided by .....

Cause of the replacement: .....

.....

Place ..... Date .....

Stamp and signature of the responsible  
for the firm in charge The user

Description of the component: .....

Manufacturer: .....

Provided by .....

Cause of the replacement: .....

.....

Place ..... Date .....

Stamp and signature of the responsible  
for the firm in charge The user



**13.7 ▶ Replacement of safety devices ◀**

Description of the component: .....

Manufacturer: .....

Provided by .....

Cause of the replacement: .....

.....

Place ..... Date .....

Stamp and signature of the responsible  
for the firm in charge The user

Description of the component: .....

Manufacturer: .....

Provided by .....

Cause of the replacement: .....

.....

Place ..... Date .....

Stamp and signature of the responsible  
for the firm in charge The user

Description of the component: .....

Manufacturer: .....

Provided by .....

Cause of the replacement: .....

.....

Place ..... Date .....

Stamp and signature of the responsible  
for the firm in charge The user

Description of the component: .....

Manufacturer: .....

Provided by .....

Cause of the replacement: .....

.....

Place ..... Date .....

Stamp and signature of the responsible  
for the firm in charge The user



**13.8 ▶ Considerable failures and relevant repairs ◀**

Description of the failure: .....

.....  
.....

Cause: .....

.....  
.....

Repairs performed: .....

.....  
.....

Place.....

Date.....

Stamp and signature of the responsible  
for the firm in charge

The user

Description of the failure: .....

.....  
.....

Cause: .....

.....  
.....

Repairs performed: .....

.....  
.....

Place.....

Date.....

Stamp and signature of the responsible  
for the firm in charge

The user



**13.9 ▶ Periodical checks and maintenance journal ◀**

➔ The user shall observe the maintenance and control program described in this manual.

DATE	SERVICE	SIGNATURE

DATE	SERVICE	SIGNATURE



DATE	SERVICE	SIGNATURE

DATE	SERVICE	SIGNATURE



13.10 ▶ Notes



A series of horizontal dotted lines for taking notes, located on the left side of the page.

A series of horizontal dotted lines for taking notes, located on the right side of the page.



## ▶▶ Index ◀◀

0	▶▶ Introduction	◀◀ 1
0.1	▶ Content of the manual	◀ 1
0.2	▶ Disclaimer	◀ 2
0.3	▶ Where and how to store the manual	◀ 2
0.4	▶ Legislative references	◀ 2
0.5	▶ Changes and integrations	◀ 3
1	▶▶ Specifications	◀◀ 4
1.1	▶ Technical sheet	◀ 4
1.2	▶ Identification plate	◀ 6
1.3	▶ CE certification	◀ 7
1.4	▶ TÜV certification	◀ 7
1.5	▶ Classification	◀ 7
1.6	▶ Loading cycles	◀ 7
1.7	▶ Working diagram	◀ 8
2	▶▶ Description and purpose	◀◀ 9
2.1	▶ Machine definition	◀ 9
2.2	▶ Machine purpose	◀ 9
2.3	▶ Description of the main components	◀ 10
3	▶▶ Control stations	◀◀ 12
3.1	▶ Machine switching on/off station	◀ 12
3.2	▶ Platform control stations	◀ 14
3.3	▶ Emergency control stations	◀ 27
4	▶▶ Use procedures	◀◀ 29
4.1	▶ Environmental operational conditions	◀ 29
4.2	▶ Safety distances	◀ 30
4.3	▶ Transport, storage and packing	◀ 30
4.4	▶ MEWP use procedures	◀ 34
4.1	▶ Lithium battery pack recharge (*optional)	◀ 41
4.2	▶ Emergency operations	◀ 42
4.3	▶ Safety rules	◀ 48
4.4	▶ Safety devices	◀ 52
5	▶▶ Markings	◀◀ 53
6	▶▶ Electrical system	◀◀ 61

7	▶▶ Hydraulic system	◀◀ 62
8	▶▶ Maintenance	◀◀ 63
8.1	▶ Daily maintenance	◀ 63
8.2	▶ Weekly maintenance (or every 40 hours)	◀ 65
8.3	▶ Monthly maintenance (or every 120 hours)	◀ 66
8.4	▶ Quarterly maintenance (or every 300 hours)	◀ 66
8.5	▶ Maintenance after the first 400 hours	◀ 66
8.6	▶ Six-monthly maintenance (or every 750 hours)	◀ 66
8.7	▶ Annual maintenance (or every 1500 hours)	◀ 66
8.8	▶ Biennial maintenance	◀ 66
8.9	▶ Five-yearly maintenance	◀ 66
8.10	▶ Safety rules during maintenance	◀ 67
8.11	▶ Maintenance of endothermic engine	◀ 67
8.12	▶ Maintenance of 48 V electric engine (*optional)	◀ 67
8.13	▶ Consumables for maintenance	◀ 68
8.14	▶ Indications for the demolition of the MEWP	◀ 69
8.15	▶ Service	◀ 69
9	▶▶ Troubleshooting	◀◀ 71
10	▶▶ Sealings list	◀◀ 73
11	▶▶ Overload tests	◀◀ 74
12	▶▶ Operating tests	◀◀ 75
13	▶▶ Control register	◀◀ 76
13.1	▶ Delivery of the MEWP to the first owner	◀ 76
13.2	▶ Following ownership transfers	◀ 77
13.3	▶ Replacement of mechanisms	◀ 78
13.4	▶ Replacement of structural elements	◀ 79
13.5	▶ Replacement of hydraulic components	◀ 80
13.6	▶ Replacement of electrical components	◀ 81
13.7	▶ Replacement of safety devices	◀ 82
13.8	▶ Considerable failures and relevant repairs	◀ 83
13.9	▶ Periodical checks and maintenance journal	◀ 84
13.10	▶ Notes	◀ 86