

**MRT 3050 PRIVILEGE PLUS**

Created on 2 April 2021 at 10:01:31 UTC

Technical sheet :

# **MRT 3050 PRIVILEGE PLUS**





Capacities		Metric
Max. capacity	Q	4999 kg
Max. lifting height	h3	29.5 m
Max. Reach	l4	25.8 m
Weight and dimensions		
Overall width	b1	2.49 m
Overall height	h17	3.05 m
Overall cab width	b4	0.99 m
Outer frame turning radius	Wa3	4.9 m
Ground clearance	m4	0.35 m
Wheelbase	y	3.25 m
Tilt-up angle	a4	12 °
Tilt-down angle	a5	108 °
Turret rotation		360 °
Overall weight		21810 kg
Forks length / width / section	l / e / s	1200 mm x45 mm x 130 mm
Wheels		
Tyres type		Pneumatic
Standard tyres		445/65 R22,5
Drive wheels (front / rear)		2 / 2
Steering mode		2 wheel steer, 4 wheel steer, Crab mode
Stabilisers		
Stabs Type		Telescopic Duplex
Controls with stabs		Stabs Commands Individual or Simultaneous
Engine		
Engine brand		Mercedes
Engine norm		Stage IV / Tier 4 Final
Engine model		OM 934 LA.E4-3
I.C. Engine power rating / Power (kW)		176 Hp / 129 kW
Max. torque / Engine rotation (min) / Engine rotation		750 Nm @ 1200 rpm - 1600 rpm
Number of cylinders - Capacity of cylinders		4 - 5130 cm³
Injection		engine Injection direct
Engine cooling system		Water
Number of batteries / Battery / Batteries capacity		2 x 12 V / 120 Ah
Transmission		
Transmission type		Hydrostatic
Number of gears (forward / reverse)		2 / 2
Max. travel speed		40 km/h
Drawbar pull (Laden)		9500 daN
Parking brake		Automatic Negative Hand-brake
Service brake		Hydraulic
Hydraulics		
Hydraulic pump type		Variable pump
Hydraulic flow		180 l/min
Hydraulic Pressure		350 Bar
Tank capacities		
Engine oil		21 l
Hydraulic oil		290 l
Fuel tank		290 l
Diesel Exhaust fluid (AdBlue® type)		57 l
Noise and vibration		
Noise at driving position (LpA)		79.7 dB(A)
Environmental noise (LwA)		108 dB(A)
Vibration to whole hand/arm		< 2.50 m/s²
Miscellaneous		
Steering wheels (front / rear)		2 / 2
Controls		2 Joysticks
Safety cab homologation		ROPS - FOPS cab (level 2)
Attachment recognition system (E-Reco)		Standard

## Dimensional drawing

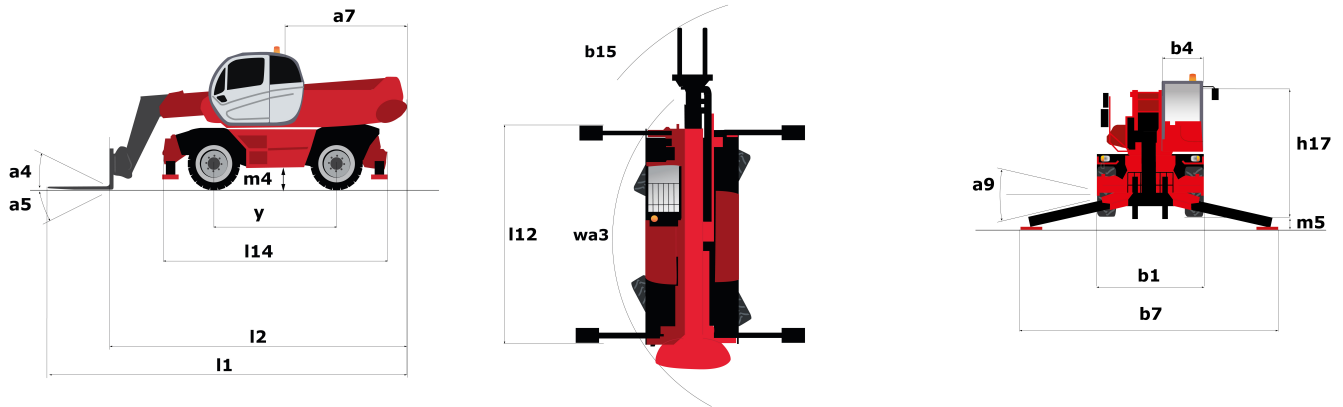

Other data		Metric
Overall length (with forks)	l1	9.02 m
Length to face of forks	l2	7.82 m
Length of frame	l14	5.62 m
Wheelbase	y	3.25 m
Ground clearance	m4	0.35 m
Counterweight offset (turret at 90°)	a7	3.42 m
Tilt-up angle	a4	12 °
Tilt-down angle	a5	108 °
Overall length at stabilisers	l12	5.62 m
Outer frame turning radius	wa3	4.9 m
Outer turning radius (with forks)	b15	6.49 m
Overall width	b1	2.49 m
Overall width with stabilisers extended	b7	6.06 m
Overall cab width	b4	0.99 m
Overall height	h17	3.05 m
Frame levelling corrector	a9	+/- 7.4 °
Ground clearance under front tires on stabilizers	m5	0.32 m

## Load chart

Machine on lowered stabilisers with forks Metric

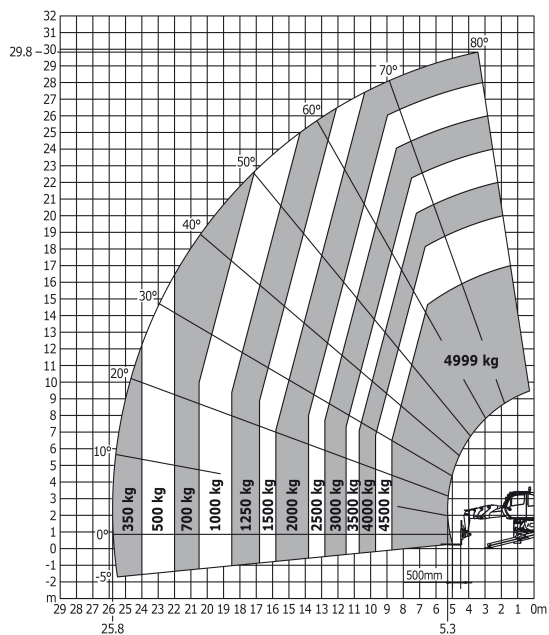

Machine on lowered stabilisers with winch 5000 kg Metric

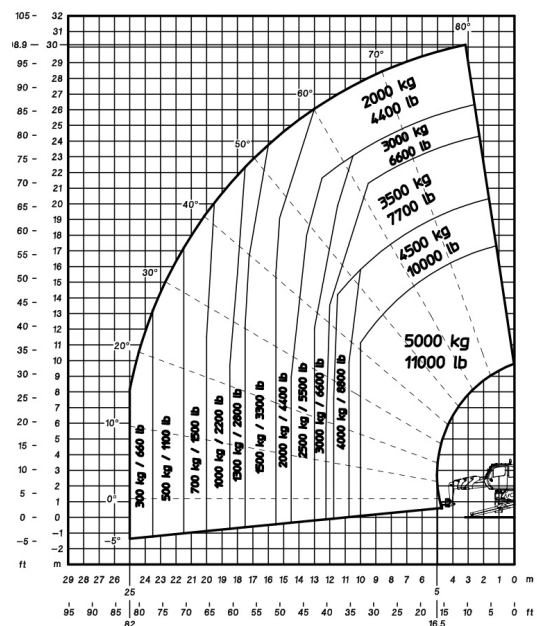

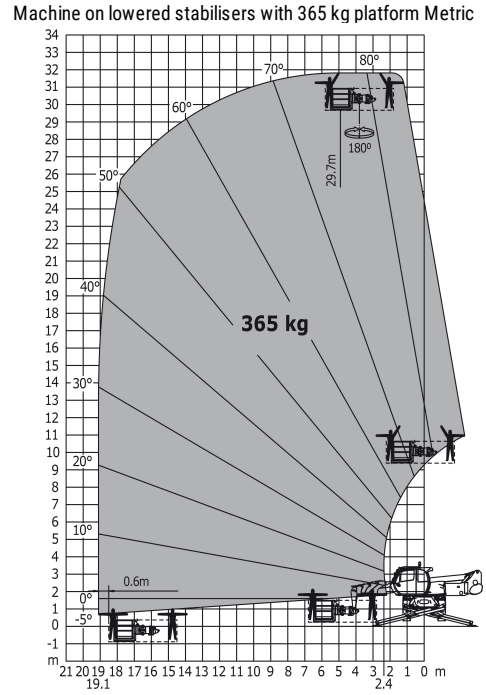
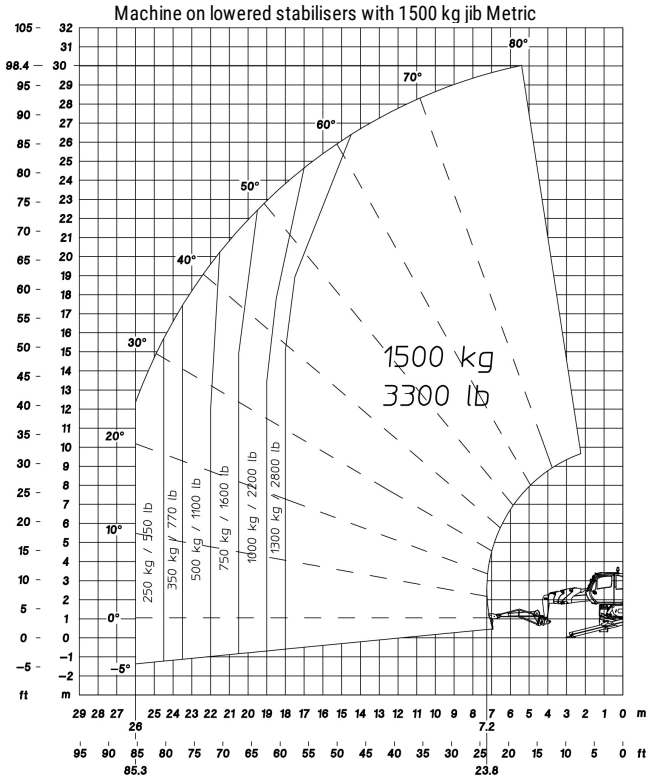

**Machine on lowered stabilisers with 1000 kg platform Metric**

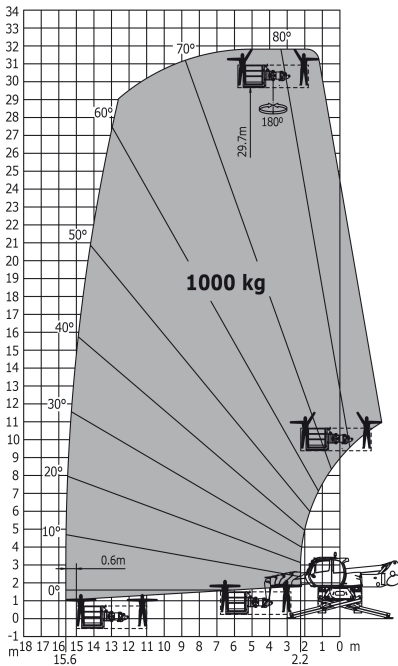

**Machine on tyres with forks Metric**

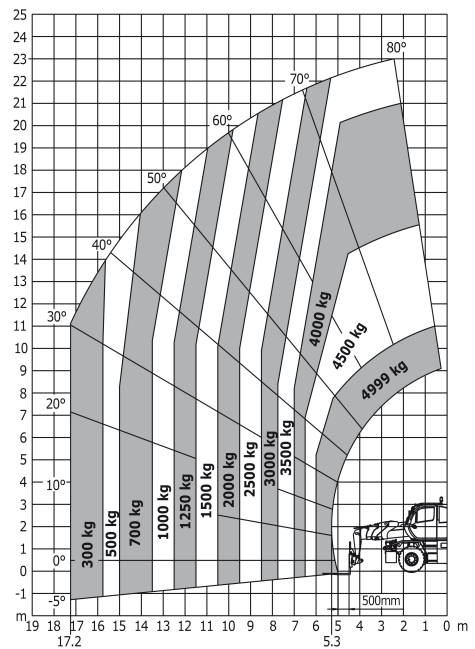



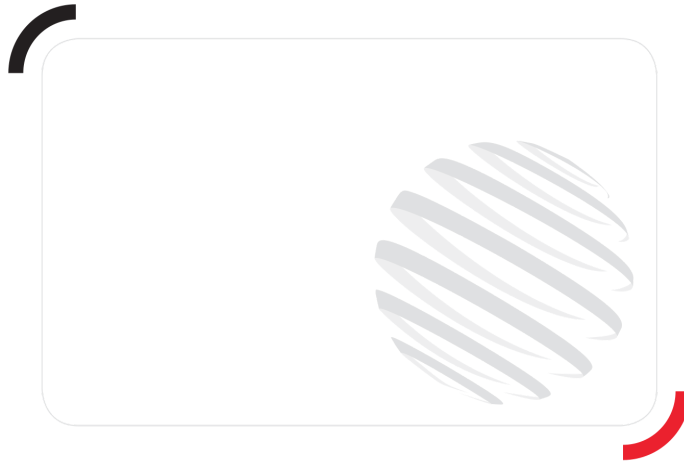

Siège Social

430 rue de l'Aubinière - 44150 Ancenis Cedex - France

Tel: +33(0)2 40 09 10 11 - Fax: +33 (0)2 40 09 10 97

[www.manitou.com](http://www.manitou.com)



This brochure describes versions and configuration options for Manitou products which may be fitted with different equipment. The equipment described in this brochure may be standard, optional or not available depending on version. Manitou reserves the right to change the specifications shown and described at any time and without prior warning. The manufacturer is not liable for the specifications given. For more information, contact your Manitou dealer. Non-contractual document. Product descriptions may differ from actual products. List of specifications is not comprehensive. The logos and visual identity of the company are the property of Manitou and may not be used without authorisation. All rights reserved. The photos and diagrams contained in this brochure are provided for information only.

MANITOU BF SA - Limited company with board of directors - Share capital: 39,668,399 euros - 857 802 508 RCS Nantes