

**MANISCOPIC**

**MT 1840**

**PRIVILEGE**





- Maximum lifting height: 17.50 m
- Capacity: 4000 kg
- Maximum forward reach: 13.17 m
- Torque convertor
- Hydraulic stabilizers
- Frame levelling:  $\pm 9^\circ$



**MT 1840**

**PRIVILEGE**

 **Lifting capacity** .....4000 kg  
at 500 mm from forks heels.  
Tipping load at maximum reach :  
with stabilizers .....950 kg  
Tear out force with bucket  
to ISO 8313 .....8000 daN

 **Lifting height** .....17.50 m  
**Times : unladen / loaded (in s)**  
Lifting (standard) .....17/17.1  
Lifting (EP) .....12.1/12.2  
Lowering.....14.5/14.3  
Extension boom.....27.5/33  
Retraction boom .....26.4/25.5  
Crowd.....4.3  
Dump.....4

 **Tyres**.....440/80-24

 **Forks (mm)**  
Length .....1200  
Width x thickness .....125 X 50  
Maximum distance between forks .....1040  
Carriage rotation .....126°

 **Multidisc brakes - hydraulically assisted on both axles**

 **PERKINS Engine**  
Deutz TD 3.6 L  
75 PK  
Direct injection  
Water cooling

 **Transmission**.....Torque convertor  
Electro-hydraulic reversing shift  
4 speeds forward and reverse  
Maximum travel speed (km/h).....25

 **Hydraulics**  
Pump.....gear type  
Pressure/capacity .....270 bars/170 l/mn

 **Capacities**  
Cooling system .....20 l.  
Engine oil .....10.9 l.  
Hydraulic oil.....135 l.  
Transmission oil .....23 l.  
Fuel tank.....140 l.

 **Weight unladen** .....11380 kg  
**Overall width** .....2.40 m  
**Overall height** .....2.50 m  
**Turning radius (outside wheels)** .....3.99 m  
**Overall Length** .....6.27 m  
**Ground clearance** .....0.44 m  
**Drawbar pull** .....10300 daN

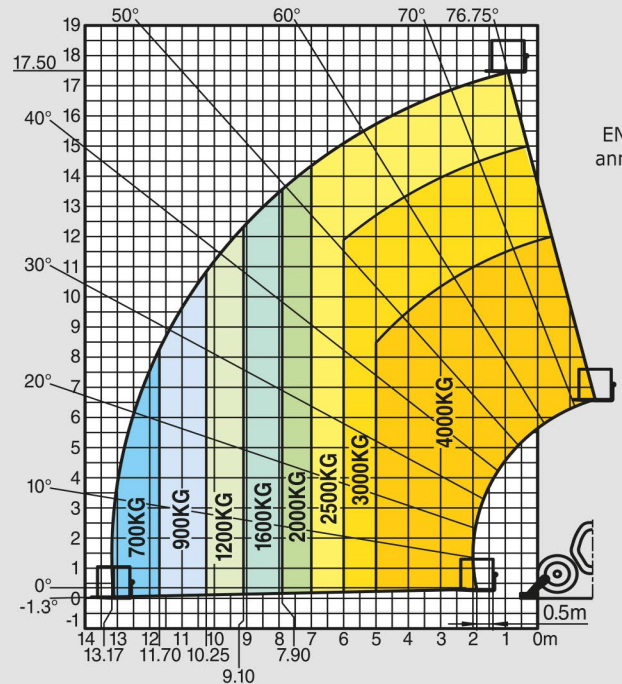

Under  
EN 1459  
annexe B

A	1200
B	3070
C	2044
C1	1929
D	6270
D1	6159
D2	4886
E	7473
F	1960
F1	1960
G	437
G1	420
G2	433
G3	302
H	9°
H1	9°
I	1160
J	892
K	1040
L	50
N	1908
O	125
P2	37°
P3	34°
R	3779
S	8780
T	4307
U1	2505
U2	2693
V	5592
V1	1285
V2	3998
22	2397
W1	3793
W2	1134
W3	2422
Y	12°
Z	114°

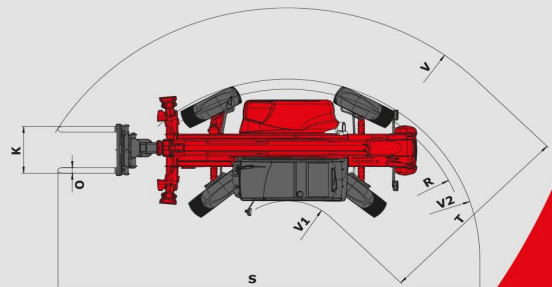
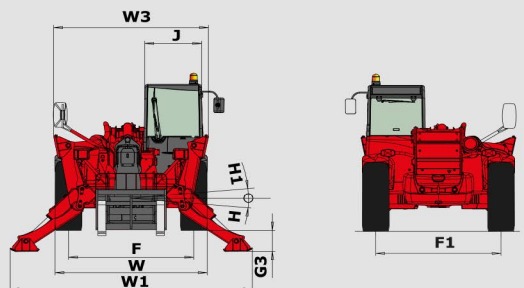
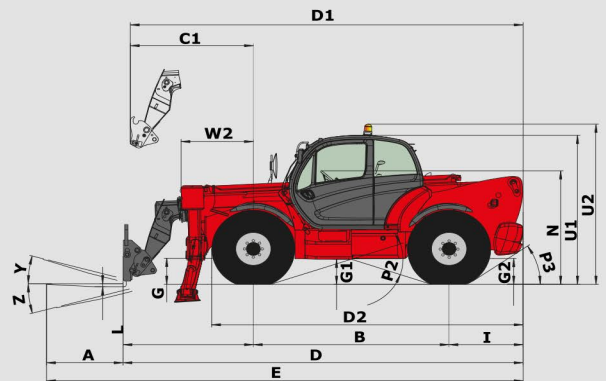

The specifications contained herein shall not bind the manufacturer and are subject to change without notice. This equipment described in this leaflet may be standard, optional, or unavailable, depending on the versions. For more details, contact your MANITOU dealer.

